

Content

A-Z



# OWNER'S MANUAL. BMW 2 SERIES GRAN COUPE.







# WELCOME TO BMW.

## Owner's Manual.

Thank you for choosing a BMW.

The more familiar you are with the vehicle, the better control you will have on the road.

Read the Owner's Manual before you start driving your new vehicle. Also use the Integrated Owner's Manual in the vehicle. It contains important information on vehicle operation that will help you make full use of your vehicle's technical features. The manual also contains information designed to enhance operating reliability and traffic safety, and to contribute to maintaining the value of the vehicle.

At the time of production at the plant, the printed Owner's Manual is the most current resource. After a vehicle software update – such as a Remote Software Upgrade – the Integrated Owner's Manual for the vehicle will contain the latest information.

You can find supplementary information in the additional brochures in the onboard literature.

We wish you a safe and enjoyable ride.

# TABLE OF CONTENTS

After a vehicle software update – such as a Remote Software Upgrade – the Integrated Owner's Manual for the vehicle will contain the latest information.

## ! Notes

Information .....	6
-------------------	---

## 🔑 Quick reference

Getting in .....	16
Set-up and use .....	19
On the road .....	22

## 👉 Controls

Dashboard .....	30
Sensors of the vehicle .....	34
Operating state of the vehicle .....	39
BMW iDrive .....	43
BMW Remote Software Upgrade .....	56
Personal settings .....	60
Opening and closing .....	68
Seats, mirrors and steering wheel .....	96
Transporting children safely .....	110
Driving .....	117
Displays .....	132
Light and view .....	151
Safety .....	164
Driving stability control systems .....	208
Driver assistance systems .....	213
Parking .....	239
Driving comfort .....	269
Climate control .....	270
Interior equipment .....	282
Storage compartments .....	291
Cargo area .....	295

## Driving tips

Things to remember when driving .....	302
Saving fuel .....	308

## Mobility

Refueling .....	314
Wheels and tires .....	316
Engine compartment .....	347
Operating fluids .....	350
Maintenance .....	357
Replacing components .....	360
Breakdown Assistance .....	364
Vehicle care .....	371

## Reference

Technical data .....	378
Appendix .....	381
Everything from A to Z .....	382

# Information

## Using this Owner's Manual

### Orientation

The fastest way to find information on a particular topic is by using the index.

For an overview of the vehicle, we recommend reading the Quick Reference Guide in the Owner's Manual.

### Validity of the Owner's Manual

#### Production of the vehicle

At the time of production at the plant, the printed Owner's Manual is the most current resource.

Depending on the national-market version, there may be differences between the vehicle's printed Owner's Manual and the Integrated Owner's Manual due to updates made after going to print.

Depending on national-market version, information on updates may be provided in the appendix to the vehicle's printed Owner's Manual or in the Safety Booklet.

#### After a software update in the vehicle

After a vehicle software update, for example, via Remote Software Upgrade, the Integrated Owner's Manual for the vehicle will contain the latest information, depending on the national-market version.

Before setting off, make sure that the Integrated Owner's Manual is available and up-to-date.

### Owner's Manual for Navigation, Entertainment, Communication

The Owner's Manual for Navigation, Entertainment, and Communication can be obtained as

a printed book from an authorized service center.

Depending on national-market version, these topics are also covered in the Integrated Owner's Manual for your vehicle.

## Media at a glance

### Principle

The Owner's Manual and information about the vehicle are provided in various ways. Depending on national-market version, the Owner's Manual is provided as follows:

- ▶ Integrated Owner's Manual in the vehicle.
- ▶ Printed Owner's Manual.
- ▶ Safety booklet.

Depending on availability in the respective country, additional information about the vehicle is provided as follows:

- ▶ Online: [driversguide.bmw.com](https://www.bmw.com/driversguide).
- ▶ In the app: BMW Driver's Guide.

The current version can be printed out directly, or a printable version of the Owner's Manual can be downloaded.

### Printed Owner's Manual

The printed Owner's Manual shows all standard, country-specific, and optional equipment that is currently available, or may become available in the future, for specific models.

Depending on vehicle equipment and national-market version, a Safety Booklet may be provided with the vehicle instead of the printed Owner's Manual. If necessary, the printed Owner's Manual can be obtained from Service.

## Safety Booklet

The Safety Booklet contains important general instructions and specific safety information.

Depending on vehicle equipment and national-market version, a printed Owner's Manual may be provided in the vehicle instead of the Safety Booklet.

## Integrated Owner's Manual in the vehicle

### Principle

The Integrated Owner's Manual shows all standard, country-specific, and optional equipment that is currently available, or may become available in the future, for specific models. The Integrated Owner's Manual can be displayed on the control display.

### Functional requirement

The Integrated Owner's Manual is provided depending on national-market version.

### Selecting the Owner's Manual

1. To select the Integrated Owner's Manual, go through the menu as follows: Apps menu / "All" / "Owner's Manual".
2. Select the desired method for accessing the contents.

## Context help

### General information

The Integrated Owner's Manual can be accessed from any menu. Depending on the selected function, either the associated description or the main menu of the Integrated Owner's Manual will be displayed.

### Selecting context help from a menu

1. To bring up the Context Help menu, press and hold the desired menu option.
2. "General help"

### Selecting context help from a Check Control message

Directly from the Check Control message on the control display:

"Owner's Manual"

### After a software update in the vehicle

After a vehicle software update, for example, via Remote Software Upgrade, the Integrated Owner's Manual for the vehicle will contain the latest information, depending on the national-market version.

Before setting off, make sure that the Integrated Owner's Manual is available and up-to-date.

### BMW Driver's Guide app

The BMW Driver's Guide app shows all standard, country-specific, and optional equipment that is currently available, or may become available in the future, for specific models. The app can be displayed on smartphones and tablets.

### BMW Driver's Guide Web

The BMW Driver's Guide website shows all standard, country-specific, and optional equipment that is currently available, or may become available in the future, for specific models. The BMW Driver's Guide Web can be displayed in any current browser.

### Printable Owner's Manual

The current version can be printed out directly as follows. A printable version of the Owner's Manual containing detailed information and instructions can also be downloaded.

- ▶ Online: [driversguide.bmw.com](http://driversguide.bmw.com).
- ▶ In the app: BMW Driver's Guide.

### Supplementary documentation

The media included with the Owner's Manual is supplemented by additional documents, e.g.,

Supplementary Owner's Manuals, brochures, or inserts. Supplementary Owner's Manuals or brochures contain, for example, information on special models or information that must be communicated in printed form due to legal requirements. Inserts may include different information than that given in the media included with the Owner's Manual. Follow all additional documents that may be enclosed with the on-board literature.

## Additional sources of information

### Authorized service center



An authorized service center, e.g., a BMW dealer or service center, will be happy to answer any questions you may have.

### Internet

Vehicle information and general information on BMW, for instance, on technology, are available on the Internet: [www.bmwusa.com](http://www.bmwusa.com).

## Icons and displays

### Icons in the Owner's Manual

Icon	Meaning
	Precautions that must be followed in order to avoid the possibility of injury to yourself and to others as well as serious damage to the vehicle.
	Recycling information.
"..."	Texts in vehicle used to select individual functions.

Icon	Meaning
>...<	Verbal instructions to use with the voice activation system.
>>...<<	Responses generated by the voice activation system.

### Action steps

Action steps to be carried out are presented as a numbered list. These steps must be carried out in the order shown.

1. First action step.
2. Second action step.

### Bulletpoint lists

Items or actions without strict order or alternative options are shown as a bulletpoint list.

- ▷ First possibility.
- ▷ Second possibility.

### Icons on vehicle parts

 This symbol on a vehicle component indicates that further information on the component is available in the Owner's Manual.

## Vehicle features and options

This Owner's Manual shows all standard, country-specific, and optional equipment that is currently available, or may become available in the future, for specific models, i.e., model series. Therefore, this Owner's Manual also describes and illustrates equipment, systems and functions that are not available in a vehicle, for example due to the following situations:

- ▷ Selected optional equipment.
- ▷ National-market version or national-market equipment.
- ▷ Options for later release and software update.

This also applies to safety functions and systems.

Before starting a journey, verify whether the described equipment or function is available in the vehicle. For information on whether a function is currently available in the vehicle or when the function can be installed in the vehicle, contact an authorized service center or another qualified service center or repair shop.

A claim for the availability of equipment, a system or a function in the vehicle cannot be derived based on the description in the Owner's Manual.

When using these functions and systems, the applicable laws and regulations must be observed.

For any equipment and models not described in this Owner's Manual, refer to any supplementary documentation included, e.g., Supplementary Owner's Manuals, inserts.

An authorized service center is happy to answer any questions that you may have about the features and options applicable to your vehicle.

## Status of the Owner's Manual

### Basic information

The manufacturer of the vehicle pursues a policy of constant development to ensure that our vehicles continue to embody the highest quality and safety standards. In rare cases, therefore, the features described in this Owner's Manual may deviate from those in the vehicle.

### Validity of the Owner's Manual

#### Production of the vehicle

At the time of production at the plant, the printed Owner's Manual is the most current resource.

Depending on the national-market version, there may be differences between the vehicle's printed Owner's Manual and the Integrated Owner's Manual due to updates made after going to print.

Depending on national-market version, information on updates may be provided in the appendix to the vehicle's printed Owner's Manual or in the Safety Booklet.

### After a software update in the vehicle

After a vehicle software update, for example, via Remote Software Upgrade, the Integrated Owner's Manual for the vehicle will contain the latest information, depending on the national-market version.

Before setting off, make sure that the Integrated Owner's Manual is available and up-to-date.

## For your own safety

### Intended use

Heed the following when using the vehicle:

- ▷ Owner's Manual and Safety Booklet, if applicable.
- ▷ Information on the vehicle. Do not remove stickers.
- ▷ Technical vehicle data.
- ▷ The traffic, speed, and safety laws where the vehicle is driven.
- ▷ Vehicle documents and statutory documents.

### Warranty

Your vehicle is technically configured for the operating conditions and registration requirements applying in the country of first delivery also known as homologation. If your vehicle is to be operated in a different country it might be necessary to adapt your vehicle to potentially differing operating conditions and permit

requirements. Noncompliance with homologation requirements in a certain country may affect warranty coverage. Please consult the New Vehicle Limited Warranty Booklet for further information on warranty matters.

## Maintenance and repairs

Advanced technology, for instance the use of modern materials and high-performance electronics, requires suitable maintenance and repair work.

The vehicle manufacturer therefore recommends having corresponding work performed by an authorized service center, e.g., a BMW dealer or service center. If a different repair shop is selected, BMW recommends selecting a workshop that performs corresponding work such as maintenance and repair according to BMW specifications with properly trained personnel. In the Owner's Manual, such workshops are referred to as "another qualified service center or repair shop".

If work is not carried out properly, for instance maintenance and repair, there is a risk of subsequent damages and related safety risks.

Improperly performed work on the vehicle paintwork can lead to a failure or fault of components, e.g., the radar sensors, and thereby result in a safety hazard.

## Parts and accessories

BMW recommends the use of parts and accessories products approved by BMW.

Approved parts and accessories, and advice on their use and installation are available from an authorized service center.

BMW parts and accessories were tested by BMW for their safety and suitability in BMW vehicles.

BMW warrants genuine BMW parts and accessories.

BMW does not evaluate whether each individual product from another manufacturer can be used with BMW vehicles without presenting a

safety hazard, even if a country-specific official approval was issued. BMW does not evaluate whether these products are suitable for BMW vehicles under all usage conditions.

## California Proposition 65 Warning

For vehicles sold in California the California law requires vehicle manufacturers provide the following warning:

### WARNING

Engine exhaust and a wide variety of Automobile components and parts, including components found in the interior furnishings in a vehicle, contain or emit chemicals known to the State of California to cause cancer and birth defects and reproductive harm. In addition, certain fluids contained in vehicles and certain products of component wear contain or emit chemicals known to the State of California to cause cancer and birth defects or other reproductive harm. Battery posts, terminals and related accessories contain lead and lead compounds. Batteries also contain other chemicals known to the State of California to cause cancer. Wash your hands after handling. Used engine oil contains chemicals that have caused cancer in laboratory animals. Always protect your skin by washing thoroughly with soap and water. For more information go to [www.P65Warnings.ca.gov/passenger-vehicle](http://www.P65Warnings.ca.gov/passenger-vehicle).

### WARNING

Operating, servicing and maintaining a passenger vehicle or off-highway motor vehicle can expose you to chemicals including engine exhaust, carbon monoxide, phthalates, and lead, which are known to the State of California to cause cancer and birth defects or other reproductive harm. To minimize exposure, avoid breathing exhaust, do not idle the engine except as necessary, service your

vehicle in a well-ventilated area and wear gloves or wash your hands frequently when servicing your vehicle. For more information go to [www.P65Warnings.ca.gov/passenger-vehicle](http://www.P65Warnings.ca.gov/passenger-vehicle).

## Service and warranty

We recommend that you read this publication thoroughly. Your vehicle is covered by the following warranties:

- ▶ New Vehicle Limited Warranty.
- ▶ Rust Perforation Limited Warranty.
- ▶ Federal Emissions System Defect Warranty.
- ▶ Federal Emissions Performance Warranty.
- ▶ California Emission Control System Limited Warranty.

Detailed information about these warranties is listed in the New Vehicle Limited Warranty Booklet.

Your vehicle has been specifically adapted and designed to meet the particular operating conditions and homologation requirements in your country and continental region in order to deliver the full driving pleasure while the vehicle is operated under those conditions. If you wish to operate your vehicle in another country or region, you may be required to adapt your vehicle to meet different prevailing operating conditions and homologation requirements. You should also be aware of any applicable warranty limitations or exclusions for such country or region. In such case, please contact Customer Relations for further information.

## Maintenance

Maintain the vehicle regularly to sustain the road safety, operational reliability and the New Vehicle Limited Warranty.

Specifications for maintenance measures:

- ▶ BMW maintenance system.

Maintenance, refer to page 357.

- ▶ Maintenance Booklet, available online and accessible via a QR code in the New Vehicle Limited Warranty Booklet.
- ▶ Warranty and Service Guide Booklet for Canadian models.

If the vehicle is not maintained or is improperly maintained, this could result in serious damage to the vehicle.

A failure to maintain your vehicle or improper maintenance may affect your warranty coverage. Please consult the New Vehicle Limited Warranty Booklet for further information on warranty matters.

Refer to section on engine oil change regarding recommended service intervals for oil changes.

## Data memory

### General information

Electronic control devices are installed in the vehicle. Electronic control units process data they receive from vehicle sensors, self-generate or exchange with each other. Some control units are necessary for the vehicle to function safely or provide assistance while driving, for instance driver assistance systems. Furthermore, control units facilitate comfort or infotainment functions.

BMW NA collects, uses, discloses, or otherwise processes your personal information in accordance with its privacy policy, which is available at <https://my.bmwusa.com/privacypolicy>.

### Personal reference

Each vehicle is marked with a unique vehicle identification number. Depending on the country, the vehicle owner can be identified with the vehicle identification number, license plate and corresponding authorities. In addition, there are other ways to associate data collected

from the vehicle with the driver or vehicle owner, e.g., the ConnectedDrive account used.

## Operating data in the vehicle

Control units process data to operate the vehicle.

This includes, for example:

- ▶ Status messages for the vehicle and its individual components, e.g., wheel RPM, wheel speed, deceleration, lateral acceleration, engaged seat belt indicator.
- ▶ Ambient conditions, e.g., temperature, rain sensor signals.

The processed data is only processed in the vehicle itself while the vehicle is being operated. Data is not stored beyond the operating time.

Electronic components, e.g. control units and vehicle keys, contain components for storing technical information. Information about the vehicle condition, component usage, maintenance recommendations, events or faults can be stored temporarily or permanently.

This information generally documents the state of a component, a module, a system, or the surrounding area, for instance:

- ▶ Operating states of system components such as fill levels, tire pressure, battery status.
- ▶ Malfunctions on important system components, e.g., lights and brakes.
- ▶ Responses by the vehicle to special driving situations such as airbag deployment or engagement of the driving stability control systems.
- ▶ Information on vehicle-damaging events.

The data is required to perform the control unit functions. Furthermore, it also serves to detect and correct malfunctions, and helps the vehicle manufacturer to optimize vehicle functions.

The majority of this data is stored temporarily and is only processed within the vehicle itself. In some circumstances the vehicle may store

some data in event or fault memories for an additional but limited period of time.

When servicing, for instance during repairs, service processes, warranty cases, and quality assurance measures, this technical information can be read out from the vehicle together with the vehicle identification number.

An authorized service center or another qualified service center or repair shop can read out the information. The diagnostic socket required by law in the vehicle is used to read out data.

The data is collected, processed, and used by the relevant organizations in the service network. The data documents technical conditions of the vehicle, which can be used to determine vehicle maintenance status, and facilitate quality improvement.

Vehicle fault and event memories can be reset by an authorized service center or another qualified service center or repair shop when performing repair or servicing work.

## Data entry and data transfer into the vehicle

### General information

Depending on the vehicle equipment, comfort and individual settings can be stored in the vehicle and modified or reset at any time.

This includes, for example:

- ▶ Settings for the seat and steering wheel positions.
- ▶ Chassis and air conditioning settings.

If necessary, data can be transferred to the entertainment and communication system of the vehicle, for instance via smartphone.

This includes the following depending on the respective equipment:

- ▶ Multimedia data such as music, films or photos for playback in an integrated multimedia system.
- ▶ Address book data for use in conjunction with an integrated hands-free system or an integrated navigation system.
- ▶ Entered navigation destinations.
- ▶ Data on the use of Internet services.

This data can be stored locally in the vehicle or is found on a device that has been connected to the vehicle, e.g., a smartphone, USB stick or MP3 player. If this data is stored in the vehicle, it can be deleted at any time.

This data is only transmitted to third parties upon personal request as part of the use of online services. The transmission depends on the selected settings for the use of the services.

## Incorporation of mobile devices

Depending on the vehicle equipment, mobile devices connected to the vehicle, for instance smartphones, can be controlled via the vehicle operating elements.

The sound and picture from the mobile devices can be played back and displayed through the multimedia system. Certain information is transferred to the mobile devices at the same time. Depending on the type of incorporation, this includes, for instance, position data and other general vehicle information. This optimizes the way in which selected apps, for instance navigation or music playback, work.

There is no further interaction between the mobile device and the vehicle such as active access to vehicle data.

How the data will be processed further is determined by the provider of the particular app being used. The extent of the possible settings depends on the respective app and the operating system of the mobile device.

## Services

### General information

If the vehicle has a wireless network connection, it will enable data to be exchanged between the vehicle and other systems. The wireless network connection is realized via an in-vehicle transmitter and receiver unit or via personal mobile devices brought into the vehicle, for instance smartphones. This wireless network connection enables 'online functions' to be used. These include online services and apps supplied by the vehicle manufacturer or by other providers.

### Services from the vehicle manufacturer

Where online services from the vehicle manufacturer are concerned, the corresponding functions are described in the appropriate place, for instance the Owner's Manual or manufacturer's web page. You may find out more about BMW NA privacy practices on our website, specifically <https://my.bmwusa.com/privacypolicy>. BMW NA may collect, use, disclose, or otherwise process your personal information to provide you with its services. However, you may deactivate optional information collection using your vehicle's Data Privacy menu or completely disable all information collection by calling BMW NA.

### Services from other providers

When using online services from other providers, these services are the responsibility of the relevant provider and subject to their data privacy conditions and terms of use. The vehicle manufacturer has no influence on the content exchanged during this process. Information on the way in which personal data is collected and used in relation to services from third parties, the scope of such data, and its purpose, can be obtained from the relevant service provider.

## Event Data Recorder

This vehicle is equipped with an event data recorder. The main purpose of this component is to record, in certain crash or near crash-like situations, such as an air bag deployment or hitting a road obstacle, data that will assist in understanding how a vehicle's systems performed. The event data recorder is designed to record data related to vehicle dynamics and safety systems for a short period from up to 30 seconds, typically less.

The event data recorder in this vehicle is designed to record the following data, for example:

- ▶ How various systems in the vehicle were operating.
- ▶ Whether or not the driver and passenger safety belts were fastened.
- ▶ How far, if at all, the driver was depressing the accelerator and/or brake pedal.
- ▶ How fast the vehicle was traveling.

These data can help provide a better understanding of the circumstances in which crashes and injuries occur.

Data from the event data recorder are recorded by the vehicle only if a nontrivial crash situation occurs; no data are recorded under normal driving conditions and no personal data, e. g., name, gender, age, and crash location, are recorded.

However, other parties, such as law enforcement, could combine the recorded data with the type of personally identifying data routinely acquired during a crash investigation.

To read the recorded data, special equipment is required, and access to the vehicle or the event data recorder is needed. In addition to the vehicle manufacturer, other parties, such as law enforcement, that have the special equipment, can read the information if they have access to the vehicle or the event data recorder.

## Vehicle identification number

### General information

Depending on the national-market equipment, the vehicle identification number is located in different positions in the vehicle. This chapter describes all possible positions for the series.

### Engine compartment

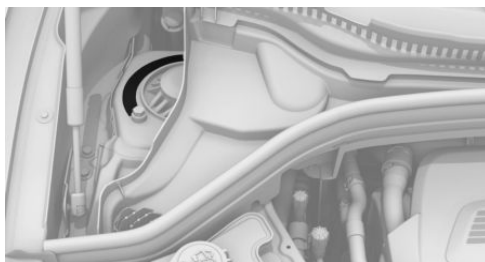

The engraved vehicle identification number can be found in the engine compartment, on the right-hand side of the vehicle.

### Right nameplate



The vehicle identification number can be found on the nameplate, on the right-hand side of the vehicle.

## Left nameplate



The vehicle identification number can be found on the nameplate, on the left-hand side of the vehicle.

## Windshield



The vehicle identification number can also be found behind the windshield.

## Reporting safety defects

### For US customers

The following only applies to vehicles owned and operated in the US.

If you believe that your vehicle has a defect which could cause a crash or could cause injury or death, you should immediately inform the National Highway Traffic Safety Administration NHTSA, in addition to notifying BMW of North America, LLC, P.O. Box 1227, Westwood, New Jersey 07675-1227, Telephone 1-800-831-1117.

If NHTSA receives similar complaints, it may open an investigation, and if it finds that a safety defect exists in a group of vehicles, it may order a recall and remedy campaign.

However, NHTSA cannot become involved in individual problems between you, your dealer, or BMW of North America, LLC.

To contact NHTSA, you may call the Vehicle Safety Hotline toll-free at 1-888-327-4236 (TTY: 1-800-424-9153); go to <http://www.safercar.gov>; or write to: Administrator, NHTSA, 1200 New Jersey Avenue, SE., Washington, DC 20590. You can also obtain other information about motor vehicle safety from <http://www.safercar.gov>.

### For Canadian customers

Canadian customers who wish to report a safety-related defect to Transport Canada, Defect Investigations and Recalls, may telephone the toll-free hotline 1-800-333-0510. You can also obtain other information about motor vehicle safety from <http://www.tc.gc.ca/roadsafety>.





# Getting in

## Opening and closing

### Vehicle key



Buttons on the vehicle key.

Icon	Meaning
	Unlock the vehicle.
	Lock the vehicle. Pre-conditioning.
	Open the cargo area.
	Panic mode. Pathway lighting.

### Access to vehicle interior

#### Unlocking with the vehicle key

 Press the unlock button on the vehicle key.

If only the driver's door and fuel filler flap have been unlocked due to the settings in place, press the button on the vehicle key again to unlock the other vehicle access points.

#### Locking with the vehicle key

1. Close the driver's door.
2.  Press the lock button on the vehicle key.

#### Buttons for the central locking system

##### Overview

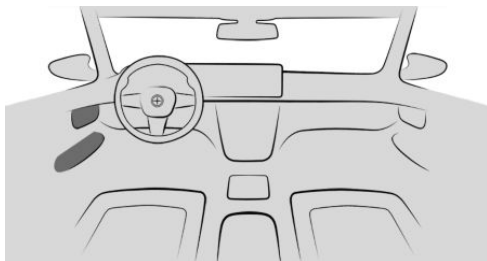

The central locking buttons are located on the front door.

 The lock button.

 The unlock button.

#### Locking the vehicle

 With the front doors closed, press the lock button on the front door.



The fuel filler flap remains unlocked.

#### Unlocking the vehicle

 Press the unlock button on the front door.

## Panic mode

You can trigger the alarm system if you find yourself in a dangerous situation.

- ▶  Press and hold the panic mode button on the vehicle key for at least 3 seconds.
- ▶  Press the panic mode button on the vehicle key three times in quick succession.

To switch off the alarm: press any button.

## Access to the cargo area

### Opening the cargo area

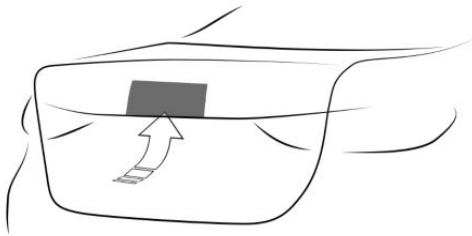

- ▶ Unlock the vehicle. To open, press the button on the outside of the cargo area.
- ▶  On the vehicle key, press and hold the button for opening the cargo area for approx. 1 second.

### Closing the cargo area

Pull the cargo area lid downward using the recessed grips.

## Displays, operating elements

### In the vicinity of the steering wheel

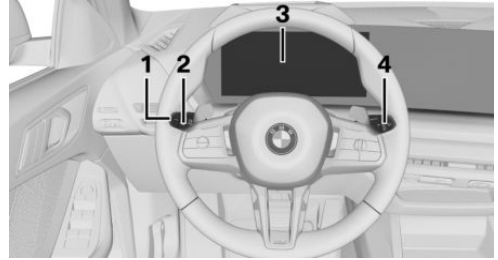

- 1 Light switch
- 2 High-beam headlights, turn signal
- 3 Instrument cluster
- 4 Wipers

### Indicator/warning lights

The indicator/warning lights can illuminate in a variety of combinations and colors.

Several of the lights are checked for proper functioning and illuminate temporarily when drive-ready state is turned on.

### Driver's door

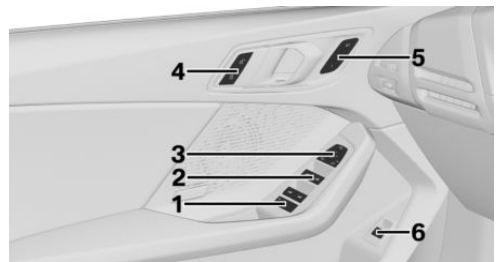

- 1 Safety switch
- 2 Power window
- 3 Operating the exterior mirrors
- 4 Central locking system

- 5 Seat memory
- 6 Cargo area

## Switch console



- 1 Start/Stop button
- 2 Defrost function
- 3 Rear window defroster
- 4 Vehicle settings menu
- 5 Parking brake
- 6 Selector lever

## BMW iDrive

### Principle

BMW iDrive is the vehicle's display and operating concept and includes a wide range of functions.

### Buttons on the control display

When operating the control display, the buttons on the control display illuminate.

Button	Function
	Go to the previous menu.
	Go to the Media menu.



Go to the previous menu.



Go to the Media menu.

Button	Function
	Bring up the Communication menu.
	Go to the Navigation menu.

Bring up the Communication menu.

Go to the Navigation menu.

## BMW Intelligent Personal Assistant

### Principle

The BMW Intelligent Personal Assistant is a personal assistant that enables natural voice operation of various vehicle functions.

### Activating the voice control system

1.  Briefly press the microphone button on the steering wheel.
2. Say the desired command.

### Canceling voice control

- ▶  Press the microphone button on the steering wheel again.
- ▶ Say the following command: ›Cancel‹

# Set-up and use

## Seats, mirrors and steering wheel

### Manually adjustable seats

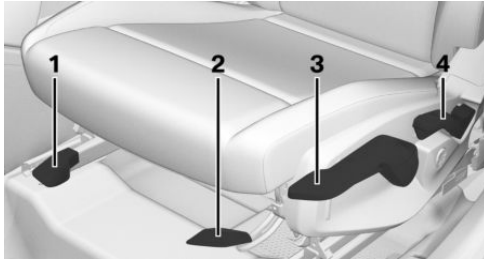

- 1 Longitudinal direction
- 2 Seat tilt
- 3 Height
- 4 Backrest tilt

### Electrically adjustable seats

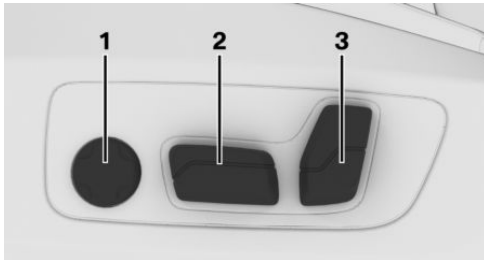

- 1 Lumbar support  
Depending on vehicle equipment: backrest width
- 2 Height/longitudinal direction/seat tilt
- 3 Backrest tilt

### Adjusting the head restraint

#### Adjusting the height

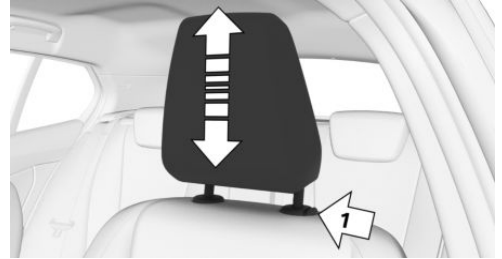

- ▶ To lower, press the release button on the backrest, then push the head restraint downward, arrow 1.
- ▶ To raise the height of the head restraint, push the head restraint upward.



#### Adjusting the height: M sport seat

The height of the head restraints cannot be set.

### Adjusting the exterior mirrors



Icon	Meaning
	Fold the exterior mirrors in and out.
	Adjust the exterior mirrors.

Icon	Meaning
	Select left exterior mirror. Automatic Curb Monitor.
	Select right exterior mirror.

## Adjusting the steering wheel

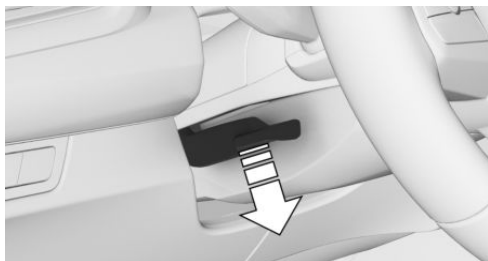

1. On the steering column, press the release lever all the way down.
2. Grip the steering wheel with both hands and move the steering wheel to a height and angle that suits the seat position.
3. Flip the lever back again.

## Infotainment

### Navigation and guidance



Guidance can be started via the quick search.

1. Go to the Navigation menu.
2. Select the search field.
3. Enter your desired destination.
4. Start destination guidance.  
More information may be displayed.

### Entertainment

The entertainment system can be operated using the volume button on the center console or using the control display.

In the center console:

Operating element	Function
	Turn volume button: adjust the volume. Press volume button: turn sound output on/off.
	Press once: changes the station/track.
	Press and hold: fast forward/rewind the track.

On the control display:

Button	Function
	Go to the Media menu. In the Media menu: change the entertainment source.

## Using the mobile phone

### General information

After the mobile phone is connected once to the vehicle, the mobile phone can be operated using iDrive and the steering wheel buttons.

Activate Bluetooth® on the mobile phone.

### Connecting via Bluetooth®

A mobile phone can be paired with the vehicle via Bluetooth.

1. Go through the menu as follows: Apps menu / "All" / "Mobile devices" / "Connect new device".  
Mobile phones in range are displayed on the control display.
2. Select the desired mobile phone.
3. Compare the control number shown on the control display with the control number on

the device display and confirm that they match.

4. If necessary, select connection mode:

"Continue with BMW iDrive"

The device is connected and displayed in the device list.

## Accepting a call

Depending on the equipment, incoming calls can be answered in several ways.

- ▶ Via iDrive:

 "Accept"



- ▶  Press the telephone function button on the steering wheel.

## Dialing a number

iDrive can be used to dial a telephone number.

1. Go through the menu as follows: Apps menu / "All" / "Telephone" / "Dial".
2. Enter the desired digits.
3.  Select the icon for calling. The connection is established via the mobile phone to which this function has been assigned.

# On the road

## Driving

### Drive-ready state

#### Overview

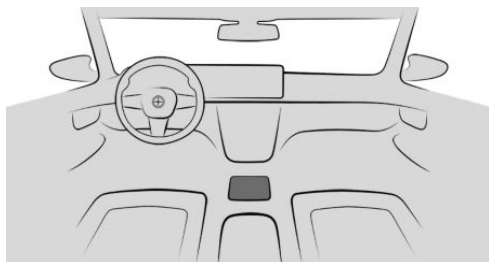

Start/Stop button.

#### Turning on the drive-ready state

1. Depress the brake pedal.
2. Press the Start/Stop button.

If READY is displayed in the instrument cluster, the Auto Start/Stop function is ready to start the engine automatically.

#### Turning off drive-ready state

1. When the vehicle is stationary, press the brake.
2. Engage the parking brake.
3. Press the Start/Stop button.

The READY indicator goes out and a signal tone sounds.

The drive-ready state is switched off automatically if the driver's seat belt is not buckled when the driver's door is opened.

### Auto Start/Stop function

The Auto Start/Stop function switches the engine off automatically while stationary to save fuel. The engine starts automatically under the following preconditions:

- ▶ By releasing the brake pedal.
- ▶ When Automatic Hold is activated: step on the accelerator pedal.
- ▶ By the driver assistance systems activated, depending on vehicle equipment and driving situation.

### Automatic transmission

#### Engaging selector lever position D, N, R, S, L

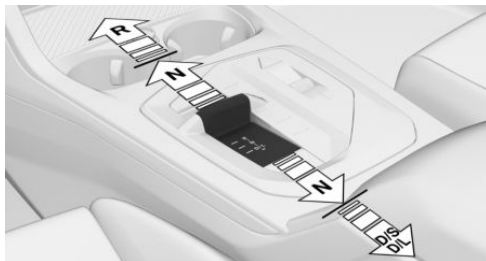

- ▶ D is drive.
- ▶ N Neutral.
- ▶ Reverse R.
- ▶ With shift paddles: S is Sport program.
- ▶ Without shift paddles: L LOW mode.

Depress and hold the brake pedal until ready to drive off, otherwise the vehicle will move when a gear position or reverse gear is engaged.

Only engage selector lever position R when the vehicle is stationary.

Sport program: the gearshift behavior is designed for a sportier driving behavior.

LOW mode: the engine braking effect is increased and acceleration is quicker.

### Engaging selector lever position P

Only press parking brake button P when the vehicle is stationary.



-  Press the parking brake button on the center console.  
The parking brake is applied and the parking lock is engaged.

## Parking brake

### Setting the parking brake

-  To engage the parking brake, press the parking brake button on the center console.

The LED on the button and the indicator light in the instrument cluster are illuminated.

The parking brake is applied and parking lock is engaged.

### Releasing the parking brake

-  Press the parking brake button with selector lever position P engaged and drive-ready state on.

The LED and the indicator light go out.

The parking brake is released.

## Light and view

### Turn signal, high-beam headlights, headlight flasher

#### Turn signal

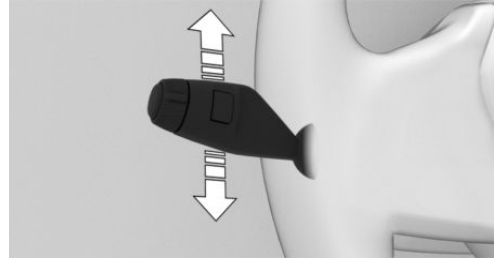

- ▶ To flash the turn signal, push the turn signal lever up or down past the resistance point.
- ▶ For one-touch signaling: Lightly tap the turn signal lever up or down.
- ▶ To flash the turn signal briefly: push the turn signal lever to the resistance point and hold it there for as long as you wish to indicate a turn.

#### High-beam headlights, headlight flasher

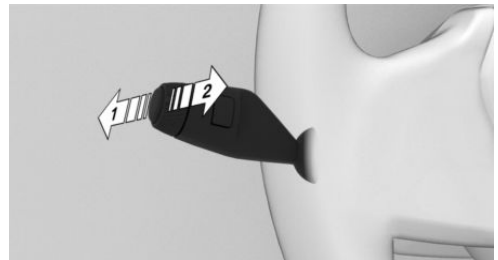





- ▶ To turn on the high-beam headlights, push the turn signal lever forward, arrow 1.

The high-beam headlights illuminate when the low-beam headlights are switched on.





- ▶ To turn off the high-beam headlights or operate the headlight flasher, pull the turn signal lever backward, arrow 2.



## Lights and lighting

### Buttons on turn signal lever

Icon	Function
	Exterior lighting menu.
	Low-beam headlights.
	Automatic headlight control.
	Exterior lighting off.

### Functions via iDrive

Icon	Function
	Automatic headlight control.
	Low-beam headlights.
	Exterior lighting off.
	High Beam Assistant.
	Parking lights.

Icon	Function
	Left roadside parking light.
	Right roadside parking light.

## Window wiper system

### Turning on window wiper system

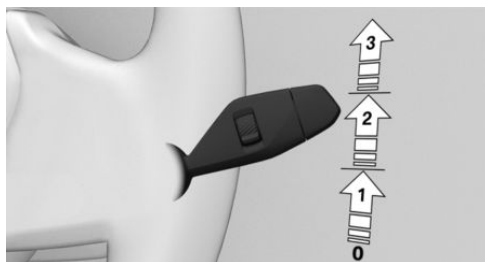

To turn on the wiper system, push the wiper lever upward to the desired position.

Position	Function
Position 0.	Rest position of wipers.
Position 1.	Rain sensor mode.
Position 2.	Normal wiper speed.
Position 3.	Fast wiper speed.

## Turning off the window wiper system and flick wipe

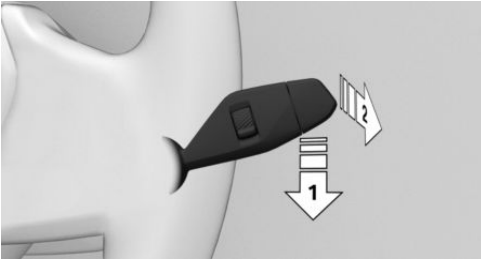

To turn off the wiper system, push the wiper lever down until it reaches position 0, arrow 1.

To flick wipe, proceed as follows:

- ▶ Push the wiper lever down from position 0, arrow 1.
- ▶ Push the wiper lever up from position 0 or position 1, arrow 2.

The wiper lever returns to its initial position when released.

## Activating/deactivating rain sensor

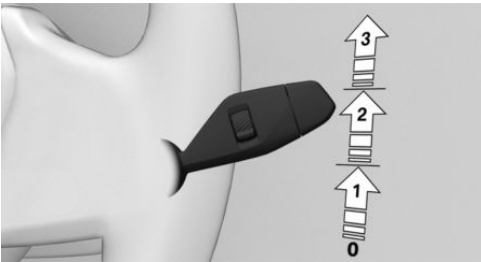

To activate the rain sensor: Push the wiper lever upward from position 0, arrow 1, once.

To deactivate the rain sensor: Push the wiper lever back to position 0.

## Adjusting the rain sensor sensitivity

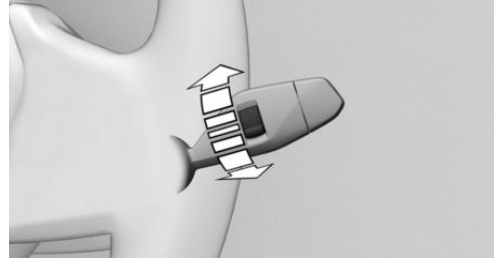

To adjust the sensitivity of the rain sensor, turn the thumbwheel on the wiper lever.

## Cleaning the windshield

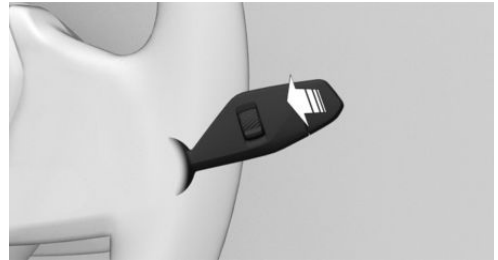













To clean the windshield, pull the wiper lever back.

## Climate control

### Climate control functions



#### Functions in the Climate menu

Icon	Function
	Turn the air conditioning system on/off.
AUTO	Automatic program.

Icon	Function
	Manual program.
	Temperature in the vehicle interior.
	Air flow.
	Air conditioning.
	Maximum cooling.
	Air recirculation mode.
	Automatic air recirculation.
	Fresh air.
	SYNC program.
	Seat heating.
	Steering wheel heating.
	Settings.

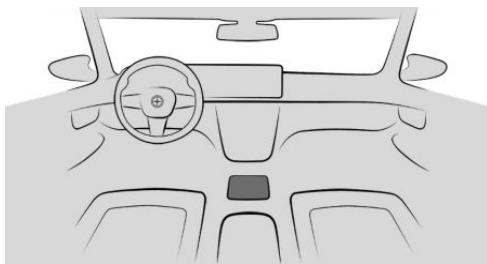
## Buttons, air conditioning system



Icon	Function
	Defrost function.
	Rear window defroster.

## Intermediate stop

### Refueling

#### Fuel filler cap

1. To open the fuel filler flap, press on the rear edge, arrow. The fuel filler flap opens.



2. Open the fuel filler cap counterclockwise.

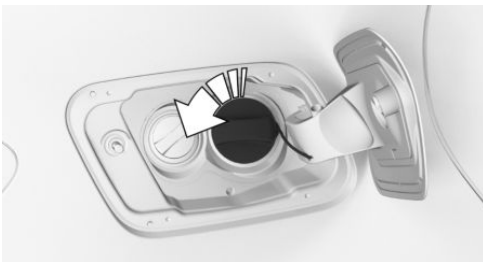

3. Place the fuel filler cap in the bracket on the fuel filler flap.



### Washer fluid



The washer fluid reservoir is located in the engine compartment on the right side of vehicle.

Use a mixture of tap water and windshield washer concentrate. If desired, a windshield washer concentrate containing antifreeze can be used.

Recommended minimum fill quantity: 0.5 US gal/2 liters.

To refill the engine oil, proceed as follows:

1. Opening the hood.  
To do so, pull the lever in the footwell twice.
2. Open the cap and refill the washer fluid.
3. Close the cover.

### Wheels and tires

#### Tire pressure specifications

The tire inflation pressure specifications can be found in the tire inflation pressure table in the printed Owner's Manual.

#### After correcting the tire pressure

If vehicle is equipped with the Tire Pressure Monitor, corrected tire pressures are applied automatically. Make sure that the correct tire settings have been made. When using tires not found in the tire inflation pressure specifications on the control display, reset the Tire Pressure Monitor.

If equipped with a flat tire monitor, reinitialize the flat tire monitor.

## Checking the tire pressure

Regularly check the tire inflation pressure and correct it as needed:

- ▶ At least twice a month.
- ▶ Before embarking on an extended trip.

## Electronic oil measurement

### Functional requirements

A current measured value is available after approx. 30 minutes of normal driving.

### Displaying the engine oil level

To display the engine oil level on the control display, go through the menu as follows: Apps menu / "Vehicle" / "Vehicle status" / "Engine oil level".

## Adding engine oil

### General information

Safely park the vehicle and switch off drive-ready state before adding engine oil.

### Adding engine oil

1. Opening the hood.
2. Open the lid counterclockwise.



3. Add engine oil.
4. Close the lid.

## Providing assistance

### Hazard warning system

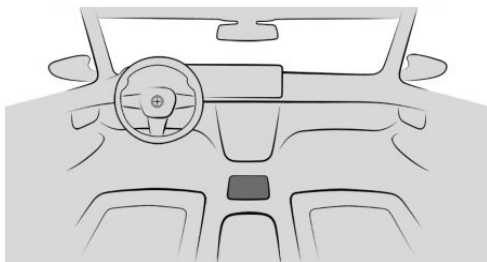

The button for the hazard warning system is located on the center console.

### BMW Assistance

Contact BMW Assistance for information and support for all aspects of the vehicle.

1. Go through the menu as follows: Apps menu / "All" / "BMW Assist".
2. Select the desired service, as necessary.  
A voice connection to the selected service is established.



# Dashboard

## Vehicle features and options

This chapter describes model-specific equipment, systems, and functions that are currently





available, or may become available in the future, even if they are not present in the vehicle.



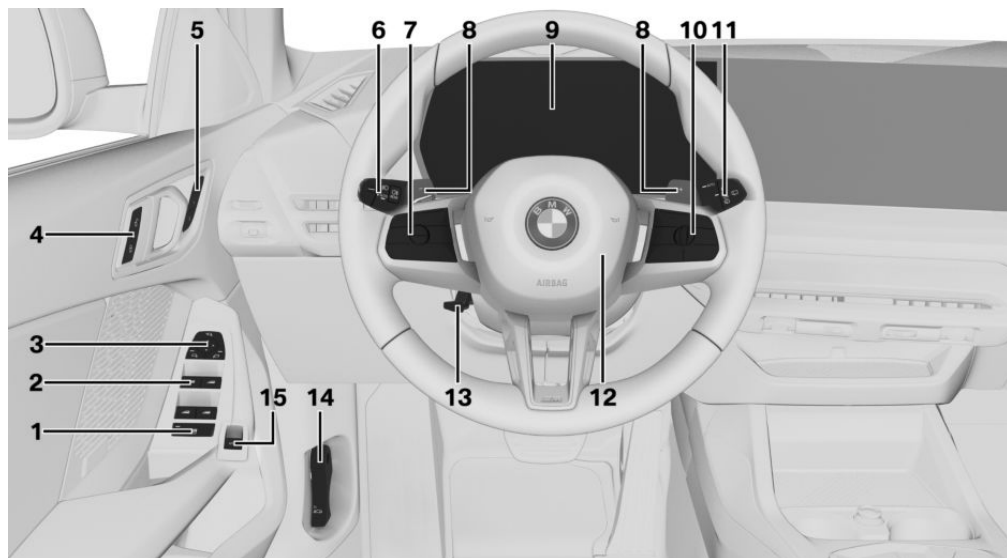

Additional information:

Vehicle equipment, refer to page 8.

## In the vicinity of the steering wheel



- 1  Safety switch 91
- 2  Power window 89
- 3 Operating the exterior mirrors 105
- 4 Buttons for the central locking system 85
  -  Unlocking the vehicle
  -  Locking the vehicle

- 5 Seating comfort features
  -  Memory function 108
- 6 Turn signal lever and light
  -  Turn signal 151
  -  High-beam headlights, headlight flasher 151
  -  Exterior lighting menu 154
  - High Beam Assistant 152



Low-beam headlights [155](#)



Driving lights automatic [155](#)



Exterior lighting off [155](#)

## 7 Steering wheel buttons, left



Turn speed control systems on/off [215](#)



Select speed control system [215](#)



Store speed [215](#)



Adjusting the speed [215](#)

## 8 Shift paddle, right and left [123](#)

## 9 Instrument cluster [44](#)

## 10 Steering wheel buttons, right



Settings, instrument cluster [44](#)  
Settings for Head-up display [132](#)



Volume, see Owner's Manual for Navigation, Entertainment and Communication [6](#)



Audio, see Owner's Manual for Navigation, Entertainment, Communication [6](#)



Voice control, BMW Intelligent Personal Assistant [50](#)



Telephone, see Owner's Manual for Navigation, Entertainment and Communication [6](#)



Selection of configuration menus for instrument cluster and Head-up display [44](#)  
Using selection lists [141](#)

Accessing and resetting trip data [146](#)

Resetting the G-Meter values [148](#)

## 11 Wiper lever



Wipers [160](#)



Rain sensor [161](#)



Cleaning the windshield [162](#)

## 12



Horn, entire surface

## 13

Adjusting the steering wheel [107](#)

## 14



Unlocking the hood [348](#)









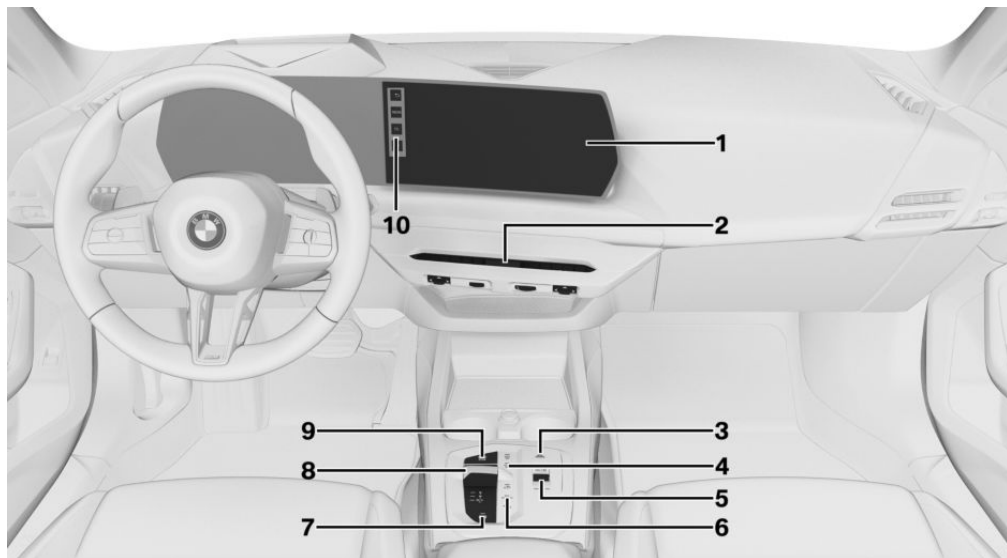



## 15



Opening and closing cargo area [82](#)

## In the vicinity of the center console



- 1 Control display [46](#)
- 2 Ventilation [270](#)
- 3  Hazard warning system [364](#)
- 4  Defrost function [275](#)
-  Rear window defroster [275](#)
- 5 Operating elements for entertainment system, see Owner's Manual for Navigation, Entertainment, and Communication [6](#)
-  Adjusting the volume
-  Station/title forward
-  Station/title back
- 6  Parking assistance systems [239](#)
-  My Modes [126](#)
-  Vehicle settings menu [50](#)
- 7  Parking brake [127](#)
- 8 Selector lever
- 9  Turning drive-ready state on/off [117](#)
- 10  Back
-  Media source

TEL





Telephone

NAV

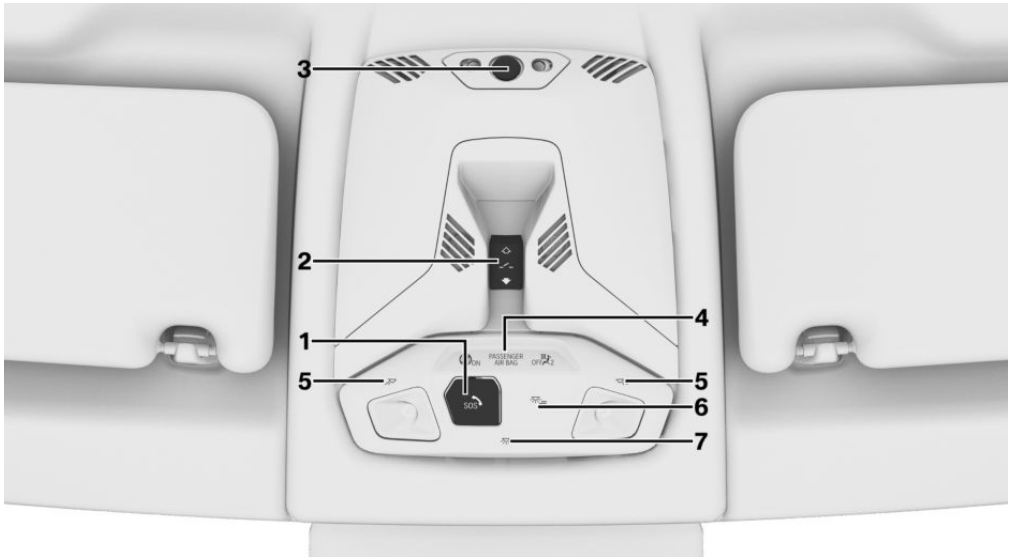
Navigation

## In the vicinity of the headliner



- |  |  |
|--|--|
| <p>1  Emergency Call, SOS <a href="#">364</a></p>                     | <p>6  Interior lighting menu <a href="#">50</a></p> |
| <p>2 <a href="#">Glass sunroof 92</a></p>  | <p>7  Interior lights <a href="#">158</a></p>       |
| <p>3 <a href="#">Interior camera 288</a></p>   |  |
| <p>4  Indicator light, front passenger airbag <a href="#">166</a></p> |  |
| <p>5  Reading lights <a href="#">159</a></p>                          |  |

# Sensors of the vehicle

## Vehicle features and options

This chapter describes model-specific equipment, systems, and functions that are currently available, or may become available in the future, even if they are not present in the vehicle.

Additional information:

Vehicle equipment, refer to page 8.

## Overview

Depending on the equipment, the following cameras and sensors are installed in the vehicle:

- ▶ Front camera.
- ▶ Camera behind the windshield.
- ▶ Exterior mirror cameras.
- ▶ Rear View Camera.
- ▶ Front radar sensor.
- ▶ Side radar sensors, front.
- ▶ Side radar sensors, rear.
- ▶ Ultrasonic sensors in the front/rear bumpers.
- ▶ Ultrasonic sensors at the sides.

## Cameras

### Front camera

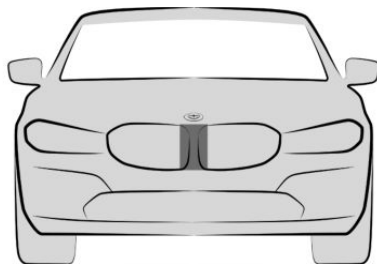

The front camera is located in the radiator grille.

### Camera behind the windshield

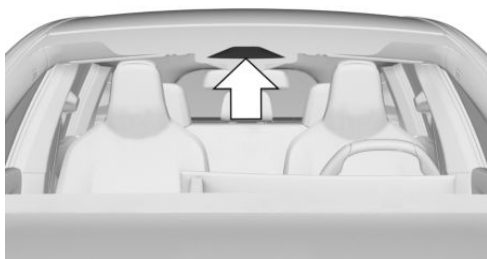

The camera behind the windshield is located near the interior mirror.

## Top view cameras

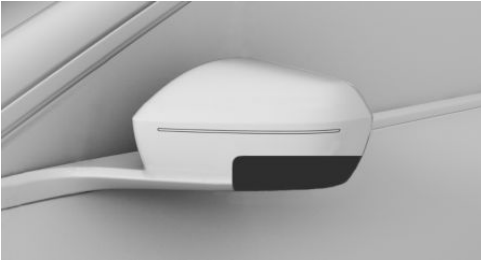

One exterior mirror camera is located at the bottom of each exterior mirror housing.

## Rear View Camera

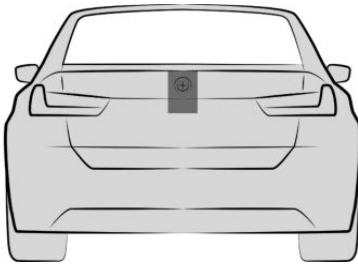

The Rear View Camera is located in the handle strip on the rear of the vehicle.

## Functional requirements of cameras

For the cameras to function correctly, the area around the cameras must be clean and free.

Additional information:

- ▷ Washing the vehicle, refer to page 371.
- ▷ Vehicle care, refer to page 373.

## System limits of the cameras

The cameras may not work properly, e.g., show something that is incorrect, in the following situations:

- ▷ In heavy fog, wet conditions, or snowfall.
- ▷ On steep hilltops or in sharp dips in the road.
- ▷ In tight curves.

- ▷ When the camera field of view is covered, for instance by a fogged up windshield or labels.
- ▷ If the camera lens is dirty or damaged.
- ▷ With exterior mirrors folded in.
- ▷ With open doors or open cargo area.
- ▷ When driving toward bright lights or strong reflections, e.g., setting sun.
- ▷ When it is dark outside.
- ▷ The camera has overheated due to excessive temperatures and temporarily turned off.
- ▷ During calibration of the camera immediately after vehicle delivery.

If applicable, a Check Control message will be displayed when the system limits are reached.

## Radar sensors

### Safety information

#### **WARNING**

The vehicle radar sensors, and thus the driver assistance systems, can be negatively affected by external influences, e.g., interference. There is a risk of accident, injury, and property damage. Watch the surrounding traffic situation closely, be ready to take over steering and braking at any time, and actively intervene where appropriate.

## Front radar sensor

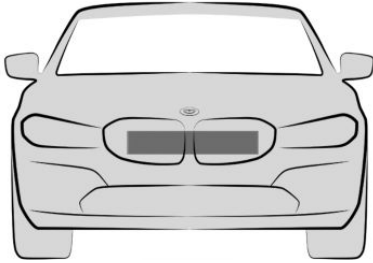

The front radar sensor is located in the radiator grille.

## Radar sensors, side, front

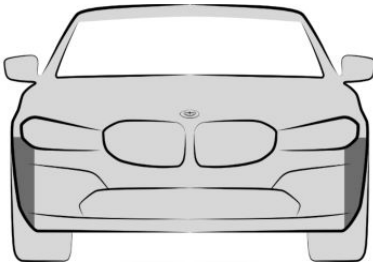

The radar sensors are located on the side of the front bumper.

## Radar sensors, side, rear

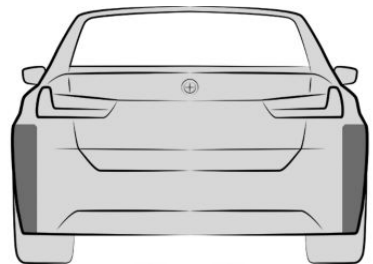

The radar sensors are located on the side of the rear bumper.

## Functional requirements of radar sensors

For the radar sensors to function correctly, the area around the radar sensors must be kept clean and free.

Additional information:

- ▶ Washing the vehicle, refer to page 371.
- ▶ Vehicle care, refer to page 373.

## System limits of the radar sensors

The function of the radar sensors may be restricted or not available, for instance in the following situations:

- ▶ In case of dirty sensors.
- ▶ In case of iced-up sensors.
- ▶ If sensors are covered such as by labels, films or a license-plate carrier.
- ▶ If the sensor is not aligned correctly, for instance due to parking damage.
- ▶ If the radiation range of the sensors is covered, e.g., by protruding cargo.
- ▶ When the field of view of the sensors is covered, e.g., by garage walls, hedges, snow hills, vehicles or trailers.
- ▶ After improper paint work on the vehicle in the area of the sensors.
- ▶ On steep hilltops or in sharp dips in the road.

If applicable, a Check Control message will be displayed when the system limits are reached.

## Ultrasonic sensors

### Ultrasonic sensors, front

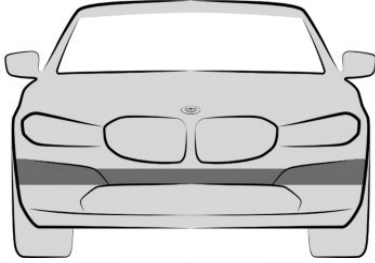

The ultrasonic sensors are located in the front bumper.

### Ultrasonic sensors, rear

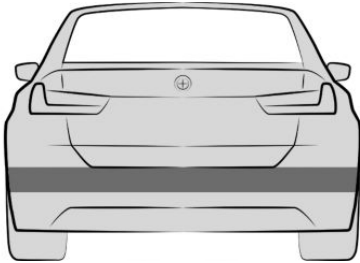

The ultrasonic sensors are located in the rear bumper.

### Ultrasonic sensors, side

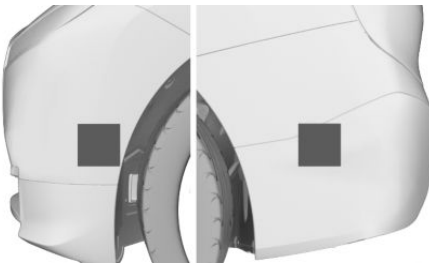

The ultrasonic sensors are located on the sides of the front and rear bumpers.

## Functional requirements of ultrasonic sensors

For the ultrasonic sensors to function correctly, the area around the ultrasonic sensors must be kept clean and free.

Additional information:

- ▷ Washing the vehicle, refer to page [371](#).
- ▷ Vehicle care, refer to page [373](#).

## System limits of the ultrasonic sensors

The detection of objects with ultrasonic measurements can run into physical limits, e.g., in the following situations:

- ▷ If the sensors are dirty or covered, e.g., by stickers.
- ▷ If the sensor is not aligned correctly, for instance due to parking damage.
- ▷ After improper paint work on the vehicle in the area of the sensors.
- ▷ For small children and animals.
- ▷ For people with specific clothing, e.g., coat.
- ▷ With obstacles and persons at the edge of the lane.
- ▷ In case of external interference with the ultrasonics, for instance from passing vehicles, loud machines or other ultrasonic sources.
- ▷ Under certain weather conditions, e.g., high moisture, wet conditions, snowfall, cold, extreme heat, or strong wind.
- ▷ With tow bars and trailer hitches of other vehicles.
- ▷ With thin or wedge-shaped objects.
- ▷ With moving objects.
- ▷ For elevated, protruding objects, e.g., wall ledges.
- ▷ With objects with corners, edges, and smooth surfaces.



- ▷ In the case objects with fine surfaces or structures, e.g., wire mesh fences.
- ▷ For objects with porous surfaces.
- ▷ With small and low objects, e.g., boxes.
- ▷ Low objects already displayed, for instance curbs, can be outside of the detection ranges of the sensors.
- ▷ With soft obstacles or obstacles covered in foam material.
- ▷ With plants and bushes.
- ▷ In automatic car washes.
- ▷ For bumps, e.g., speed bumps.
- ▷ If there are large amounts of exhaust gas.
- ▷ Cargo is protruding beyond the vehicle.

If applicable, a Check Control message will be displayed when the system limits are reached.

# Operating state of the vehicle

## Vehicle features and options

This chapter describes model-specific equipment, systems, and functions that are currently available, or may become available in the future, even if they are not present in the vehicle.

Additional information:

Vehicle equipment, refer to page 8.

## Principle



Depending on the situation, the vehicle will be in one of three operating states:

- ▶ Idle state, refer to page 39.
- ▶ Standby state, refer to page 41.
- ▶ Drive-ready state, refer to page 41.

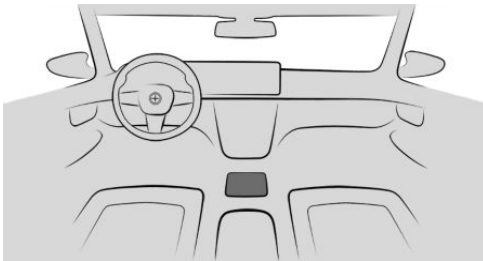
## Overview



The operating elements for manually setting the operating state are located at the bottom of the center console.

Operating element	Function
	Start/Stop button for turning on standby state or drive-ready state.
	Volume button for activating sleep mode or turning on standby state.

## Idle state

### Principle

When the vehicle is in idle state, it is switched off.

The vehicle is in idle state until it is opened from the outside or after it is exited and locked.

## Safety information

### **WARNING**

An unsecured vehicle can begin to move and possibly roll away. There is a risk of accident, injury, and property damage. Before leaving the vehicle, secure the vehicle against rolling away.

In order to ensure that the vehicle is secured against rolling away, follow the following:

- ▶ Set the parking brake.
- ▶ Make sure that selector lever position P is engaged.

- ▷ On uphill grades or on downhill slopes, turn the front wheels in the direction of the curb.
- ▷ On uphill grades or on downhill slopes, also secure the vehicle, for instance with a wheel chock.

### **⚠ WARNING**

Unattended children or animals in the vehicle can cause the vehicle to move and endanger themselves and traffic, for example, due to the following actions:

- ▷ Establishing standby.
- ▷ Releasing the parking brake.
- ▷ Opening and closing the doors or windows.
- ▷ Engaging selector lever position N.
- ▷ Using vehicle equipment.

There is a risk of accident, injury, and property damage. Do not leave children or animals unattended in the vehicle. Take the vehicle key with you when exiting and lock the vehicle.

## Establishing the sleep mode automatically

The vehicle switches automatically to idle state in situations like the following:

- ▷ After several minutes, if no operation takes place on the vehicle.
- ▷ If the charge state of the vehicle battery is low.
- ▷ Depending on the settings configured via iDrive, when one or both front doors are opened when exiting the vehicle after a drive.

In some situations, the idle state is not set automatically, for instance during a phone call or when the low-beam headlights are switched on.

## Establishing idle state when opening the front doors

After a trip, the sleep mode can be established by opening the front doors. All occupants must exit the vehicle.

To activate/deactivate this function, go through the menu as follows: Apps menu / "Vehicle" / "Doors and windows" / "Lock/unlock" / "Turn off after opening door".

## Establishing the sleep mode manually



To turn on sleep mode manually, push and hold the volume button on the center console until all displays go out.

## Deep sleep mode

### Principle

Deep sleep mode is activated to prevent the vehicle battery from discharging when the vehicle is stationary for several weeks.

In deep sleep mode, the vehicle functions are limited to the essentials.

Use deep sleep mode for long stationary periods.

When the vehicle is shut down for longer than three months, some special measures are necessary. For more information, contact an authorized service center or another qualified service center or repair shop.

### Activating/deactivating deep sleep mode

1. To enable deep sleep mode, go through the menu as follows: Apps menu / "Vehicle" / "System settings" / "Deep sleep mode".
2. Select the desired setting.

Deep sleep mode deactivates automatically when drive-ready state is turned on.

## Access to the vehicle

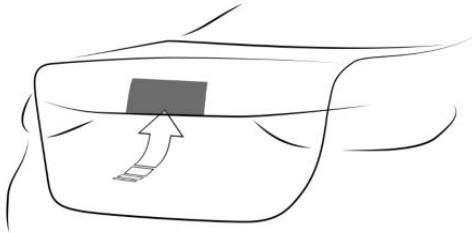

Press the button on the cargo area to access the vehicle while in deep sleep mode. Deep sleep mode remains on in this case.

## Standby state

### Principle

If standby state is activated, most functions can be used while the vehicle is stationary. Desired settings can be adjusted.

The vehicle is in standby state after the front doors are opened from the outside.

### Turning on standby state manually

#### General information

Standby state can be reactivated manually if the vehicle has been set to idle state automatically.

#### Via the volume button



To manually turn on standby state again using the volume button on the center console, push the volume button. The control display and the instrument cluster illuminate.

## Using the Start/Stop button



To manually turn on standby state again with the Start/Stop button, push the Start/Stop button on the center console. The control display and the instrument cluster illuminate.

## Display in the instrument cluster



If OFF is displayed on the instrument cluster, drive-ready state is turned off and standby state is turned on.

## Drive-ready state

### Principle

Turning on drive-ready state corresponds to starting the engine.

Some vehicle functions can only be used with the drive-ready state switched on.

## Safety information

### DANGER

If the exhaust pipe is blocked or ventilation is insufficient, harmful exhaust gases can penetrate the vehicle. The exhaust gases contain pollutants which are colorless and odorless. In enclosed areas, exhaust gases can also accumulate outside of the vehicle. There is a danger to life. Keep the exhaust pipe free and ensure sufficient ventilation.

### WARNING

An unsecured vehicle can begin to move and possibly roll away. There is a risk of accident, injury, and property damage. Before leaving the vehicle, secure the vehicle against rolling away.

In order to ensure that the vehicle is secured against rolling away, follow the following:

- ▷ Set the parking brake.
- ▷ Make sure that selector lever position P is engaged.
- ▷ On uphill grades or on downhill slopes, turn the front wheels in the direction of the curb.
- ▷ On uphill grades or on downhill slopes, also secure the vehicle, for instance with a wheel chock.

### NOTICE

Repeatedly attempting to start the engine or repeatedly starting the vehicle in rapid succession can cause the starter to overheat. This also results in unburned or inadequately burned fuel, and can cause the catalytic converter to overheat. There is a risk of property damage. Avoid repeated starting of the vehicle, particularly repeated starting in rapid succession.

## Turning on the drive-ready state

To turn on drive-ready state, proceed as follows:

1. Depress the brake pedal.
2. On the center console, press the Start/Stop button.

Most of the indicator lights and warning lights on the instrument cluster illuminate for different lengths of time.

Drive-ready state is switched on.

The engine will start automatically for a brief time until the engine is started.

## Gasoline engine

The full drive power may not be available after the gasoline engine is started. This can take up to 30 seconds, depending on the engine.

In this case, the vehicle will not accelerate as usual.

Additional information:

Power gauge, refer to page [142](#).

## Display in the instrument cluster

The activated drive-ready state is indicated in the instrument cluster, depending on the equipment, by the display of information required for driving or the READY display.

## Turning off drive-ready state

To turn off drive-ready state, proceed as follows:

1. While the vehicle is stationary, depress the brake and apply the parking brake.
2. On the center console, press the Start/Stop button.

The READY indicator goes out and a signal tone sounds.

The engine is shut off and the vehicle switches to standby.

The drive-ready state is switched off automatically if the driver's seat belt is not buckled when the driver's door is opened.

Depending on vehicle settings, the parking brake engages automatically when drive-ready state is turned off.

Additional information:

Parking brake, refer to page [127](#).

# BMW iDrive

## Vehicle features and options

This chapter describes model-specific equipment, systems, and functions that are currently available, or may become available in the future, even if they are not present in the vehicle.

Additional information:

Vehicle equipment, refer to page 8.

## Display and operating concept

### Principle

BMW iDrive is the vehicle's display and operating concept and includes a wide range of functions. Using BMW iDrive, for example, letters and numbers can be entered when setting a destination, and functions can be activated or deactivated.

Depending on vehicle equipment, the functions can be operated as follows:

- ▶ Via the control display.
- ▶ Via the BMW Intelligent Personal Assistant.
- ▶ Using the operating elements in the vehicle.

Additional information:

Instrument cluster, refer to page 44.

### Safety information

#### **WARNING**

Operating the integrated information systems and communication devices while driving can distract from surrounding traffic. It is possible to lose control of the vehicle. There is a risk of accident, injury, and property damage. Only use the systems or devices when the traffic situation allows. As warranted, stop and use





the systems and devices while the vehicle is stationary.

## Input and display

### Entering letters and numbers

Letters and numbers can be entered, e.g., when inputting destinations.

Letters and numbers can be entered using the control display or voice control.





Icon	Function
	Change between capital and lower-case letters.
	Enter a blank space.
<b>EN</b>	Switching between languages.
<b>OK</b>	Confirm entry.
	Tap icon: delete a letter or number.
	Press and hold the icon: delete all letters or numbers.

### Entry comparison

When entering data from a database such as contacts, the selection is gradually narrowed down for each character entered, with characters being added as necessary.

### Activating/deactivating the functions

Some menu items are preceded by an icon. To activate or deactivate the function, select the menu item.

Icon	Meaning
 	Function is activated.
 	Function is deactivated.
	Functions can be activated or deactivated using the button on the control display. If the button is highlighted in color, the function is activated.

## BMW Curved Display

### Principle

The BMW Curved Display is a single-screen display in the instrument panel that is curved towards the driver. The BMW Curved Display comprises the instrument cluster on the driver's side and the control display.

Follow the instructions for cleaning the BMW Curved Display in the Care chapter.

Additional information:

Caring for special components, refer to page 374.

### Overview

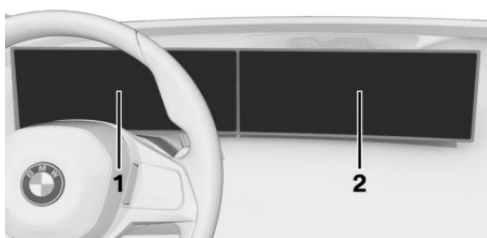

1 Instrument cluster 44

2 Control display 46

## Instrument cluster

### Principle

The instrument cluster comprises various digital displays, e.g., a speedometer, time, range, temperature as well as indicator and warning lights.

The buttons on the steering wheel can be used to configure the layout of the instrument cluster and the contents of the central display area, e.g., trip data. Additional views can be set on the control display, e.g., a second actual speed.

### Safety information

#### WARNING

If the driving information displays on the instrument cluster fail, e.g., the speedometer, do not use the vehicle. There is a risk of accident, injury, and property damage. Immediately park the vehicle in a safe manner. Turning drive-ready state off and on again may correct the malfunction, allowing you to continue driving. If the malfunction cannot be corrected, have the vehicle checked by an authorized service center or another qualified service center or repair shop.

### Overview

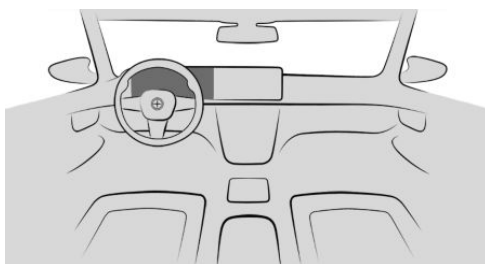

The instrument cluster is located behind the steering wheel.

## Display ranges on the instrument cluster

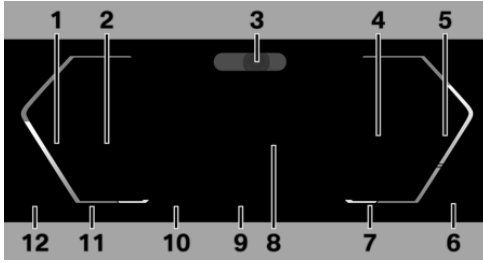

- 1 Speedometer
- 2 Driver assistance systems [213](#)  
Parking assistance systems [239](#)
- 3 Driver Attention Camera [206](#)
- 4 Check Control [134](#)  
Selector lever display [120](#)  
Gear shift indicator [141](#)  
Selection lists [141](#)  
Efficiency trainer [310](#)
- 5 Power gauge [142](#)  
Tachometer [143](#)
- 6 Engine temperature [144](#)
- 7 Outside temperature [145](#)
- 8 Central display range [145](#)  
Shift lights [145](#)
- 9 My Modes drive mode [126](#)
- 10 Speed Limit Info [213](#)  
Speed Limit Assistant [234](#)
- 11 Time [148](#)
- 12 Fuel gauge [143](#)  
Range [143](#)

The positions of some displays may vary, e.g., the selector lever display.

Some of the displays in the instrument cluster may differ from the illustrations in the Owner's Manual.

Additional information:

Indicator lights and warning lights, refer to page [135](#).

## Operating elements on the steering wheel

### Operating element Function



Display the menu bar on the instrument cluster.



Turn thumbwheel: scroll selection up or down.

Tilt thumbwheel in corresponding direction: Move selection to left or right.

Press thumbwheel: confirm selection.

## Configuring the layout

The layout of the instrument cluster adapts to the respective driving mode.



1.  Press the Settings button on the steering wheel.  
A menu bar is displayed in the instrument cluster.
2. "LAYOUT"
- Select the menu by tilting the thumbwheel on the steering wheel where applicable.
3. Select the desired setting using the thumbwheel on the steering wheel.

## Settings

Specific displays can be configured individually, e.g., a second actual speed.

1. Go through the menu as follows: Apps menu / "Vehicle" / "Displays" / "Instrument cluster".
2. Select the desired setting.

## Control display

### Principle

The iDrive functions are displayed on the control display.

The control display switches on automatically when it is needed for operation or when the vehicle is unlocked.

The control display can also be turned on/off manually.

The main menu of BMW iDrive is divided into different areas, e.g., menu bar, status information, and widgets.

You can configure various settings such as the brightness of the control display.

### Safety information

#### WARNING

When driving, loose items or devices connected to the vehicle with a cable, i.e., mobile phones, may be thrown around the vehicle, e.g., in the event of an accident or when braking or performing evasive maneuvers. There is a risk of injury and risk of property damage. Secure loose objects or devices that are connected to the vehicle via a cable.

#### WARNING

Objects in the area in front of a display can slip and damage the display. There is a risk of injury and risk of property damage. Do not place objects in the area in front of a display.



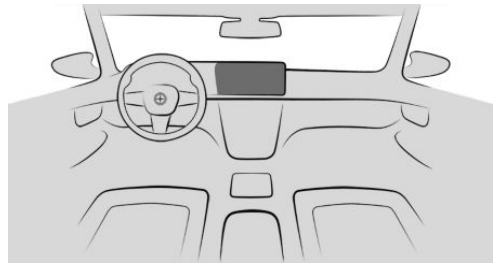

### Overview



The control display is located on the instrument panel above the center console.

### Buttons on the control display

When operating the control display, the buttons on the control display illuminate.

Button	Function
	Go to the previous menu.
	Go to the Media menu.
	Bring up the Communication menu.
	Go to Navigation menu.

### Turning the control display on/off

The control display is turned on automatically when the vehicle is unlocked or as soon as the control display is needed for operation.

In certain situations, the control display is switched off automatically, for instance if no operation is performed on the vehicle for several minutes.

The control display can also be switched off manually.

1. Swipe from top to bottom on the control display.
2. "Control display off"

Tap the control display to turn it on again.

## Main menu

### General information

The main menu on the control display is divided into different areas.

### Overview



- 1 Widgets
- 2 Status information
- 3 Temperature setting
- 4 Menu bar

### Menu bar

#### General information

The menu bar may not be displayed when using third-party apps. To display the menu bar again, swipe up from the lower edge of the control display or press a button.

#### Main menu

 The main menu can be opened from any menu.

### Climate menu

 The Climate menu provides access to all climate control functions.

### Apps menu

 The Apps menu provides access to all apps and vehicle functions. You can use a filter to make it easier to find a specific app. The last selected filter is stored. To display the desired app, change the filter as necessary.

### Apple CarPlay®

 The Apple CarPlay menu is displayed in the main menu depending on national-market version and connected function. Apple CarPlay enables the secure use of certain functions of a compatible Apple iPhone via iDrive.

### Android Auto®

 The Android Auto menu is displayed in the main menu, depending on national-market version and associated function. Android Auto enables the secure use of certain functions of a compatible Android smartphone via iDrive.

### Widgets





The widgets provide real-time information and dynamic content, e.g., the navigation map. Widgets also serve as buttons and allow you to jump to the respective menu or most important functions.

### Status information









#### General information

Status information is displayed at the top of the control display in the form of icons. Depending on the equipment and national-market version, different icons are available.





## Telephone status information

Icon	Meaning
	Active call.
	Signal strength.
	SIM card not active or not registered.
	Wireless charging active.

## Entertainment status information

Icon	Meaning
	Bluetooth audio.
	Smartphone audio.
	Connected Music with Spotify.
	Time shift.
	Wi-Fi.
	Apple CarPlay.
	Android Auto.
	Satellite tuner is on.







## Status information messages

Icon	Meaning
	Number of notifications.
	Check Control message.
	Do not disturb.
	Message.

Additional information:

Owner's Manual for Navigation, Entertainment, and Communication, refer to page 6.

## Other status information

Icon	Meaning
	Sound output active.
	Sound output deactivated.
	Activation word active.
	BMW ID or driver profile.
	Destination guidance active.
	Go to quick access.
	Park Distance Control: sound deactivated.

## Quick access

Certain functions and individual shortcuts can be opened via quick access.

Function	Operation
Show quick link.	Swipe from top to bottom on the control display. — Tap the icon at the top of the screen.
Hide quick link.	Swipe from the bottom up on the control display.

## Shortcuts

## Principle

Shortcuts provide quick access to functions such as those that are frequently used. Shortcuts are opened via the quick link and can be defined individually. The following functions, for example, are defined as shortcuts:

- ▶ The radio stations.
- ▶ The navigation destinations.
- ▶ The phone numbers.
- ▶ The jump-ins to menus.
- ▶ The functions.

Shortcuts can only be created with an active BMW ID or a driver profile.

## Saving shortcuts

1. To save shortcuts, press and hold the desired function.
2. "Add to shortcuts"

Shortcuts can also be saved directly via the quick link.

## Selecting shortcuts

1. To select shortcuts, swipe from top to bottom on the control display.
2. Select the desired shortcut.

This is done immediately, e.g., the connection is established as soon as a phone number is selected.

## Sorting shortcuts

1. To sort shortcuts, swipe from top to bottom on the control display.
2. Press and hold the desired shortcut and move it to the desired position.

## Deleting shortcuts

1. To delete shortcuts, swipe from top to bottom on the control display.
2. Press and hold the desired shortcut.
3.  Tap the delete icon for the desired shortcut.

## Settings

### Setting the brightness

1. To adjust the brightness of the control display, go through the menu as follows: Apps menu / "Vehicle" / "Displays" / "Cockpit brightness" / "Control display brightness at night".
2. Select the desired setting.

Depending on the light conditions, the brightness control may not be clearly visible.

## Enabling/disabling audible feedback

1. To enable/disable audio confirmation for the control display, go through the menu as follows: Apps menu / "Sound" / "Touchscreen".
2. Select the desired setting.

## System limits

In the case of very high temperatures on the control display, for instance due to intense solar radiation, the brightness may be reduced down to complete deactivation. Once the temperature is reduced, for instance through shade or air conditioning, the normal functions are restored.

## Operation via control display

### Principle

The control display is equipped with a touchscreen.

You can tap on menu items and widgets. Touch the control display with your fingers, do not use any objects.

### Sorting apps

1. To sort apps, bring up the Apps menu.
2. Press and hold the desired app icon and move it to the desired position.

### Calling up the context menu

Depending on the menu item, a context menu with additional options can be displayed.

To bring up the Context menu, press and hold the desired menu item.

The menu consists of various areas, for instance:

- ▶ "General help": the Integrated Owner's Manual opens.
- ▶ "Add to shortcuts": the menu item is defined as a shortcut.

## Using the map

The navigation map can be moved on the control display.

Function	Operation
Move map.	Swipe in the appropriate direction.
Enlarge/shrink map.	Drag in or out with the fingers.
Display menu.	Tap once.

## Using alphabetical lists

Contacts are listed in alphabetical order.

To navigate to a desired initial letter in a list of more than 30 entries, select the letter on the letter bar and scroll up or down.

Favorites are displayed at the top of the list.

Entries with numbers are displayed at the end of the list.

## Direct access buttons

### Principle

There are buttons for jumping directly to certain functions in the vehicle. These buttons can be used to bring up the respective menu directly on the control display. Then continue operation via iDrive.

### Overview

The direct jump buttons are located on the center console, turn signal lever, and headliner.

### Button Function



Go to the Drive Settings menu on the center console.



Go to the Exterior Lighting menu on the turn signal lever.



Go to the Interior Lighting menu on the headliner.

## BMW Intelligent Personal Assistant

### Principle

The BMW Intelligent Personal Assistant is a personal assistant that enables natural voice operation of various vehicle functions.

The Personal Assistant provides proactive suggestions to make it easier to operate the vehicle. The Personal Assistant is available depending on national-market version. The function scope and detection may vary depending on national-market version.

You can use supported voice assistants from third parties in your vehicle after pairing your smartphone.

You can configure various settings such as the suggestions from the Personal Assistant.

The system includes special microphones on the driver side and the front passenger side.

### Using the voice activation system

>...<: In the Owner's Manual, commands that can be spoken are indicated by brackets.

When saying commands, note the following:

- ▶ Say the commands at a normal volume. Speaking directly into the microphone does not improve voice recognition.
- ▶ Say the commands smoothly and with normal intonation and speed.

## Functional requirements

To use the Personal Assistant, the following functional requirements must be met:

- ▶ A language that is supported by the Personal Assistant must be set via iDrive.
- ▶ Download the corresponding language package before using the Personal Assistant for the first time.
- ▶ Commands must always be spoken in the selected system language.

For the full range of functions, you must activate or purchase the following functions:

- ▶ Online speech processing is enabled.
- ▶ All settings under Data privacy are enabled.
- ▶ The activation word is enabled.
- ▶ Suggestions are activated.
- ▶ A BMW ID or driver profile is activated.
- ▶ Corresponding ConnectedDrive services are purchased in the ConnectedDrive Store.
- ▶ The BMW Digital Premium subscription has been purchased.

Additional information:

- ▶ Setting the system language, refer to page [52](#).
- ▶ Online speech processing, refer to page [53](#).
- ▶ Data protection, refer to page [60](#).
- ▶ Activation word, refer to page [51](#).
- ▶ Get suggestions, refer to page [53](#).

## Activating the voice control system

### General information

You can activate voice control as follows:

- ▶  Press the microphone button on the steering wheel.
- ▶ Say the activation word.

## Microphone button on steering wheel

1.  To activate voice control with the microphone button, press the voice control button on the steering wheel.  
The microphone on the driver's side is active.
2. Say the desired command.

## Activation word

### Principle

Saying the activation word will start the Personal Assistant: ›Hello BMW‹. The microphones on the driver's or front passenger's side remain on during the subsequent voice dialog, depending on where the activation word was spoken.

Then say the command. The activation word and the command can be spoken without pause in one sentence.

### Enabling/disabling the activation word

The activation word can be enabled and disabled.

Go through the menu as follows: Apps menu / "All" / "Personal Assistant" / "Settings" / "General" / "Activation with voice control".

### Activation word from third-party providers

Depending on the national-market version, some third-party providers provide digital voice assistants such as Siri or Amazon Alexa.

To use Siri, the smartphone must be connected via Apple CarPlay.

Supported voice assistants can be used in the vehicle after you have connected your smartphone.

The activation word for voice assistants from associated third-party providers can be used

in addition to your preset activation word from BMW.

1. Go through the menu as follows: Apps menu / "Vehicle" / "System settings" / "Voice control" / "Other assistants".
2. Select the desired setting.

## Canceling voice control

You can cancel voice control as follows:

- ▶  Press the voice control button on the steering wheel again.
- ▶ Say the following command: >Cancel<

## Possible voice commands

### Principle

Voice commands can be used to give instructions or ask questions, with the Personal Assistant providing assistance.

The following can be done by voice control, for example:

- ▶ Calling contacts.
- ▶ Navigating to an address.
- ▶ Adjust the settings.
- ▶ Operating vehicle functions, e.g., climate control.

You can reach most content on the control display, e.g., menu items or lists, using spoken commands.

### Help for voice control

You can say the following commands to get help with voice control:

- ▶ >Voice commands<: possible commands are announced.
- ▶ >General information on voice control<: information on how voice control works is announced.
- ▶ >Help<: tips and example commands for voice control are announced.

## Sample commands

The following voice commands serve as examples.

- ▶ >Call John Smith<
- ▶ >Drive me to JFK airport<
- ▶ >Increase volume< or >Decrease volume<
- ▶ >Activate the climate control<
- ▶ >What is my remaining range<
- ▶ >Sport mode<

Additional example commands can be displayed on the control display.

Go through the menu as follows: Apps menu / "Vehicle" / "Personal Assistant" / "Example commands".

Sample commands are displayed in the BMW Intelligent Personal Assistant widget.

### Menu items

The Personal Assistant can open menu items directly. Say the menu items as they are displayed on the control display. You do not have to follow the order of the menu items when speaking them out loud.

## Settings

### Setting the system language

The system language set must be supported by the Personal Assistant. A language package can be downloaded.

1. Go through the menu as follows: Apps menu / "Vehicle" / "System settings" / "Language".
2. Select the desired setting.

### Managing language packages

1. To manage language packages, go through the menu as follows: Apps menu / "All" / "Personal Assistant" / "Settings" / "General" / "Language".
2. Select the desired language package.

## Suggestions

The Personal Assistant provides helpful, individual suggestions. Suggestions can be enabled or disabled. Suggestions can be customized, e.g., which categories suggestions are based on or whether to emit a signal tone.

1. To configure the settings, go through the menu as follows: Apps menu / "All" / "Personal Assistant" / "Settings" / "Suggestions".
2. Select the desired setting.

## Online speech processing

Online speech processing improves the quality of the speech recognition and search results for points of interest. To use the functions, data is transmitted to a service provider via an encrypted connection and stored locally there. Online speech processing is not available in all languages. Online voice processing can be deactivated depending on national-market version.

Go through the menu as follows: Apps menu / "All" / "Personal Assistant" / "Settings" / "General" / "Online speech processing".

## Configuring the visualization

1. To adjust the visualization of the Personal Assistant, go through the menu as follows: Apps menu / "All" / "Personal Assistant" / "Settings" / "General" / "Visualization".
2. Select the desired setting.

## Voice control from third-party providers

Depending on vehicle equipment, third-party voice control can be activated by pressing and holding the microphone button on the steering wheel.

1. Go through the menu as follows: Apps menu / "Vehicle" / "System settings" / "Voice control".
2. Select the desired setting.

## Adjusting the volume

Turn the volume button during the voice guidance until the desired volume is set.

The volume remains constant even if the volume of other audio sources is changed.

## Using the smartphone's voice control

Depending on the device, a smartphone connected to the vehicle can be used via voice control.

The device must be connected via Apple CarPlay or Android Auto.



1. Press and hold the voice control button on the steering wheel for approx. 3 seconds.

The smartphone's voice control is enabled.

If activation is successful, a confirmation appears on the control display.



2. Press the voice control button on the steering wheel in order to cancel the smartphone's voice control.

## Amazon Alexa Car Integration

### Principle

Amazon Alexa Car Integration is available depending on vehicle equipment and national-market version. Alexa is a digital assistant from Amazon. With Amazon Alexa Car Integration, Alexa can be used in the vehicle. For safety reasons, the use of some Alexa functions may be restricted while driving your vehicle.

### Functional requirements

To use Amazon Alexa Car Integration, the following functional requirements must be met:

- ▷ A BMW ID or driver profile is activated.
- ▷ An active Amazon account must exist.

## Activating Amazon Alexa Car Integration

Amazon Alexa Car Integration is activated in the vehicle.

Follow the instructions from the Amazon Alexa app to set it up in the vehicle.

1. To activate Amazon Alexa Car Integration, go through the menu as follows: Apps menu / "All" / "Alexa".
2. Select the desired setting.

After setting it up, use Amazon Alexa in the vehicle as follows:

Say the activation word "Alexa" and the desired command.

Information about the active function is displayed on the control display.

## System limits

- ▷ The Personal Assistant provides information about vehicle functions that may not be installed in the vehicle. This also applies to safety functions and systems.
- ▷ Certain noises can be detected and may cause issues. Keep the doors and windows closed.
- ▷ Noises from the front passenger or occupants can impair the system. Avoid making other noise in the vehicle while speaking.
- ▷ The use of certain dialects may cause issues with speech recognition.
- ▷ A poor data connection affects the response time of the Personal Assistant and search function.

## Connecting mobile devices to the vehicle

### Principle

Mobile devices can be used in the vehicle for various functions. Pairing with the vehicle is beneficial when using mobile devices:

- ▷ Operating the mobile device via iDrive.
- ▷ Making calls via the hands-free system.
- ▷ Better connection to the telephone network and internet using the vehicle's cell phone antennas.
- ▷ Listen to music on the vehicle's sound system.
- ▷ Surf the internet via personal hotspot on the vehicle's integrated SIM card.
- ▷ Operating smartphone apps, e.g., Apple CarPlay or Android Auto.

### General information

Detailed information on the functions and connection modes is provided in the following media from the Owner's Manual under the specified keyword:

- ▷ Integrated Owner's Manual in the vehicle.
- ▷ Printed Owner's Manual for navigation, communication and entertainment.

The following information sources can also be used:

- ▷ Driver's Guide app.
- ▷ Driver's Guide Web.

### Safety information

#### WARNING

Operating the integrated information systems and communication devices while driving can distract from surrounding traffic. It is possible to lose control of the vehicle. There is a risk of accident, injury, and property damage. Only

use the systems or devices when the traffic situation allows. As warranted, stop and use the systems and devices while the vehicle is stationary.

# BMW Remote Software Upgrade

## Vehicle features and options

This chapter describes model-specific equipment, systems, and functions that are currently available, or may become available in the future, even if they are not present in the vehicle.

Additional information:

Vehicle equipment, refer to page [8](#).

## BMW Remote Software Upgrade

### Principle

Remote Software Upgrade can be used to update the entire software of the vehicle.

An update can include the following, for example:

- ▶ New functions.
- ▶ Functional enhancements.
- ▶ Quality improvements.

The vehicle manufacturer recommends performing the Remote Software Upgrade as soon as it becomes available.

After the vehicle software is updated, the Owner's Manual for the vehicle will contain the latest information. When a Software Update is offered in the vehicle, the contents of the BMW Driver's Guide app and the BMW Driver's Guide website are also updated.

The Remote Software Upgrade may not be available in some countries.

## Safety information

### WARNING

Unattended children or animals in the vehicle can cause the vehicle to move and endanger themselves and traffic, for example, due to the following actions:

- ▶ Establishing standby.
- ▶ Releasing the parking brake.
- ▶ Opening and closing the doors or windows.
- ▶ Engaging selector lever position N.
- ▶ Using vehicle equipment.

There is a risk of accident, injury, and property damage. Do not leave children or animals unattended in the vehicle. Take the vehicle key with you when exiting and lock the vehicle.

## Functional requirements

To install a Remote Software Upgrade, the following requirements must be met:

- ▶ Active ConnectedDrive contract.
- ▶ The integrated SIM card in the vehicle has been activated.
- ▶ The vehicle has mobile network reception.
- ▶ Consent to send corresponding data has been granted in the BMW Remote Software Upgrade settings.

## Settings

To bring up the Remote Software Upgrade settings, go through the menu as follows: Apps menu / "All" / "System settings" / "Remote Software Upgrade" / "Settings".

Additional information:

Data protection, refer to page [60](#).

## Search for an upgrade

### Functional requirements

Standby must be turned on to search for a Remote Software Upgrade.

### Automatic search

The vehicle checks regularly for Remote Software Upgrades in the background.

### Manual search

1. To search manually for a Remote Software Upgrade, go through the menu as follows: Apps menu / "All" / "System settings" / "Remote Software Upgrade" / "Search for upgrade".
2. Follow the instructions on the control display.

## Download of an upgrade

### Automatic download

If available, the data for a Remote Software Upgrade is automatically downloaded to the vehicle. No download consent is required.

### Via My BMW App

When a Remote Software Upgrade is available, the My BMW App will provide information on the new software version.

The data for the upgrade can then be downloaded onto a mobile device.

Data can then be sent from the mobile device to the vehicle.

This transmission method accelerates the download of the data, for instance in areas with limited mobile network availability.

You do not need to be present in the vehicle to download the data to a mobile device.

1. Download the upgrade using the My BMW App on your smartphone.
2. Follow the instructions in the My BMW App.

3. Connect your smartphone to the vehicle via Bluetooth audio and Wi-Fi.

Data for the upgrade is sent from the mobile device to the vehicle both while driving and when stopped. Depending on the size of the upgrade, it may be necessary to drive the vehicle to complete the data transfer.

4. Follow the instructions on the control display.

Additional information:

Connecting mobile devices to the vehicle, see Owner's Manual for Navigation, Entertainment, Communication.



## Information about the version

### Principle

The information about the version contains a description of the updates included in the Remote Software Upgrade. During the download and after the installation has been successfully completed, the information about the version can be displayed on the control display.

The version history can also be viewed on the BMW website. To do so, log in to the personal area using the BMW ID.

### Displaying information

1. To display the version history in the vehicle, go through the menu as follows: Apps menu / "All" / "System settings" / "Remote Software Upgrade".
2.  The currently installed version is displayed.
  -  Display new available version: "Version info"
3. Follow the instructions on the control display.

More information is provided on the corresponding BMW website.

## Installing the upgrade

### General information

Before installing an upgrade, note the following:

- ▶ Installation of the Remote Software Upgrade may result in the deletion of software changes, e.g., performance increases not made by the manufacturer of the vehicle.
- ▶ The installation may be interrupted if there are modifications to the vehicle's electrical system, e.g., to control units, which were not made by the vehicle manufacturer.
- ▶ The installation does not occur until the consent was given.
- ▶ The installation may take around 20 to 30 minutes.
- ▶ The installation cannot be terminated.
- ▶ The vehicle cannot be used during the installation.
- ▶ The vehicle can be exited during the installation.

### Functional requirements

To install an upgrade, the following functional requirements must be met:

- ▶ Sufficiently charged battery.
- ▶ The outside temperature is above 14°F/-10°C.
- ▶ The vehicle is parked in a horizontal position.
- ▶ The hazard warning system is turned off.
- ▶ The selector lever position P is engaged.
- ▶ The engine is turned off and sufficiently cooled down.

Pay attention to any instructions given on the control display regarding additional requirements.

Your vehicle can establish some prerequisites automatically.

If the requirements are not met, the upgrade will not be offered for installation.

If all prerequisites are met, you can also start the upgrade installation via the My BMW App. Follow instructions in the My BMW App.

Pay attention to an offer for installation, e.g., after longer trips.

### Preparing the vehicle

The vehicle must be prepared for the Remote Software Upgrade as follows:

- ▶ Park the vehicle safely away from the public road.
- ▶ Make sure that the vehicle has mobile network reception so that a fault message can be sent to the vehicle manufacturer, e.g., if the installation is canceled.
- ▶ Close the windows.
- ▶ Close the glass sunroof.
- ▶ Close the cargo area.
- ▶ Disconnect devices that consume power, e.g., mobile phones.
- ▶ The vehicle key must be located in the vehicle for the consent for installation.
- ▶ Turn off the exterior lighting.
- ▶ Remove any devices connected to the diagnostic socket.

### Install the upgrade immediately

The upgrade can be installed immediately if all prerequisites have been met.

1. Go through the menu as follows: Apps menu / "All" / "System settings" / "Remote Software Upgrade" / "Let's get started".
2. Follow the instructions on the control display.

### Installing an upgrade with the timer

Once the drive is complete, the timer can be used to automatically install the upgrade at a preset time, e.g., during the night. It may be

helpful to install the upgrade at a later time in order to meet functional requirements, e.g., to allow the engine to cool sufficiently.

1. Go through the menu as follows: Apps menu / "All" / "System settings" / "Remote Software Upgrade".
2. Select the desired settings.

Installation starts automatically at the specified time if:

- ▷ All prerequisites for the installation have been established correctly.
- ▷ All prerequisites continue to be met at the time of installation.

The timer is turned off when the drive-ready state is turned on.

### Installing via the My BMW App

Once all preparations are complete and all requirements are met, the upgrade installation can also be started using the My BMW App when the vehicle is parked. The upgrade installation can be started remotely. It is not necessary to be present in the vehicle.

It may be helpful to install the upgrade at a later time in order to meet functional requirements, e.g., to allow the engine to cool sufficiently.

Follow the instructions in the My BMW App.

### Functional limitations

During the upgrade, the majority of functions is temporarily unavailable, for instance:

- ▷ Hazard warning flashers.
- ▷ Central locking system and Comfort Access, as applicable.
- ▷ Parking light.
- ▷ Horn.
- ▷ Alarm system.
- ▷ Emergency call.
- ▷ Power windows.
- ▷ Glass sunroof.

- ▷ Locking the tank flap.
- ▷ Operating the tailgate or trunk lid.
- ▷ Exit Warning if needed.

In vehicles with frameless doors, the window may no longer close completely.

The driver's door can be locked and unlocked from the outside using the integrated key.

### After successful upgrade

The vehicle can be used again immediately.

Purchased services, e.g., Advanced Real Time Traffic Information or Remote Services, are automatically reactivated the next time the vehicle is driven.

If the vehicle has been stationary for some time, it may be necessary to recharge the vehicle battery by going for a long drive.

### Malfunction

If the Remote Software Upgrade system may not be operational, follow the instructions given on the control display or My BMW App.

If the malfunction cannot be corrected, contact an authorized service center or another qualified service center or repair shop.

### Validity of the Owner's Manual

#### Production of the vehicle

At the time of production at the plant, the printed Owner's Manual is the most current resource.

#### After a software update in the vehicle

After a vehicle software update, for example, via Remote Software Upgrade, the Integrated Owner's Manual for the vehicle will contain the latest information, depending on the national-market version.

Before setting off, make sure that the Integrated Owner's Manual is available and up-to-date.

# Personal settings

## Vehicle features and options

This chapter describes model-specific equipment, systems, and functions that are currently available, or may become available in the future, even if they are not present in the vehicle.

Additional information:

Vehicle equipment, refer to page 8.

## Data protection

### Data transfer

#### Principle

The vehicle offers different services, whose use requires a data transfer to BMW or a service provider.

The data transfer can be deactivated for some services. When data transfer is deactivated, the respective service cannot be used.

#### Settings

The data transfer can be configured in different stages or individually for separate services.

1. To configure the settings, go through the menu as follows: Apps menu / "All" / "Data privacy".
2. Select the desired setting.

### Personal data in the vehicle

#### Principle

Depending on use, your vehicle stores personal data such as saved radio stations. This personal data can be permanently deleted using iDrive.

### General information

Depending on vehicle equipment, the following data is deleted, for example:

- ▶ BMW IDs or driver profiles.
- ▶ Stored radio stations.
- ▶ Stored shortcuts.
- ▶ Navigation, for instance stored destinations.
- ▶ Phone book.
- ▶ Online data, e.g., favorites, cookies.
- ▶ Office data, for instance voice memos.
- ▶ Login accounts.
- ▶ Digital key.

Altogether, the deletion of the data can take up to 15 minutes. In addition, the vehicle is removed from the My BMW App and Connected-Drive customer portal so that remote functions can no longer be used.

### Functional requirements

To delete personal data in the vehicle, the following functional requirements must be met:

- ▶ Data can only be deleted while the vehicle is stationary.
- ▶ The vehicle key must be in the vehicle.

### Deleting personal data in the vehicle

The personal data in the vehicle will be deleted when the vehicle is reset to the factory settings.

Additional information:

Resetting vehicle data, refer to page 60.

## Reset vehicle data

All individual settings can be reset to the factory settings when the drive-ready state is

switched off. Individual settings can only be deleted while the vehicle is stationary. The vehicle key must be in the vehicle.

Go through the menu as follows: Apps menu / "Vehicle" / "System settings" / "Reset vehicle data" / "Reset vehicle data".

If setting synchronization has been activated for a BMW ID in the vehicle, personal settings are kept in the BMW Cloud.

## BMW ID

### Principle

In BMW ConnectedDrive countries, the BMW ID is the personal login for all relevant offers from the BMW brand. The BMW ID can be used to save personal vehicle settings to a profile as well as to apply these settings.

The vehicle can store seven BMW IDs. If a vehicle is used by several people, each person can use their own BMW ID in the vehicle. Additional profiles can be used to operate the vehicle without a BMW ID, e.g., the guest profile.

The BMW ID must be registered once. Registration can be completed on the My BMW App, in the ConnectedDrive customer portal, or at an authorized service center or another qualified service center or repair shop.

Automatic driver recognition can activate a BMW ID as soon as the vehicle is unlocked. A vehicle key or digital key must be linked to the BMW ID.

Many saved settings can be synchronized with the BMW Cloud. This makes these settings available in any vehicle where the same BMW ID is used to log in.

### Functional requirements

To use a BMW ID, the following functional requirements must be met:

- ▶ The vehicle must be stationary to create, change, delete, or edit a BMW ID.
- ▶ Logging in the vehicle with a BMW ID and synchronization with the BMW Cloud are only possible when the vehicle has cellular network reception.

### Welcome screen

The welcome screen appears on the control display after the vehicle is unlocked. The type of welcome depends on the following requirements:

- ▶ No BMW ID is saved to the vehicle:
 

The welcome is neutral. These profiles are provided to use the vehicle without a BMW ID. A new BMW ID can be added.
- ▶ The vehicle key or digital key has not been assigned to a BMW ID:
 

The welcome is neutral. Saved profiles are shown for selection. A new BMW ID can be added.
- ▶ A BMW ID has been assigned to the vehicle key or digital key:
 

The welcome is personalized. Saved settings are activated. Available profiles are shown for selection. A new BMW ID can be added.

### Adding the BMW ID

1.  To add a BMW ID, tap the BMW ID icon or profile picture on the status bar.
2. Depending on the profile, select one of the following menu options:
  - ▶ The guest profile is active: "Guest" / "Add profile".
  - ▶ The driver profile is active: "Log in with BMW ID".
3. Scan the displayed QR code with your smartphone.
4. Observe the instructions on your smartphone.

If the My BMW App is installed on the smartphone and the BMW ID saved to it, the BMW ID is automatically transferred to the vehicle.

If there is currently no BMW ID, a new BMW ID can be registered.

5. Change additional settings as necessary, e.g., automatic driver recognition.

The vehicle is added to the user's My BMW App.

Alternatively, the BMW ID can be registered and added to the vehicle by an authorized service center or another qualified service center or repair shop.

### Confirming a BMW ID

If the BMW ID was registered and added to the vehicle by an authorized service center or another qualified service center or repair shop, the BMW ID must be confirmed in the vehicle.

1.  To confirm a BMW ID, tap the BMW ID icon on the status bar.
2. Scan the QR code shown.
3. Follow the instructions on your smartphone.

It may be necessary to register the BMW ID again.

 This icon is displayed on the status bar and indicates when it is necessary to login again.

1. Select the BMW ID.
2. Scan the QR code shown.

Another registration will be attempted. Once successfully logged in, all functions can be used again.

### My BMW app

If a BMW ID has been added to a vehicle, the vehicle is automatically added to the My BMW app. The My BMW App provides numerous beneficial functions and settings, e.g., user management.

Alternatively, a vehicle can be added to the My BMW App by an authorized service center or another qualified service center or repair shop. In this case, the BMW ID must then be confirmed on the control display in the corresponding vehicle.

In rare cases, the use of My BMW app functions for this vehicle may be restricted. More information is shown on the control display.

### Primary user

The primary user is the person who first adds their BMW ID to the vehicle and first adds the vehicle to their My BMW App. Alternatively, the primary user can be specified by an authorized service center or another qualified service center or repair shop.

The primary user has access to the following settings, for example:

- ▶ Removing BMW IDs saved to the vehicle.
- ▶ Transferring the primary user role to another BMW ID.
- ▶ Configuring vehicle-wide data protection settings.
- ▶ Creating the main digital key.

Additional information:

BMW Digital Key, refer to page 73.

### Personalized settings

#### Automatic driver recognition

##### Principle

Automatic driver recognition can activate a BMW ID as soon as the vehicle is unlocked. For example, a BMW ID must be associated with a vehicle key or digital key. After unlocking, the BMW ID can be changed.

If driver recognition has been configured, automatic activation of the BMW ID is triggered by the following:

- ▷ By unlocking the vehicle using the button on the assigned vehicle key.
- ▷ By unlocking the vehicle using a door handle. The assigned vehicle key or the assigned digital key must be carried with you.
- ▷ By unlocking automatically when approaching the vehicle. The assigned vehicle key or the assigned digital key must be carried with you. Depending on the country, it may not be possible to recognize the digital key.

If multiple vehicle keys or digital keys are located near the vehicle, BMW IDs are activated according to the following priority:

- ▷ The key that triggers the door locks to release also activates the associated BMW ID.
- ▷ If a vehicle key and digital key are detected at the same time, the digital key triggers activation of the assigned BMW ID.
- ▷ The BMW ID of the key last detected on the driver's door is activated.

If the BMW ID could not be detected when the vehicle was unlocked, select the BMW ID on the welcome screen.

### Setting/adjusting automatic driver recognition

1.  To set or adjust automatic driver recognition, tap the BMW ID icon or profile image on the status bar.
2. "Profile settings"
3. "Driver recognition"
4. Select the desired setting.

### Transfer of the vehicle key

A vehicle key assigned to a BMW ID can be used to view or change the stored personal settings.

Before giving a vehicle key to another person, remove the associated driver detection as necessary.

The BMW Digital Key provides the option to transfer a digital key to permit other persons the use of your own vehicle.

Additional information:

BMW Digital Key, refer to page 73.

### Selecting a profile picture

The profile picture can be selected from the predefined profile pictures.

1.  To add a profile picture, tap the BMW ID icon or profile picture on the status bar.
2. Select the desired BMW ID.
3. "Profile settings"
4. "My BMW ID"
5. "Picture"
6. Select the desired profile picture.

The personal profile picture for a BMW ID can be adopted from the profile in the My BMW App. Synchronization with the BMW Cloud must be enabled in the settings in order to use the profile picture from the My BMW App. The default pictures can only be selected after deleting the profile picture on the My BMW App.

### Setting synchronization

#### Principle

If synchronization is on, settings from the following areas, for example, are synchronized:

- ▷ BMW ID, e.g., profile image.
- ▷ Navigation, e.g., recent destinations, home address, or map settings.
- ▷ iDrive, e.g., main menu configuration, language, or units.
- ▷ The Personal Assistant, e.g., suggestions or the activation word.
- ▷ Exterior lighting, e.g., one-touch signaling and pathway lighting.

Settings from the following areas are only synchronized when logging in for the first time:

- ▶ Seat and climate comfort functions, e.g., driver's seat position or temperature setting.
- ▶ Privacy menu.

### Turning synchronization on/off

1.  To enable/disable settings synchronization, tap the BMW ID icon or profile picture on the status bar.
2. "Profile settings"
3. "My BMW ID"
4. "Synchronize BMW ID"

In addition, the profile picture can be set if it has not been adopted from the My BMW App.

### Configuring PIN protection

Saved BMW IDs can be selected by every vehicle user. PIN protection can be configured in order to prevent the settings for a BMW ID from being changed or the data from being viewed.

1.  Tap the BMW ID icon or profile picture on the status bar.
2. Select the desired BMW ID.
3. "Profile settings"
4. "Lock screen"
5. Enter the desired PIN.

### Profile management



#### Editing profiles

The profile can be changed at any time.

1.  Tap the BMW ID icon or profile picture on the status bar.
2. "Change profile"
3. Select the desired BMW ID or profile.
4. If necessary, enter a PIN.

The BMW ID is activated and associated settings are loaded.

### Deleting a BMW ID

1.  To delete a BMW ID, tap the BMW ID icon or profile picture on the status bar.
2. "Profile settings"
3. "Manage profiles"
4.  Tap the delete icon for the desired BMW ID.

When deleting BMW IDs, note the following:

- ▶ Removing a BMW ID from the vehicle causes the vehicle to be removed from the My BMW App. If the BMW ID has been synchronized with the BMW Cloud, the data stored on the BMW Cloud is retained after the BMW ID is deleted. If the currently active BMW ID is removed, another profile must be selected.
- ▶ Deleting the primary user's BMW ID resets the vehicle to factory settings. The vehicle will be removed from each user's My BMW App. All BMW IDs are removed from the vehicle.
- ▶ Removing a vehicle from the My BMW App removes the corresponding BMW ID from the vehicle. If the BMW ID was synchronized with the BMW Cloud, the BMW ID data stored in the BMW Cloud will be retained.
- ▶ If the vehicle is removed from the primary user's My BMW App, it will also be removed from the other users' My BMW App. The corresponding BMW IDs are removed from the vehicle.

### Additional profiles

#### Principle

Additional profiles can be used to operate the vehicle without a BMW ID.

#### Driver profile

"Driver ": if no BMW ID is available, vehicle settings can be saved to this profile.

This profile is subject to the following restrictions, among others:

- ▶ Automatic driver detection cannot be associated with a user.
- ▶ The name and profile image cannot be changed.
- ▶ Synchronization with the BMW Cloud is not enabled.
- ▶ Certain functions are not available, e.g., individual navigation functions or saving favorites.

The profile, and the settings saved to it, can be transferred to a BMW ID. The BMW ID is then displayed instead of the profile.

### Guest profile

"Guest": this profile can be used to operate the vehicle without changing the settings saved for other profiles.

This profile is subject to the following restrictions, among others:

- ▶ Changed settings are not saved.
- ▶ Automatic driver detection and the PIN cannot be associated with a user.
- ▶ The name and profile image cannot be changed.
- ▶ Synchronization with the BMW Cloud is not enabled.
- ▶ Certain functions are not available, e.g., individual navigation functions or saving favorites.

### System limits

It may not be possible to clearly identify the driver using the vehicle key or digital key in the following situations, for example:

- ▶ The driver changes, but the vehicle is not locked and unlocked.
- ▶ If multiple vehicle keys or multiple digital keys linked to a BMW ID are located outside the vehicle on the driver's side.
- ▶ If the vehicle was unlocked using the My BMW App.

There are technical limitations to using the settings for a BMW ID in other vehicles. For example, settings may be stored for a system that is not available, or available in a non-compatible version, in other vehicles.

## Driver profiles

### Principle

Driver profiles can be used in countries where BMW ConnectedDrive is not available in order to save and activate personal vehicle settings in the vehicle.

Your vehicle can save up to seven driver profiles. If a vehicle is used by several people, each person can use their own driver profile in the vehicle. The guest driver profile can be used when driving the vehicle without a driver profile.

Automatic driver recognition can activate a driver profile as soon as the vehicle is unlocked. A vehicle key must be linked to the driver profile.

### Functional requirements

The vehicle must be stationary to create, change, delete, or edit a driver profile.

### Welcome screen

A welcome screen appears on the control display after the vehicle is unlocked. The type of the welcome depends on the following prerequisites:

- ▶ No driver profile is saved to the vehicle:  
The welcome is neutral. A new driver profile can be added.
- ▶ No driver profile has been linked to the vehicle key:

The welcome is neutral. Saved driver profiles are shown for selection. A new driver profile can be added.

- ▶ A driver profile has been assigned to the vehicle key:

The welcome is personalized, the stored settings are activated. The available driver profiles are shown for selection. A new driver profile can be added.

## Driver profile, driver

"Driver": a driver profile allows the driver to save individual vehicle settings as well as create a name for this profile and select a profile image.

## Driver profile, guest

"Guest": this driver profile can be used to operate the vehicle without changing the settings saved for other driver profiles.

This profile is subject to the following restrictions, among others:

- ▶ Changed settings are not saved.
- ▶ Automatic driver detection and the PIN cannot be associated with a user.
- ▶ The name and profile image cannot be changed.

## Adding a driver profile

1.  To add a driver profile, tap the driver profile icon or profile picture on the status bar.
2. "Add profile"
3. Change additional settings as necessary, e.g., automatic driver detection.

## Personalized settings

### Automatic driver recognition

#### Principle

Automatic driver recognition can activate a driver profile as soon as the vehicle is unlocked. A vehicle key must be linked to the driver profile. After unlocking, you can change the driver profile.

If driver recognition has been configured, automatic activation of the driver profile is triggered by the following:

- ▶ By unlocking the vehicle using the button on the assigned vehicle key.
- ▶ By unlocking the vehicle using a door handle. You must carry your assigned vehicle key with you.
- ▶ By unlocking automatically when approaching the vehicle. You must carry your assigned vehicle key with you.

If multiple vehicle keys are located near the vehicle, driver profiles are activated according to the following priority:

- ▶ The key that triggers the door locks to release also activates the assigned driver profile.
- ▶ The driver profile of the key last detected at the driver's door is activated.

If the driver profile could not be detected when the vehicle was unlocked, select the desired driver profile on the welcome screen.

#### Setting/adjusting automatic driver recognition

1.  To set or configure automatic driver detection, tap the driver profile icon or profile picture on the status bar.
2. "Profile settings"
3. "Driver recognition"
4. Select the desired setting.

## Transfer of the vehicle key

A vehicle key assigned to a driver profile can be used to view or change saved personal settings.

Before giving a vehicle key to another person, remove the associated driver detection as necessary.

You can configure driver recognition in the driver profile settings.

## Configuring PIN protection

Once saved, driver profiles can be selected by every user of the vehicle. PIN protection can be configured in order to prevent the settings for a driver profile from being changed or the data from being viewed.

1.  Tap the driver profile icon or profile picture on the status bar.
2. Select the desired driver profile.
3. "Profile settings"
4. "Lock screen"
5. Enter the desired PIN.

## Profile management

### Changing driver profiles

The driver profile can be changed at any time:

1.  Tap the driver profile icon or profile picture on the status bar.
2. "Change profile"
3. Select the desired driver profile.
4. If necessary, enter a PIN.

The driver profile is activated and associated settings are loaded.

### Deleting the driver profile

1.  To delete a driver profile, tap the driver profile icon or profile picture on the status bar.
2. "Profile settings"

3. "Manage profiles"

4.  Tap the icon to delete the desired driver profile.

## System limits

It may not be possible to clearly identify the driver using the vehicle key in the following situations, for example:

- ▶ The driver changes, but the vehicle is not locked and unlocked.
- ▶ If multiple vehicle keys linked to a driver profile are located outside the vehicle on the driver's side.

# Opening and closing

## Vehicle features and options

This chapter describes model-specific equipment, systems, and functions that are currently available, or may become available in the future, even if they are not present in the vehicle.

Additional information:

Vehicle equipment, refer to page 8.

## Vehicle key

### Principle

The vehicle comes with one or two vehicle keys, depending on vehicle equipment and national-market version.

Vehicle keys contain a replaceable battery as well as an integrated key.

BMW Digital Key come with a vehicle key.

If the vehicle key cannot be detected, drive-ready state cannot turn on via emergency detection of the vehicle key.

A BMW ID or a driver profile with personal settings can be assigned to a vehicle key.

Depending on the equipment and national-market version, various settings are possible for the button functions. To change the button settings, a BMW ID or driver profile must be assigned to the corresponding vehicle key.

To provide information on maintenance recommendations, the service data is stored in the vehicle key.

To prevent possible locking in of the vehicle key, take the vehicle key with you when exiting the vehicle.

## Safety information



### WARNING

The vehicle key has a button cell battery. Batteries or button cell batteries can be swallowed and lead to serious or fatal injuries within two hours, for example due to internal burns or chemical burns. There is a risk of injury and danger to life. Keep the vehicle key and batteries out of reach of children. Immediately seek medical help if there is any suspicion that a battery or button cell battery has been swallowed or is located in any part of the body.

## Overview



Buttons on the vehicle key.

Icon	Meaning
	Unlock the vehicle.
	Lock the vehicle.
	Pre-conditioning, refer to page 279.

**Icon** **Meaning**

Open the cargo area.



Panic mode.

Pathway lighting, refer to page [157](#).

## Additional vehicle keys

Additional vehicle keys are available from an authorized service center or another qualified service center or repair shop.

## Loss of vehicle keys

A lost vehicle key can be disabled and replaced by an authorized service center or another qualified service center or repair shop.

If the lost vehicle key has an assigned BMW ID or driver profile, the connection to this vehicle key must be deleted. A new vehicle key can then be assigned to the BMW ID or driver profile.

## Replacing the battery

** NOTICE**

Improper batteries in a battery-operated device can damage the device. There is a risk of property damage. Always replace the discharged battery with a battery with the same voltage, the same size and the same specification.

To replace the vehicle key battery, proceed as follows:

1. Press and hold the button, arrow 1. At the same time, push the cover to the front and remove it from the side, arrow 2.



2. Pull the battery housing off of the vehicle key from the side.



3. Remove the battery from the battery housing.



4. Insert a CR2032 3V battery with the positive terminal facing down.

5. Insert the battery housing into the vehicle key.



6. Insert the cover into the vehicle key.



Have old batteries disposed of by an authorized service center or another qualified service center or repair shop, or take them to a collection point.



Batteries contain harmful chemicals. Disposing of batteries with household waste is prohibited by law.

## Integrated key

### Principle

The integrated key is built into the vehicle key. If the electrical system malfunctions, the vehicle can be unlocked and locked manually using the integrated key.

Depending on the national-market version, the integrated key will fit in the glove compartment.

## Safety information

### WARNING

For some national-market versions, unlocking from the inside is only possible with particular knowledge.

There is a risk of injury and danger to life if people or animals remain in the vehicle for a long period of time and are exposed to extreme temperatures. Do not lock the vehicle from the outside when there are people or

animals in it. Do not leave babies, toddlers or animals alone in the vehicle.

## Removing the integrated key

To remove the integrated key, proceed as follows:

1. Press and hold the button, arrow 1. At the same time, push the cover to the front and remove it from the side, arrow 2.



2. Slide out the integrated key on the open side of the vehicle key.



3. Remove the integrated key from the vehicle key.

## Unlocking the vehicle manually

1. Pull and hold the driver's door handle outward with one hand.

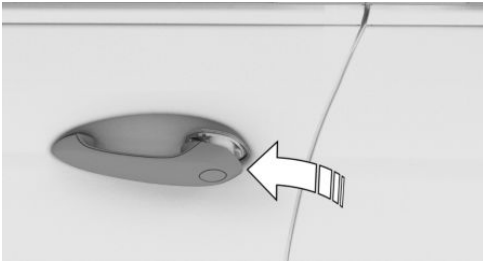

2. Guide one finger of your other hand from the back under the cover cap and push the cover cap out.

Use the thumb for counter support to prevent the cover cap from falling out of the door handle.



3. Remove the cover cap.
4. The position of the integrated key in the door lock depends on the vehicle.  
Unlock the door lock with the integrated key by turning it counterclockwise.

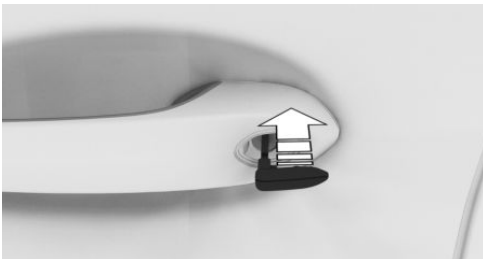

5. Open the driver's door.
6. Press the central locking button to unlock the other doors.  
With the vehicle de-energized: pull the door opener of the other doors from the inside.

## Locking the vehicle manually

### General information

To avoid locking the vehicle key in the vehicle, do not place the vehicle key in the vehicle.

### Overview

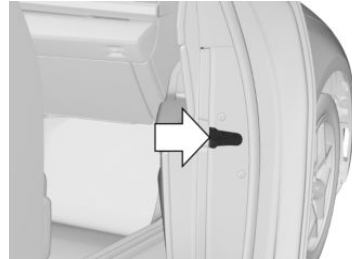

Side door lock for manually locking the doors.

### Locking the vehicle

To lock the vehicle, proceed as follows:

1. Close all doors.
2. Enter the vehicle on the front passenger's side and close the front passenger door.
3. Press the central locking button to unlock all doors.
4. Exit the vehicle through the front passenger door.
5. The position of the side key in the door lock depends on the vehicle.

With the integrated key, close and lock the front passenger door using the side door lock.

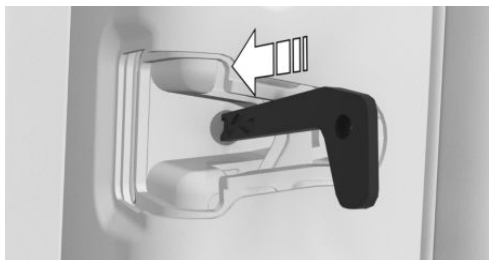

6. Pull the door handles to make sure they are locked. If necessary, repeat the process.

If vehicle is de-energized:

1. The position of the side key in the door lock depends on the vehicle.

With the integrated key, close and lock all doors, except the driver's door, using the side door lock.

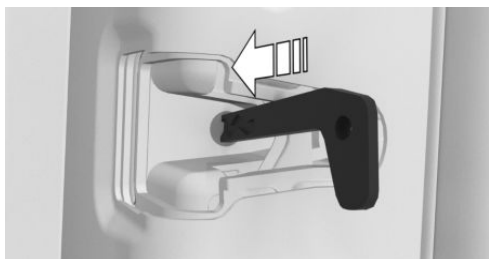

2. Close the driver's door.
3. The position of the integrated key in the door lock depends on the vehicle.

Using the integrated key, lock the driver's door lock clockwise.



4. Pull out the vehicle key and put on the cover cap.
5. Pull the door handles to make sure they are locked. If necessary, repeat the process.

### Alarm system

If the vehicle is unlocked with the integrated key via the door lock, the activated alarm system will be triggered when the door is opened.

In this case, use the vehicle key emergency detection to switch off the alarm.

If the doors are manually locked from the inside, the alarm system is not activated.

### Emergency detection of the vehicle key

#### Principle

If the vehicle key cannot be detected, drive-ready state cannot turn on via emergency detection of the vehicle key.

### Turning on the drive-ready state

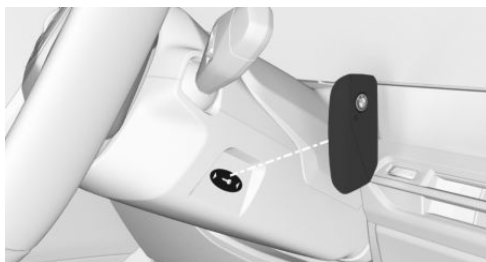

1. To turn on drive-ready state via emergency detection of the vehicle key, hold the back of the vehicle key to the marking on the steering column.
2. Pay attention to the information shown on the instrument cluster.
  - ▶ If the vehicle key is detected:  
Turn on drive-ready state within 10 seconds.
  - ▶ If the vehicle key is not detected:  
Change the position of the vehicle key slightly.

## Malfunction

A Check Control message is displayed where applicable.

Vehicle key detection by the vehicle may malfunction under the following circumstances:

- ▶ The battery of the vehicle key is discharged.
- ▶ The connection has been interrupted by a transmission tower or other device with a high transmitting power.
- ▶ The vehicle key is shielded by a building or metallic object.
- ▶ Connection interrupted by mobile phones or other electronic devices located directly next to the vehicle key.
- ▶ Wireless transmission interrupted by mobile device charging process, e.g., charging a mobile phone.
- ▶ The vehicle key is in direct proximity of the wireless charging tray.

In the case of interference, the vehicle can also be unlocked and locked from the outside with the integrated key. Use the Emergency detection of the vehicle key to turn on drive-ready state.

## BMW Digital Key

### Principle

BMW Digital Key lets you lock and unlock and start your vehicle using a digital key.

BMW Digital Key can be used with a compatible smartphone or another compatible device.

To unlock and start a vehicle with a compatible smartphone, this function must be offered by the smartphone manufacturer. The My BMW app can be used to check if the smartphone and vehicle are compatible and which functions are supported.

Each vehicle can be provided with a main digital key. Additional digital keys can be shared and then deleted.

### General information

BMW Digital Key availability and functionality depend on vehicle equipment and national-market version.

The Setup Card and Service Card are part of the BMW Digital Key.

The Setup Card is used to set up the main digital key. As with the Service Card, the vehicle can be unlocked/locked in an emergency using the Setup Card. The Setup Card cannot be used to turn on drive-ready state. For safety/security reasons, the Setup Card should be stored outside of the vehicle and should only be inside of the vehicle to set up and activate the main digital key.

A BMW ID or a driver profile with individual settings can be assigned to a digital key.

When using a smartphone as a digital key, the deactivated Service Card should be located in the vehicle.

The Service Card can be given to other people in situations that require the vehicle to be handed over to another person or to an authorized service center. The Service Card must be activated before it can be handed over.

Additional information:

- ▷ BMW ID, refer to page 61.
- ▷ Driver profiles, refer to page 65.
- ▷ Service Card, refer to page 76.

The BMW website provides additional information under the keyword "Digital Key".

## Functional requirements

The following functional requirements must be met for BMW Digital Key:

- ▷ The smartphone is compatible with BMW Digital Key.
- ▷ The vehicle is linked with the Connected-Drive account of the vehicle owner.
- ▷ The smartphone's rechargeable battery has sufficient charge. The necessary minimum charge of the rechargeable battery depends on the smartphone.
- ▷ Bluetooth and ultra-wideband must be enabled on the smartphone in order to use hands-free unlocking/locking with the digital key.

## Activating the main digital key with the Setup Card

Vehicle owner's smartphone is enabled as a main digital key in the vehicle. To enable, the vehicle owner must verify their authorization for the vehicle.

The Setup Card is used to set up the main digital key. A vehicle key is also required to verify authorization. The Setup Card and the My BMW App are used to start the setup process for the main digital key. Hold the Setup Card to the smartphone or scan the QR code using the smartphone camera. Follow the instructions on the smartphone.

Complete the activation of the digital master key in the vehicle. To do so, follow the instructions on the smartphone and control display. A vehicle key must be located in the vehicle for activation.

## Sharing digital keys

### General information

Digital Key allows the sharing of digital keys with other people. This is possible using the vehicle owner's smartphone or a smartphone with the corresponding authorization. This function must be supported by the smartphone.

### Forwarding authorization

To share the digital key, select the corresponding function on the smartphone, for instance in the Wallet app.

As soon as a digital key is shared with another person, the person will receive an invitation. When the invitation is accepted, the digital key on the recipient's smartphone will be activated.

### Limiting the range of functions

Certain functions of the digital key can be limited before handing it over. For example, you can disable restrictions for driving stability control systems and reduce the engine power before giving your digital key to a novice driver.

Unlock the vehicle with the corresponding digital key in order to activate a functional limitation. To turn on drive-ready state, place the smartphone in the tray. A Check Control message appears if there are active functional limitations. This Check Control message can be viewed again in the Message Center.

If there are no active functional limitations, additional digital keys or vehicle keys may have been detected. In this case, manually switch to the driver profile with the functional limitations.

For more information, refer to the Connected-Drive customer portal and the My BMW App.

### Authentication

Depending on the recipient's smartphone model, an authentication may be required for security and safety reasons.

An authorized vehicle key, a digital key with corresponding authorization, or another method may be used for authentication. Follow the corresponding instructions on the smartphone or the control display.

## Deleting digital keys

### General information

Deleted digital keys will be removed from the list of enabled digital keys.

Deleted digital keys cannot be restored.

### Deleting the main digital key

The main digital key can be deleted using a smartphone or via iDrive.

The main digital key is deleted immediately.

Any other digital keys remain active.

### Deleting a shared key

Shared keys can be deleted using a smartphone with the corresponding authorization, using the smartphone with a shared key, or via iDrive.

A key can only be deleted using a smartphone with corresponding authorization once the vehicle is used with a key other than the key to be deleted.

The deletion via the smartphone with a shared key or via iDrive is executed immediately.

### Deletion via iDrive

To delete a digital key via iDrive, an authorized vehicle key must be in the vehicle.

1. Go through the menu as follows: Apps menu / "Vehicle" / "Keys" / "Digital Key".
2. If necessary, select the digital key.
3. "Delete key"

## Resetting the function

To reset the BMW Digital Key function, an authorized vehicle key must be located in the vehicle.

Resetting the function causes all digital keys, including the main digital key, to be deleted.

After the reset, the vehicle can no longer be unlocked, locked or started with a digital key.

The Service Card's digital key will continue to work.

To reset this function, go through the menu as follows: Apps menu / "Vehicle" / "Keys" / "Digital Key" / "Reset function".

The main digital key must be enabled again to be able to use BMW Digital Key again.

## Unlocking and locking the vehicle

The vehicle can be unlocked and locked as follows:

- ▶ Using the door handle.
- ▶ With Comfort Access: depending on the national-market version, the vehicle can be locked and unlocked with no-touch activation.

Additional information:

Access to the vehicle interior, refer to page 77.

## Turning on the drive-ready state



1. To turn on drive-ready state using the BMW Digital Key, place the smartphone in

the middle of the tray with the display facing up.

## 2. Press the Start/Stop button.

With Comfort Access, it is sufficient, depending on the country, for the smartphone with Bluetooth and ultra-wideband enabled to be located inside the vehicle. Press the Start/Stop button to turn on drive-ready state.

## Sale of the smartphone

Delete all digital keys on the smartphone prior to selling the smartphone. This ensures that the smartphone can no longer be used for the vehicle.

## Changing smartphones

To use a new smartphone as a master Digital Key, activate the new smartphone according to the instructions for the master Digital Key. The previous main key can be deleted when the new smartphone is activated.

## Sale of the vehicle

Prior to selling a vehicle, reset the Digital Key function or remove the vehicle from the ConnectedDrive account of the current vehicle owner.

When the vehicle is removed from the ConnectedDrive account, all digital keys for the vehicle will be deleted. The Service Card's digital key is retained and deactivated.

## Malfunction

Your digital key may not be detected by the vehicle under the following circumstances:

- ▶ The smartphone is shielded from the sensors in the vehicle by a smartphone cover that is not suitable.
- ▶ There is an object, e.g., a chip card, between the smartphone and smartphone case.

- ▶ The connection has been interrupted by a transmission tower or other device with a high transmitting power.
- ▶ The smartphone is shielded by a building or metallic object.
- ▶ Some smartphones offer the option to protect the digital key with additional authentication. If using the digital key, the user must authenticate themselves, e.g., via PIN, fingerprint, or facial recognition.

If the recognition system is not functional, the digital key can no longer be used. If there is no other vehicle key available, the vehicle can be locked/unlocked using Remote Services in the My BMW App on another smartphone. Alternatively, the vehicle can be unlocked by the BMW ConnectedDrive call center upon request.

## BMW Digital Key Service Card

### Principle

The Service Card is part of the BMW Digital Key. A digital key that has already been paired with the vehicle is stored on the Service Card. The Service Card allows the vehicle to be unlocked/locked and started.

When using a smartphone as a digital key, the deactivated Service Card must be located in the vehicle. The Service Card can be given to other people in situations that require the vehicle to be handed over to another person. The Service Card must be activated before it can be handed over.

### General information

Service Card availability depends on vehicle equipment and national-market version.

## Safety information

### NOTICE

If the Service Card and a mobile device are in the Wireless Charging tray at the same time, the Service Card may become damaged. There is a risk of property damage. Do not place the Service Card in the Wireless Charging tray at the same time as a mobile device.

## Activating/deactivating the Service Card in the vehicle

### Functional requirements

A vehicle key or digital key must be located in the vehicle to activate and deactivate the Service Card.

### Activating the Service Card



1. To activate the Service Card, place the Service Card in the middle of the tray on the center console.
2. Follow the instructions on the control display.

### Deactivating the Service Card

To deactivate the Service Card, go through the menu as follows: Apps menu / "Vehicle" / "Keys" / "Digital Key" / "Service Card" / "Deactivate Service Card".

A deactivated Service Card will remain on the list of paired digital keys.

If using a digital key or vehicle key while an activated Service Card is detected, the control display will show an additional message to deactivate the Service Card.

## Unlocking and locking the vehicle

The vehicle can be unlocked and locked with the activated Service Card.

Additional information:

Access to the vehicle interior, refer to page 77.

## Turning on the drive-ready state



1. To turn on drive-ready state using the Service Card, place the activated Service Card in the middle of the tray on the center console.
2. Press the Start/Stop button.

Once drive-ready state is on, the Service Card can be removed from the tray.

## Malfunction

The vehicle may not be able to detect the Service Card if there are objects between the smartphone tray and the Service Card, e.g., a wallet or smartphone case.

## Access to vehicle interior

### Principle

The vehicle can be unlocked/locked as follows:

- ▶ With the vehicle key.
- ▶ Using the door handle.

- ▷ With the Service Card.
- ▷ With the BMW Digital Key.
- ▷ Hands-free unlocking/locking.
- ▷ With the My BMW app.

## Safety information

### WARNING

People or animals in the vehicle can lock the doors from the inside and lock themselves in. In this case, the vehicle cannot be opened from the outside. There is a risk of injury and danger to life. Take the vehicle key with you so that the vehicle can be opened from the outside.

### WARNING

For some national-market versions, unlocking from the inside is only possible with particular knowledge.

There is a risk of injury and danger to life if people or animals remain in the vehicle for a long period of time and are exposed to extreme temperatures. Do not lock the vehicle from the outside when there are people or animals in it. Do not leave babies, toddlers or animals alone in the vehicle.

### WARNING

Unattended children or animals in the vehicle can cause the vehicle to move and endanger themselves and traffic, for example, due to the following actions:

- ▷ Establishing standby.
- ▷ Releasing the parking brake.
- ▷ Opening and closing the doors or windows.
- ▷ Engaging selector lever position N.
- ▷ Using vehicle equipment.

There is a risk of accident, injury, and property damage. Do not leave children or animals unattended in the vehicle. Take the vehicle key with you when exiting and lock the vehicle.

### NOTICE

The window will be lowered slightly when pulling on the door handle. In the event of frost, the window may be frozen solid and may not be able to be lowered. There is a risk of property damage. When pulling on the door handle, make sure that the window is lowered. If necessary, remove snow and ice from the window. Do not open the door with force.

## Actions during unlocking

Depending on the settings, the following functions are performed when unlocking the vehicle:

- ▷ Only the driver's door and the fuel filler flap will be unlocked or all access to the vehicle will be unlocked.
- ▷ The unlocking of the vehicle can be confirmed with a light signal or a sound signal.
- ▷ The welcome light can be turned on when the vehicle is being unlocked.

In addition, the following functions are executed:

- ▷ If a BMW ID or a driver profile was assigned to the vehicle key, this BMW ID or driver profile will be activated.
- ▷ The interior lights are switched on, unless they were manually switched off.
- ▷ Depending on vehicle equipment, folded-in exterior mirrors are folded out.

If the exterior mirrors were folded in using the button inside the vehicle, they will not fold out when the vehicle is unlocked.

- ▷ Anti-theft protection is switched off.
- ▷ The alarm system is switched off.

Additional information:

- ▷ Settings, refer to page 85.
- ▷ Welcome lights, refer to page 156.
- ▷ BMW ID, refer to page 61.
- ▷ Driver profiles, refer to page 65.

## Actions during locking

Depending on the settings, the following functions are performed when locking the vehicle:

- ▷ The locking of the vehicle can be confirmed with a light signal or a sound signal.
- ▷ Depending on vehicle equipment, the exterior mirrors can be folded in automatically when locking. The exterior mirrors are not folded in when the hazard warning system is turned on.

In addition, the following functions are executed:

- ▷ All doors, the cargo area, and the fuel filler flap are locked.
- ▷ Anti-theft protection is switched on. This prevents the doors from being unlocked using the lock buttons or the door openers.
- ▷ After locking from the outside, the indicator light on the interior mirror flashes every 2 seconds.
- ▷ The alarm system is switched on.

If the drive-ready state is still turned on when you lock the vehicle, the vehicle horn will honk twice. If the vehicle honks twice, turn off drive-ready state using the Start/Stop button. If selector lever position N, or neutral, is engaged and drive-ready state is turned off, the vehicle horn will sound twice and the vehicle will not lock.

Additional information:

Settings, refer to page 85.

## With the vehicle key

### Unlocking the vehicle



To unlock the vehicle using the vehicle key, press the unlock button on the vehicle key.

If only the driver's door and fuel filler flap have been unlocked due to the settings in place, press the button on the vehicle key again to unlock the other vehicle access points.

The lighting functions may depend on the ambient brightness.

### Locking the vehicle

1. To lock the vehicle using the vehicle key, close the driver's door.



2. Press the lock button on the vehicle key.

## On the door handle

### Principle

The vehicle can be accessed without using the vehicle key.

The vehicle key is automatically detected near the vehicle.

### General information

The function is available with Comfort Access.

Depending on national-market version, the vehicle can also be unlocked and locked via the door handle using a compatible smartphone and digital key.

Additional information:

BMW Digital Key, refer to page 73.

### Functional requirements

To get inside the vehicle using the door handle, the following functional requirements must be met:

- ▶ Carry the vehicle key with you, e.g., in your pants pocket.
- ▶ Bluetooth must be activated on the smartphone to unlock and lock using the digital key.
- ▶ To lock the vehicle, the vehicle key must be outside of the vehicle near the doors.
- ▶ After locking, approx. 2 seconds must elapse before unlocking is possible.

### Unlocking the vehicle using the door handle

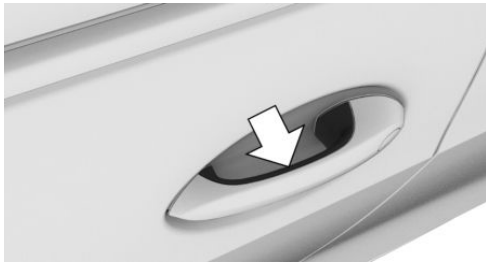

To unlock the vehicle using the door handle, reach into the recessed grip on one of the front doors.

### Locking the vehicle with the door handle

1. To lock the vehicle using the door handle, close the driver's door.
2. Touch the grooved surface on the closed front door handle for approx. 1 second and hold it there without gripping the door handle.

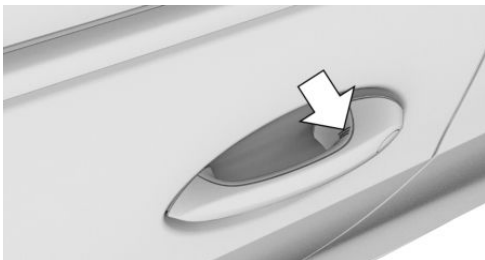

### Malfunction

Wet or snowy conditions may disrupt the locking request detection on the door handles.

In the case of a malfunction, unlock and lock the vehicle using the buttons of the vehicle key or use the integrated key.

### Touchless unlocking/locking of the vehicle

#### Principle

The vehicle will be unlocked when an authorized vehicle key is detected in the unlocking zone.

The unlocking zone is located within a radius of approx. 5 ft/1.50 m around the side and rear of the vehicle.

The vehicle will be locked when the vehicle key leaves the locking zone.

The locking zone is located within a radius of approx. 9 ft/3 m around the side and rear of the vehicle.

Automatic unlocking and locking must be activated in the settings.

#### General information

The function is available with Comfort Access.

Depending on the national-market version, touchless unlocking and locking is also possible for compatible smartphones with a digital key. To use the digital key for hands-free locking/unlocking, Bluetooth must be enabled on the smartphone.

If the vehicle key is located in the unlocking zone for an extended period of time without movement, the vehicle will be locked automatically.

Depending on vehicle equipment, the following restrictions apply if someone is detected on a seat when the vehicle is locked:

- ▶ The vehicle will be locked but not secured against theft.
- ▶ The alarm system is not activated.
- ▶ The fuel filler flap remains unlocked.

Additional information:

BMW Digital Key, refer to page 73.

### Actions during unlocking

If the settings specify that only the driver's door and the fuel filler flap will be unlocked, note the following:

The driver's door and fuel filler flap will only unlock when the driver is within the driver's door unlocking zone.

Additional information:

Settings, refer to page 85.

### Functional requirements

To unlock/lock the vehicle hands-free, the following functional requirements must be met:

- ▶ Carry the vehicle key with you, e.g., in your pants pocket.
- ▶ Bluetooth and ultra-wideband must be enabled on the smartphone in order to use hands-free unlocking/locking with the digital key.
- ▶ Automatic unlocking and locking must be activated in the settings.
- ▶ The drive-ready state must be turned off.
- ▶ If the vehicle has been in idle for several days, the vehicle must be driven first in order to use hands-free unlocking/locking.

Additional information:

Settings, refer to page 85.

### With the Service Card

#### Principle

The Service Card is a chip card on which the digital key is stored. The Service Card can be used to unlock and lock the vehicle.

Additional information:

Service Card, refer to page 76.

### Unlocking/locking the vehicle with the Service Card

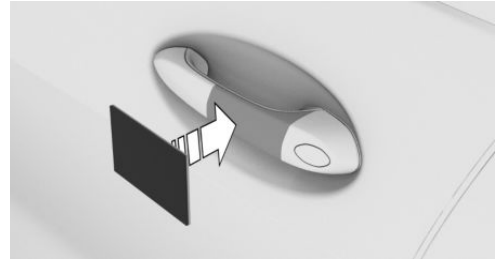

Hold the activated Service Card directly over the middle of the driver's door handle.

When locking the vehicle with the Service Card, make sure that all doors and the cargo area are closed.

If the Service Card is not detected, change the position of the Service Card slightly and repeat the procedure.

### With the BMW Digital Key

#### Principle

Depending on vehicle equipment and national-market version, a digital key can be installed on a compatible smartphone and used to unlock and lock the vehicle.

Additional information:

BMW Digital Key, refer to page 73.

## Unlocking/locking the vehicle with the BMW Digital Key

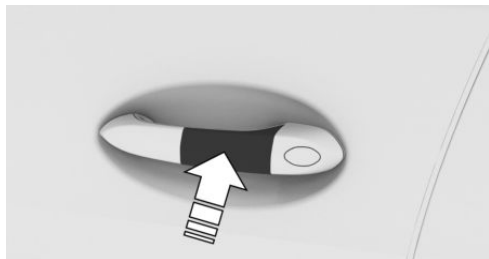

Hold the smartphone NFC antenna directly at the center of the driver's door handle. The position of the near field communication antenna depends on the smartphone model.

When locking the vehicle with the smartphone, make sure that all doors and the cargo area are closed.

### With the My BMW App

The My BMW App Remote Services include options to lock and unlock a vehicle, among other functions.

This requires an active BMW ConnectedDrive contract, and the My BMW App must be installed on the smartphone used.

## Access to the cargo area

### Principle

The cargo area can be opened and closed as follows:

- ▶ With the vehicle key.
- ▶ In the cargo area.
- ▶ Inside the vehicle.

Depending on the equipment:

Hands-free opening.

## Safety information

### **⚠ WARNING**

Body parts can be jammed when operating the trunk lid. There is a risk of injury. Make sure that the travel path of the trunk lid is clear while opening and closing.

### **⚠ WARNING**

While opening, the trunk lid pivots back and up. There is a risk of injury and risk of property damage. Make sure that the travel path of the trunk lid is clear while opening and closing.

## With the vehicle key

### General information

To avoid locking the vehicle key in the vehicle, do not place the vehicle key in the cargo area.

Depending on vehicle equipment and national-market version, the following settings can be changed:

- ▶ Unlocking the cargo area with the vehicle key also unlocks the doors.
- ▶ Before unlocking the cargo area with the vehicle key, first unlock the vehicle.

### Functional requirements

To access the cargo area using the vehicle key, the following functional requirements must be met:

- ▶ Selector lever position P must be engaged to open the cargo area with the vehicle key.
- ▶ You must enable the setting for opening with the vehicle key.

Additional information:

Settings, refer to page 85.

## Opening the cargo area



On the vehicle key, press and hold the button for opening the cargo area for approx. 1 second.

## On the cargo area

### General information

With Comfort Access, the cargo area can be accessed without activating the vehicle key.

The key is automatically detected near the vehicle.

Depending on the national-market version, compatible smartphones with a digital key are also detected automatically. In this case, the cargo area can be opened with a smartphone.

Additional information:

BMW Digital Key, refer to page [73](#).

### Functional requirements

To access the cargo area using the cargo area, the following functional requirements must be met:

- ▶ Carry the vehicle key with you, e.g., in your pants pocket.
- ▶ Bluetooth must be activated on the smartphone to detect the digital key.

## Opening the cargo area

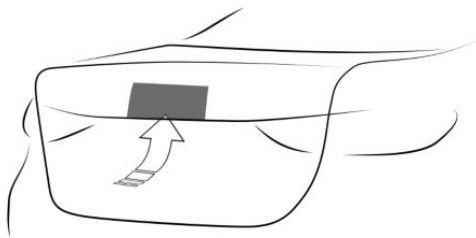

The cargo area can be opened as follows:

- ▶ Unlock the vehicle, then press the button on the cargo area.
- ▶ With Comfort Access: Carry the vehicle key with you and press the button on the cargo area.

Locked doors are not unlocked.

## Closing the cargo area manually

To close, pull the cargo area lid downward using the recessed grips.

## In the interior

### Opening the cargo area



To open the cargo area, press the open button for the cargo area on the driver's door.

## Opening the cargo area hands-free

### Principle

You can open the cargo area contactlessly when carrying the vehicle key on your person. Sensors detect specific foot movements near the center of the rear area, and the cargo area opens.

### General information

This function is available with Comfort Access and depends on the national-market version.

If the vehicle key is within sensor range, the cargo area may open inadvertently if you unintentionally move your foot or if foot movement is detected.

The sensor has an approximate range of 5 ft/1.50 m extending from the rear area.

If contactless opening is used for the cargo area, the locked doors will not be unlocked.

Depending on the national-market version, hands-free opening/closing of the cargo area may also be possible for compatible smartphones with a digital key.

Additional information:

BMW Digital Key, refer to page 73.

## Safety information

### **WARNING**

With hands-free opening of the cargo area, there may be unintentional contact with vehicle parts, e.g., hot exhaust system. There is a risk of injury. When moving your foot, make sure you have a firm stance and do not touch the vehicle.

### **NOTICE**

When using rear carriers, the cargo area may open unintentionally if the trailer socket is not occupied. If opened unintentionally, the trunk lid may collide with the rear carrier. There is a risk of property damage. Do not carry the vehicle key with you when mounting a rear carrier. When using rear carriers, make sure that the trailer socket is occupied.

## Functional requirements

To open the cargo area hands-free, the following functional requirements must be met:

- ▶ Selector lever position P must be engaged.
- ▶ Contactless opening of the cargo area must be enabled in settings.
- ▶ Bluetooth must be enabled on the smartphone to open the cargo area contactlessly using your digital key.

Additional information:

Settings, refer to page 85.

## Hands-free opening of the cargo area

1. To open the cargo area hands-free, walk behind the vehicle with the vehicle key, holding it in the middle at the rear of the

vehicle, approximately one arm's length away.

2. Move your foot under the vehicle in the driving direction and pull it back immediately. During these movements, the foot must be passed through the range of the sensor.

If necessary, move the foot slightly to the right or left of center again.

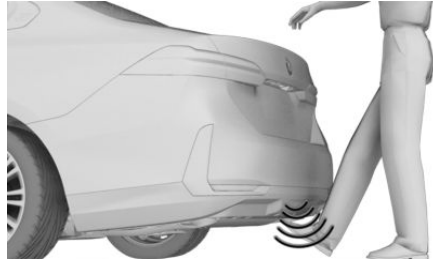

Before the cargo area opens, the hazard warning system flashes.

## System limits

The detection of the foot movement may be limited due to the following external conditions:

- ▶ Ice, snow or slush on the rear of the vehicle.
- ▶ Dirt or road salt on the rear of the vehicle.
- ▶ If the sensors are dirty or covered, e.g., by stickers or covers of any kind.
- ▶ After paint work was done incorrectly on the rear of vehicle.

Movement in range of the sensors may cause the cargo area to open unintentionally, e.g., when objects are lifted quickly near the vehicle rear or due to the moving brushes in a car wash. To prevent such unintended opening of the cargo area in such cases, keep the vehicle key at a sufficient distance from the rear of the vehicle.

## Emergency cargo area release



Pull the handle inside the cargo area.  
The cargo area is unlocked.

## Buttons for the central locking system

### Principle

The vehicle can be locked/unlocked from the inside using the central locking system buttons.

The vehicle is automatically locked when driving off.

In the event of a severe accident, the vehicle is automatically unlocked. The hazard warning system and interior lights are illuminated.

### Overview

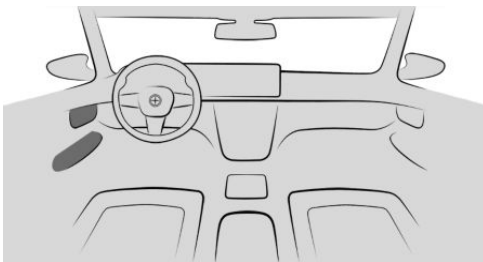

The central locking buttons are located on the front door.



The lock button.



The unlock button.

### Locking the vehicle from inside



To lock the vehicle from the inside, press the lock button on the front door when the front doors are closed.

If the vehicle was locked from the inside, the LED in the button illuminates.

The fuel filler flap remains unlocked.

The vehicle is not secured against theft when locking.

### Unlocking the vehicle from inside



To unlock the vehicle from the inside, press the unlock button on the front door.

### Opening the door

When the vehicle is locked, doors can be opened as follows:

- ▶  On the front door, press the unlock button to unlock the doors together.  
Pull the door opener above the armrest.
- ▶ Front doors: Pull the door opener on the door to be opened. The other doors remain locked.
- ▶ Rear doors: Pull the door opener on the door to be opened twice: The first time unlocks the door, the second time opens it. The other doors remain locked.

## Settings

### General information

Depending on the equipment and national-market version, various settings for opening and closing are possible.

## Unlocking and locking

### Doors

1. To unlock/lock the doors, go through the menu as follows: Apps menu / "Vehicle" / "Doors and windows" / "Lock" / "Lock/unlock" / "Unlock".
2. Select the desired setting:
  - ▷ "Driver's door only"  
Only the driver's door and fuel filler flap are unlocked. Pressing again unlocks the entire vehicle.
  - ▷ "All doors"  
The entire vehicle is unlocked.

### Touchless unlocking/locking

1. To unlock/lock the vehicle hands-free, go through the menu as follows: Apps menu / "Vehicle" / "Doors and windows" / "Lock" / "Lock/unlock".
2. Select the desired setting:
  - ▷ "Unlock when approaching"
  - ▷ "Lock when walking away"  
Enabling this setting also activates automatic folding of the mirrors. Automatic folding of the mirrors can be deactivated again in the corresponding menu.

### Automatic unlocking

1. To unlock the vehicle automatically, go through the menu as follows: Apps menu / "Vehicle" / "Doors and windows" / "Lock" / "Lock/unlock".
2. Select the desired setting:
  - ▷ "Unlock doors at end of trip"
  - ▷ "Unlock doors when in P"

If locked, the vehicle unlocks automatically when drive-ready state is turned off or selector lever position P is engaged.

### Automatic locking

To lock the vehicle automatically, go through the menu as follows: Apps menu / "Vehicle" / "Doors and windows" / "Lock" / "Lock/unlock" / "Lock after a short time".

The vehicle locks automatically after a short period of time if no door is opened after unlocking.

### Confirmation signals from the vehicle

1. To adjust the vehicle confirmation signal, go through the menu as follows: Apps menu / "Vehicle" / "Doors and windows" / "Lock" / "Lock/unlock".
2. Select the desired setting:
  - ▷ "Flash when unlocking"  
Unlocking is confirmed by two flashes.
  - ▷ "Flash when locking"  
Locking is confirmed by one flash.
  - ▷ With alarm system:  
"Sound on lock/unlock"  
Unlocking is confirmed with two sound signals, locking is confirmed with one sound signal.

### Folding mirrors in automatically

To configure the side mirrors to fold in automatically, go through the menu as follows: Apps menu / "Vehicle" / "Doors and windows" / "Lock" / "Lock/unlock" / "Fold mirrors on lock/unlock".

### Cargo area

#### Cargo area button on vehicle key

It is possible to choose where to assign the cargo area button on the vehicle key.

1. Go through the menu as follows: Apps menu / "Vehicle" / "Keys" / "Vehicle key" / "Tailgate button".
2. Select the desired setting:

- ▷ "Tailgate"
 

Depending on the equipment, the cargo area will be unlocked or opened.
- ▷ "Tailgate and door(s)"
 

Depending on the equipment, the cargo area will be unlocked or opened and the doors are unlocked.
- ▷ "Tailgate will only open if vehicle is already unlocked"
 

The vehicle must be unlocked before the cargo area can be operated with the vehicle key.
- ▷ "Lock tailgate button"
 

Operating the cargo area with the vehicle key is disabled.

## Opening the cargo area hands-free

1. To configure the settings for hands-free opening/closing of the cargo area, go through the menu as follows: Apps menu / "Vehicle" / "Doors and windows" / "Tailgate"
2. Select the desired setting:
  - ▷ "Open with foot movement"

## Window

### Opening windows automatically

1. To configure the settings for automatic opening of the windows, go through the menu as follows: Apps menu / "Vehicle" / "Doors and windows"
2. Select the desired setting.

If this setting is enabled, the driver's window opens automatically as soon as the vehicle reaches the saved location.

## Alarm system

### Principle

The alarm system issues a visual and acoustic signal when someone attempts to open the locked vehicle incorrectly.

### General information

When the vehicle is locked, the vehicle alarm system reacts to the following changes:

- ▷ If a door, the hood, or the cargo area is opened.
- ▷ If movement is detected inside the vehicle.
- ▷ If the vehicle has a different tilt, e.g., due to an attempt to steal a wheel or when towing.
- ▷ If the battery voltage is interrupted.
- ▷ If the diagnostic socket is used incorrectly.
- ▷ If the vehicle is locked while a device is connected to the diagnostic socket.

The alarm system signals these changes visually and acoustically:

- ▷ Acoustic alarm:
 

Depending on local regulations, the acoustic alarm may be suppressed.
- ▷ Optical alarm:
 

By flashing of the hazard warning system and headlights, where required.

Do not modify the system to ensure function of the alarm system.

### Turning the alarm system on/off

The alarm system is activated or deactivated as soon as the vehicle is locked or unlocked.

The alarm system does not turn on if the vehicle is locked manually from the inside.

## Opening the doors with the alarm system switched on

The alarm system is triggered when a door is opened if the door was unlocked using the integrated key in the door lock.

## Opening the cargo area with the alarm system switched on

The cargo area can be opened even when the alarm system is switched on.

After closing the cargo area, the cargo area will be locked and monitored again. The hazard warning system flashes once during closing.

## Panic mode

You can trigger the alarm system if you find yourself in a dangerous situation.



- ▶ Press the button on the vehicle key and hold for at least 3 seconds.
- ▶ Briefly press the button on the vehicle key three times in succession.

To switch off the alarm: press any button.

## Indicator light on the interior mirror

The indicator light on the interior mirror shows the status of the alarm system:



- ▶ The indicator light flashes briefly every 2 seconds:  
The alarm system is switched on.
- ▶ The indicator light flashes for approx. 10 seconds, then flashes briefly every 2 seconds:

The interior motion sensor and tilt alarm sensor are not activated because the doors, hood, or tailgate are not closed correctly. Correctly closed access points are secured.

The interior motion sensor and tilt alarm sensor will turn on when all open access points are closed.

- ▶ The indicator light flashes even though all access points have been closed:  
Alarm system error.
- ▶ The indicator light goes out after unlocking:  
The vehicle has not been tampered with.
- ▶ The indicator light flashes after unlocking until drive-ready state is switched on, but no longer than approx. 5 minutes:  
The alarm has been triggered.

## Tilt alarm sensor

The tilt alarm sensor is part of the alarm system and monitors the vehicle's tilt.

The alarm system triggers, for example, when someone attempts to steal a wheel or when the vehicle is towed.

## Interior motion sensor

The interior motion sensor is part of the alarm system and monitors the vehicle interior.

The alarm system triggers when movement is detected inside the vehicle.

The windows and/or the glass sunroof must be closed for this system to function properly.

## Avoiding unintentional alarms

### General information

The tilt alarm sensor and interior motion sensor can trigger an alarm, although no unauthorized action occurred.

An unintentional alarm can be triggered in the following situations:

- ▷ In car washes.
- ▷ In duplex garages.
- ▷ During transport on trains carrying vehicles, at sea or on a trailer.
- ▷ With animals in the vehicle.
- ▷ When the vehicle is locked after start of re-fueling.

The tilt alarm sensor and the interior motion sensor can be switched off in such situations.

### Switching off the tilt alarm sensor and interior motion sensor

The tilt alarm sensor and interior motion sensor can be turned off as follows:

- ▷  As soon as the vehicle is locked, press the lock button on the vehicle key within 30 seconds.

The indicator light illuminates for approx. 2 seconds and then continues to flash.

- ▷ After turning off the standby state, an option to turn off the interior motion sensor and the tilt alarm sensor will be displayed on the control display.
- ▷ With a digital key via the My BMW App.

The tilt alarm sensor and interior motion sensor are deactivated until the vehicle is locked again.

### Ending the alarm

To stop the alarm, unlock the vehicle.

If the vehicle is unlocked with the integrated key, the drive-ready state must subsequently be turned on via the emergency detection of the vehicle key.

## Window

### Principle

The windows can be operated as follows:

- ▷ With the vehicle key.
- ▷ Using the door handle.
- ▷ Using the switches inside the vehicle.

### Safety information

#### **WARNING**

When operating the windows, body parts and objects can be jammed. There is a risk of injury and risk of property damage. Make sure that the travel path of the windows is clear while opening and closing.

### With the vehicle key

#### Opening windows with the vehicle key



To open the windows with the vehicle key, unlock the vehicle, then press and hold the unlock button on the vehicle key.

The windows open for as long as the button on the vehicle key is pressed.

#### Closing windows with the vehicle key



With Comfort Access: To close the windows with the vehicle key, lock the vehicle, then press and hold the lock button on the vehicle key.

The windows close for as long as the button on the vehicle key is pressed.

Depending on the vehicle equipment, exterior mirrors are folded in unless they were folded in while locking. The exterior mirrors are not folded in when the hazard warning system is turned on.

## On the door handle

### Principle

The windows can be closed using the door handle without operating the vehicle key.

The vehicle key is automatically detected near the vehicle.

### General information

Function availability depends on vehicle equipment.

Depending on national-market version, the windows can also be closed via the door handle using a compatible smartphone and digital key.

Additional information:

BMW Digital Key, refer to page 73.

### Functional requirements

To close the windows using the door handle, the following functional requirements must be met:

- ▶ Carry the vehicle key with you, e.g., in your pants pocket.
- ▶ Bluetooth must be activated on the smartphone to close the window(s) using the digital key.

### Closing windows with the door handle

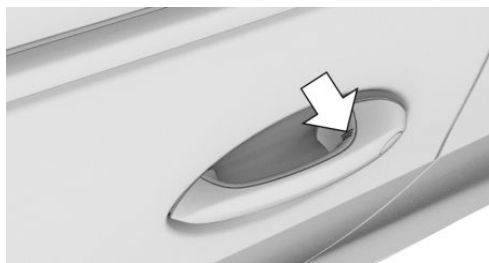

To close a window using the door handle, touch the grooved surface on the closed front door handle and hold it there without gripping the door handle.

In addition to locking, the windows and glass sunroof with sun protection will be closed.

Depending on the vehicle equipment, exterior mirrors are folded in unless they were folded in during locking. The exterior mirrors are not folded in when the hazard warning system is turned on.

## Inside the vehicle

### Overview

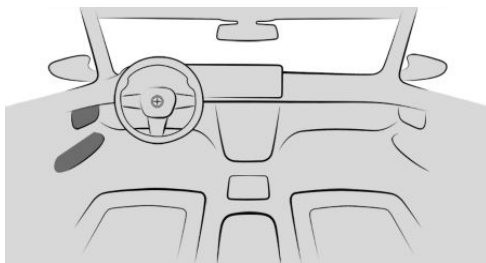



The power window switches are located on the doors.

### Functional requirements

The vehicle key or a digital key is inside the vehicle.

### Opening windows



To open the windows, proceed as follows:

- ▶  On the door, press the power window switch to the resistance point. The window opens while the switch is being held.
- ▶  On the door, press the power window switch past the resistance point.

The window opens automatically. Pressing the switch again stops the motion.

### Closing the windows

To close the windows, proceed as follows:

- ▷  On the door, pull the power window switch to the resistance point.  
The window closes while the switch is being held.
- ▷  On the door, pull the power window switch past the resistance point.  
The window closes automatically.  
Pulling again stops the motion.

The window closes with limited anti-trap mechanism. If the closing force exceeds a certain threshold, closing is stopped.

2.  On the door, pull the power window switch past the resistance point again within approx. 4 seconds and hold it there.  
The window closes without the anti-trap mechanism.

## Anti-trap mechanism

### Principle

The anti-trap mechanism prevents objects or body parts from becoming trapped between the door frame and window glass while a window is closing.

### General information

If resistance or blockage is detected while a window is being closed, the closing will be interrupted.

### Safety information

#### WARNING

Accessories on the windows such as antennas can impact anti-trap mechanism. There is a risk of injury. Do not install accessories in the travel path of the windows.

### Closing without the anti-trap mechanism

In case of danger from the outside or if icing might prevent normal closing, proceed as follows:

1.  On the door, pull the power window switch past the resistance point and hold it.

### Opening windows automatically

If the driver's window is frequently opened in the same location, the window can be set to open automatically. This is useful if you frequently use the same parking garage, for example.

For the driver's window to open automatically, the vehicle speed must be below 6 mph/10 km/h and there must be sufficient GPS reception.

Additional information:

Settings, refer to page 85.

## Safety switch

### Principle

The safety switch can be used to prevent children, for instance, from opening and closing the rear windows using the switches in the rear.

If an accident of a certain severity occurs, the safety function is switched off automatically.

## Overview

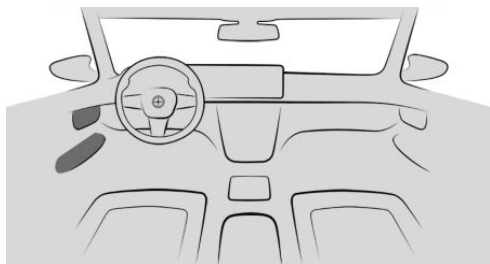

 The safety switch is located on the driver's door.

## Turning the safety functions on/off

 To activate/deactivate the safety function, press the safety switch on the driver's door.

The LED in the button illuminates when the safety function is switched on.

## Glass sunroof

### Safety information

#### **WARNING**

Body parts can be jammed when operating the glass sunroof. There is a risk of injury. Make sure that the area of movement of the glass sunroof is clear during opening and closing.

### Principle

The glass sunroof can be operated as follows:

- ▷ With the vehicle key.
- ▷ Using the door handle.
- ▷ Inside the vehicle.

## With the vehicle key

### Opening glass sunroof



To open the glass sunroof, unlock the vehicle, then press and hold the unlock button on the vehicle key.

The glass sunroof with sun protection will be opened for as long as the button on the vehicle key is pressed.

### Closing glass sunroof



With Comfort Access: To close the glass sunroof, lock the vehicle, then press and hold the lock button on the vehicle key when close to the vehicle.

The glass sunroof with sun protection will be closed for as long as the button on the vehicle key is pressed.

Depending on the vehicle equipment, exterior mirrors are folded in unless they were folded in while locking. The exterior mirrors are not folded in when the hazard warning system is turned on.

## On the door handle

### Principle

The glass sunroof can be closed using the door handle without operating the vehicle key.

The vehicle key is automatically detected near the vehicle.

### General information

Function availability depends on vehicle equipment.

Depending on the country, the glass sunroof can also be closed via the door handle using compatible smartphones and your digital key.

Additional information:

BMW Digital Key, refer to page [73](#).

## Functional requirements

To close the glass sunroof using the door handle, the following functional requirements must be met:

- ▷ Carry the vehicle key with you, e.g., in your pants pocket.
- ▷ Bluetooth must be activated on the smartphone to close the glass sunroof using the digital key.

## Closing glass sunroof

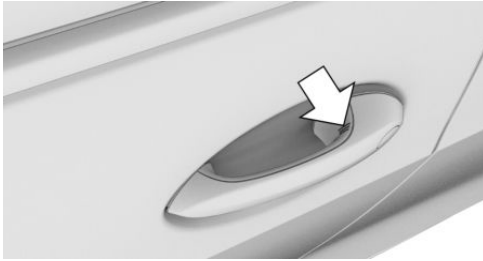

To close the glass sunroof using the door handle, touch the grooved surface on the closed front door handle and hold it there without gripping the door handle.

In addition to locking, the windows and glass sunroof with sun protection will be closed. Depending on the vehicle equipment, exterior mirrors are folded in unless they were folded in while locking. The exterior mirrors are not folded in when the hazard warning flashers are switched on.

## Inside the vehicle

### General information

The glass sunroof and the sun protection are operated using the same switch.

## Overview

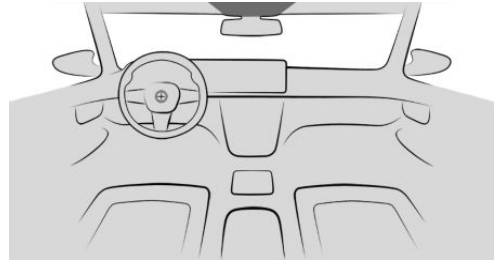

The glass sunroof/sun protection switch is located in the headliner.

## Functional requirements

The glass sunroof and sun protection can be operated under the following conditions:

- ▷ Standby state is switched on.
- ▷ Drive-ready state is switched on.

The vehicle key must be inside the vehicle.

## Lifting/closing glass sunroof



To raise/close the glass sunroof, briefly press the glass sunroof/sun protection switch in the headliner upward.

- ▷ The closed glass sunroof tilts and the sun protection opens slightly.
- ▷ The opened glass sunroof closes until it is in the tilted position. The sun protection does not move.
- ▷ The tilted glass sunroof closes.

## Opening/closing the glass sunroof and sun protection separately

To open/close the glass sunroof and sun protection separately, proceed as follows:

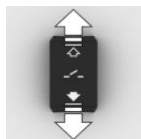

▷ In the headliner, push the glass sunroof and sun protection switch back to the resistance point and hold it. Holding down the switch opens the sun protection. If the sun protection is already completely open, the glass sunroof opens.

- ▷ Push the switch forward to the resistance point and hold. The glass sunroof closes while the switch is being held. If the glass sunroof is already closed or tilted, the sun protection closes.
- ▷ Push the switch back past the resistance point. The sun protection opens automatically. If the sun protection is already completely open, the glass sunroof opens automatically. Pressing the switch again stops the motion.
- ▷ Push the switch forward past the resistance point. The glass sunroof closes automatically. If the glass sunroof is already closed or tilted, the sun protection closes automatically. Pressing the switch again stops the motion.

### Opening/closing the glass sunroof and sun protection together

To open/close the glass sunroof and sun protection together, proceed as follows:

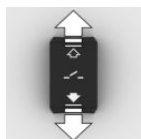

▷ In the headliner, push the glass sunroof and sun protection switch back twice, in quick succession, past the resistance point. The glass sunroof and sun protection open together.

Pressing the switch again stops the motion.

- ▷ Briefly push the switch out and forward, twice in quick succession, past the resistance point. The glass sunroof and sun protection close together. Pressing the switch again stops the motion.

### Comfort position

On some models, there is less wind noise inside the vehicle when the glass sunroof is not fully open. In these models, the automatic function initially only opens the glass sunroof up to this comfort position.

Pressing the glass sunroof and sun protection switch in the headliner opens the glass sunroof fully.

### Anti-trap mechanism

#### Principle

The anti-trap mechanism prevents objects or body parts from becoming jammed between the roof frame and glass sunroof while the glass sunroof is closing.

If resistance or a blockage is detected while the glass sunroof is closing, it will stop closing when the roof reaches the half-open position or when closing from the tilted position.

### Closing from the open position without the anti-trap mechanism

In case of danger from the outside or if icing might prevent normal closing, proceed as follows:

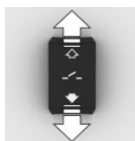

1. Close all doors.
2. Turn on drive-ready state or stop the vehicle if moving.
3. In the headliner, push the glass sunroof/sun protection switch forward, past the resistance point, and hold it there.  
The glass sunroof closes with limited anti-trap mechanism. If the closing force exceeds a certain threshold, closing is stopped.
4. Push the switch forward again past the resistance point and hold, until the glass sunroof closes without the anti-trap mechanism. Make sure that the closing path is clear.

### Closing from the lifted position without the anti-trap mechanism

In case of danger from the outside or if icing might prevent normal closing, proceed as follows:

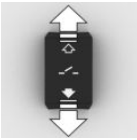

1. Close all doors.
2. Turn on drive-ready state or stop the vehicle if moving.
3. In the headliner, push the glass sunroof/sun protection switch forward, past the resistance point, and hold it there.

### Initializing after a power interruption

#### General information

After a power interruption during the opening or closing process, the glass sunroof can only be operated to a limited extent. Initializing the system can help in this case.

The system can be initialized under the following conditions:

- ▶ The vehicle is parked in a horizontal position.
- ▶ The vehicle will not be moved until the initialization is completed.
- ▶ The drive-ready state is established.
- ▶ The outside temperature is above 41°F/5°C.

During initialization, the glass sunroof closes without the anti-trap mechanism.

Make sure that the closing path is clear.

### Initializing the system



To initialize the system, in the headliner, press the glass sunroof/sun protection switch upward and hold it until initialization is complete:

Initialization begins within 15 seconds.

- ▶ If the glass sunroof is closed, it opens then closes again.
- ▶ If the glass sunroof is open, it first closes, then opens and closes again.
- ▶ The sun protection is initialized in the closed position.

Initialization is complete once the glass sunroof and the sun protection have opened then closed again.

# Seats, mirrors and steering wheel

## Vehicle features and options

This chapter describes model-specific equipment, systems, and functions that are currently available, or may become available in the future, even if they are not present in the vehicle.

Additional information:

Vehicle equipment, refer to page 8.

## Sitting safely

An ideal seat position that meets the needs of the occupants can make a vital contribution to relaxed, fatigue-free driving.

In the event of an accident, having the correct seat position and using the protection systems correctly both play an important role. Follow the information in the following chapters:

- ▷ Front seats, refer to page 96.
- ▷ Seat belts, refer to page 100.
- ▷ Head restraints, refer to page 103.
- ▷ Airbags, refer to page 164.

## Front seats

### Safety information

#### **WARNING**

Seat setting while driving can lead to unexpected movements of the seat. There is a risk of accident, injury, and property damage. Only adjust the seats when the vehicle is stationary.

#### **WARNING**

With a backrest inclined too far to the rear, the protective effect of the seat belt can no longer be ensured. There is a risk of sliding under the seat belt in an accident. There is a risk of injury and danger to life. Adjust the seat prior to starting the trip. Adjust the backrest so that it is in the most upright position as possible and do not adjust again while driving.

#### **WARNING**

There is a danger of jamming when moving the seats. There is a risk of injury and risk of property damage. Make sure that the travel path of the seat is clear prior to any adjustment.

## Manually adjustable seats

### Principle

Manually adjustable seats are operated using the levers on the seat.

### Overview



The levers for setting the seats are located on the front seats.

## Setting the longitudinal direction

### WARNING

If a seat is not locked, it may move unexpectedly while driving. Vehicle control could be lost. There is a risk of accident, injury, and property damage. After adjusting, move the seat forward or back slightly, making sure the seat engages properly.

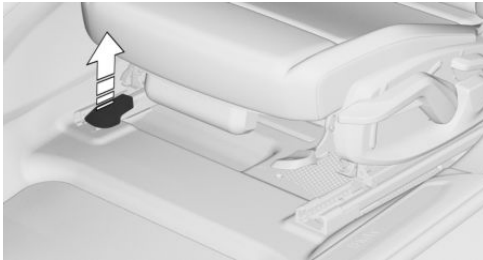

To adjust the longitudinal direction, pull up the longitudinal direction lever at the front of the seat and push the seat in the desired direction.

## Adjusting seat tilt

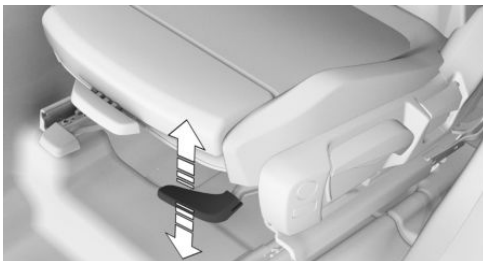

To adjust the seat tilt: On the front of the seat, push the seat tilt lever up or down as many times as necessary for the seat to reach the desired tilt.

## Adjusting the height

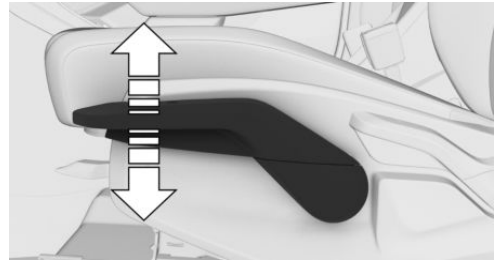

To adjust the height: On the side of the seat, push the front seat height lever up or down as many times as necessary for the seat to reach the desired height.

## Adjusting backrest tilt

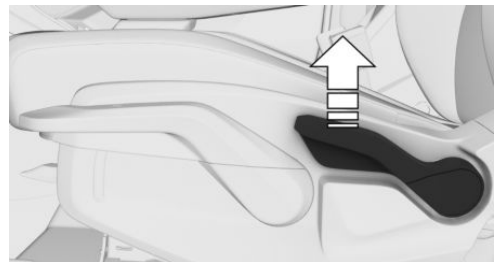

To adjust the backrest angle, pull the backrest tilt lever on the side of the seat and tighten or loosen the backrest as required.

## Electrically adjustable seats

### Principle

Electrically adjustable seats are operated using the switches on the seat.

The current seat position can be stored using the memory function.

Additional information:

Memory function, refer to page [108](#).

## Overview

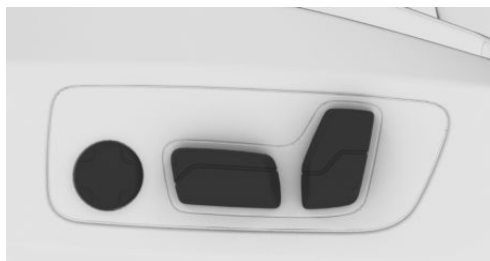

The switches for setting the seats are located on the front seats.

## Adjusting seat tilt

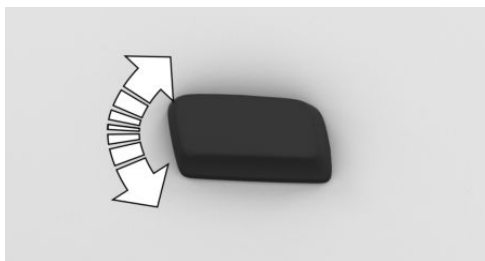

To adjust the seat tilt, flip the seat tilt switch up or down.

## Setting the longitudinal direction

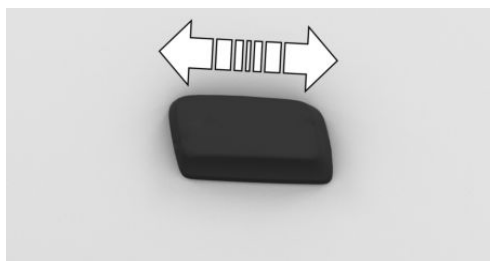

To adjust the longitudinal direction, push the longitudinal direction switch on the seat forward or backward.

## Adjusting backrest tilt

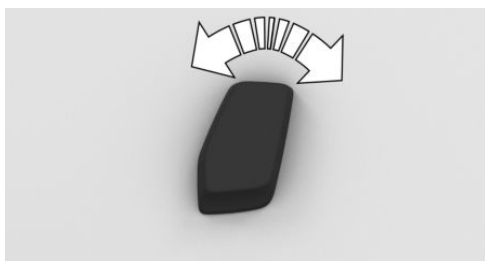

To adjust the backrest tilt, flip the backrest tilt switch forward or backward.

## Adjusting the height

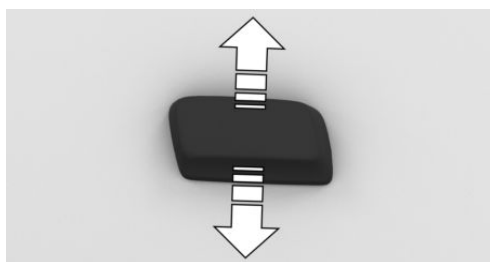

To adjust the seat height, press the seat height switch up or down.

## Thigh support

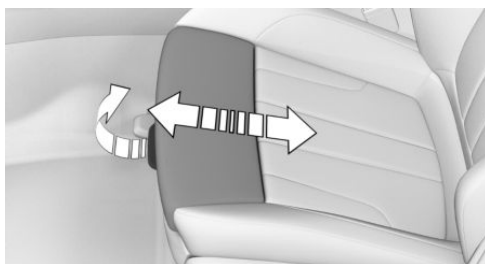

To adjust the thigh support, pull the thigh support lever at the front of the seat then push the thigh support forward or backward.

## Lumbar support

### Principle

The curvature of the seat backrest can be adjusted in a way that it supports the lumbar region of the spine. The lower back and spine are supported to promote an upright sitting position.

### Adjusting the lumbar support

To adjust the lumbar support, proceed as follows:



- ▶ To increase or decrease the bulge, press the lumbar support button forward or backward.
- ▶ To move the bulge up or down, press the lumbar support button up or down.

### Functional limitation

It may not be possible to adjust the lumbar support at very high and very low temperatures.

## Lumbar support and backrest width: M Sport seat

### Principle

The curvature of the seat backrest can be adjusted in a way that it supports the lumbar region of the spine. The lower back and spine are supported to promote an upright sitting position.

Adjusting the backrest width may improve side support when cornering.

The backrest width is changed by adjusting the side sections of the backrest.

### Adjusting the lumbar support

To adjust the lumbar support, proceed as follows:



- ▶ To increase the bulge, press the lumbar support button on the front of the seat.
- ▶ To reduce the bulge, press the lumbar support button on the back of the seat.

### Adjusting the backrest width

To adjust the backrest width, proceed as follows:



- ▶ To reduce the backrest width, press the top backrest width button.
- ▶ To increase the backrest width, press the bottom backrest width button.

## Seat massage

### Principle

Using the seat massage helps relax the muscles and improve circulation in the lumbar region, which, in turn, helps prevent fatigue.

### Seat massage menu



- ▶ To go directly to the Seat Massage menu on the control display, press the lumbar support button on the seat.

### Turning the seat massage on/off

To turn the seat massage on/off, proceed as follows:

1. Go through the menu as follows via iDrive: Apps menu / "Vehicle" / "Seat comfort".
2. Select the desired seat.
3. "Seat massage"
4. Select the desired setting, as necessary.

The seat massage is stopped when the lumbar support is operated.

## Calibrating the front seats

### Principle

If the electric seat adjuster is no longer working properly, the driver's seat is calibrated automatically. The driver's seat is calibrated automatically after the vehicle is exited and the doors closed.

If the driver's seat cannot be calibrated automatically or calibration of the front passenger seat is required, a Check Control message appears on the control display. The front seats must be calibrated in order for the electric seat adjuster to work properly again.

### Safety information

#### WARNING

There is a danger of jamming when moving the seats. There is a risk of injury and risk of property damage. Make sure that the travel path of the seat is clear prior to any adjustment.

### Functional requirements

To calibrate the front seats, the following functional requirements must be met:

- ▶ Selector lever position P is engaged.
- ▶ The seat to be calibrated is unoccupied.

### Calibrating the front seat manually

1. To calibrate the rear seat position, press and hold the longitudinal direction switch backward until the seat stops.
2. Repeat step 1 until the seat stops then moves slightly in the opposite direction. The rear end position is calibrated.

3. To calibrate the front seat position, press and hold the longitudinal direction switch forward until the seat stops.
4. Repeat step 3 until the seat stops then moves slightly in the opposite direction. The front end position is calibrated.

As soon as the message on the control display disappears, the calibration is complete. If the message remains active, repeat the calibration.

If the message is still shown after repeated calibration, have the vehicle checked by an authorized service center or another qualified service center or repair shop.

## Comfort exit

### Principle

The comfort exit setting makes it easier to get in/out of the vehicle by automatically adjusting the seat position and moving the seat back.

### Activating/deactivating comfort exit

1. To activate/deactivate Comfort Exit, go through the menu as follows: Apps menu / "Vehicle" / "Seat comfort" / "Comfort exit".
2. Select the desired setting.

## Seat belts

### Principle

The vehicle is fitted with five seat belts to ensure occupant safety. However, they can only offer protection when adjusted correctly.

Always make sure that seat belts are being worn by the occupants before driving off. The airbags supplement the seat belts as an additional safety device. The airbags do not replace seat belts.

All seat belt anchorage points are designed to achieve the best possible protective effect of

the seat belts when used properly and with the correct seat settings.

The two outer seat belt buckles of the rear seats are intended for the persons sitting on the left and right.

The center seat belt buckle of the rear seats is intended for the person sitting in the middle.

## Safety information

### **WARNING**

Use of a seat belt to buckle more than one person will potentially defeat the ability of the seat belt to serve its protective function. There is a risk of injury and danger to life. Do not strap in more than one person per single seat belt. Infants and children are not allowed on an occupant's lap, and must be transported and secured in designated child restraint systems.

### **WARNING**

The protective effect of safety gear, including seat belts, can be limited or lost when seat belts are fastened incorrectly. An incorrectly fastened seat belt can cause additional injuries, for instance in the event of an accident, braking or evasive maneuvers. There is a risk of injury and danger to life. Make sure that all occupants are wearing seat belts correctly.

### **WARNING**

With a rear seat backrest that is not locked, the protective effect of the middle seat belt is not guaranteed. There is a risk of injury and danger to life. If you are using the middle seat belt, lock the wider rear seat backrest.

### **WARNING**

The protective effect of safety gear, including seat belts, may not be fully operational or fail in the following situations:

- ▷ The seat belts or seat belt buckles are damaged, soiled, or changed in any other way.
- ▷ Seat belt tensioners or seat belt winders were modified.

Seat belts can be imperceptibly damaged in the event of an accident. There is a risk of injury and danger to life. Keep clean and do not modify: seat belts, seat belt buckles, seat belt tensioners, seat belt winders, and seat belt anchors. After an accident, have the seat belts checked by an authorized service center or another qualified service center or repair shop.

## Correct use of seat belts

To use the seat belts correctly, note the following:

- ▷ Wear the seat belt so that it fits tightly to your body over your pelvis and shoulder and is not twisted.
- ▷ Wear the seat belt low down on your hips in the pelvic region. The seat belt must not press on your stomach.
- ▷ Do not rub the seat belt against sharp edges, or guide it or jam it in across hard or fragile objects.
- ▷ Avoid thick clothing.
- ▷ Re-tighten the seat belt frequently upward in your upper body area.

## Fastening the seat belt

1. To fasten the seat belt, guide the seat belt slowly over the shoulder and pelvis.
2. Insert the buckle tongue into the seat belt buckle. The seat belt buckle must engage audibly.

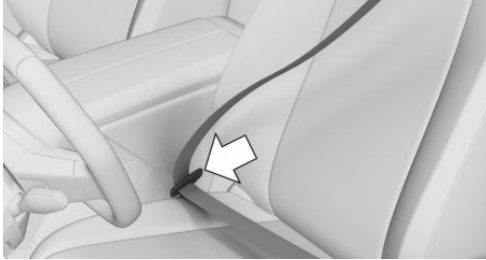

To ease accessibility to the seat belt buckle, an adjustable slider is available on the belt to help position the buckle when not in use.

## Unfastening the seat belt

1. To unfasten the seat belt, hold the seat belt firmly.
2. Press the red button on the seat belt buckle.
3. Guide the seat belt back into the seat belt winder.

## Seat belt reminder

### Principle

The Seat Belt Warning warns the driver if the seat belts are not fastened.

### General information





The seat belt reminder becomes active in the following situations:

- ▶ When the seat belt on the driver's side or on the passenger's side is not fastened.
- ▶ When the seat belt is unfastened while driving.
- ▶ When objects are lying on a seat.

## Display in the instrument cluster

The indicator light in the instrument cluster illuminates after turning on the drive-ready state when the seat belt reminder is active.

If a Check Control message appears, check whether the seat belt is fastened correctly.

Icon	Meaning
	Seat belt on the driver's seat is not buckled.
	Seat belt on the passenger seat or another seat in the vehicle is not buckled.
	Seat belt is buckled on the corresponding seat.
	Seat belt is not buckled on the corresponding seat.

## Rear Occupant Alert

### Principle

At the end of the drive, the Rear Occupant Alert informs the driver that occupants may be present on the rear seats.

### General information

If a door with access to the rear seat row is operated within 30 minutes before starting a drive, a notice appears on the control display and a signal tone sounds at the end of the drive.

If the drive is continued within 30 minutes, the notice is displayed again after the drive is complete.

## Activating/deactivating the Rear Occupant Alert

1. To enable/disable the Rear Occupant Alert, go through the menu as follows: Apps menu / "Vehicle" / "Rear Occupant Alert".
2. Select the desired setting.

## Front head restraints

### Safety information

#### WARNING

The lack of protective effect due to removal or incorrect adjustment of head restraints can cause injuries in the head and neck area. There is a risk of injury.

- ▷ Before driving, install the removed head restraints on the occupied seats.
- ▷ If possible, adjust the head restraint so that the center of the head restraint supports the back of the head at eye level.
- ▷ Adjust the distance so that the head restraint is as close as possible to the back of the head. Adjust the distance via the backrest tilt as needed.
- ▷ For manually adjustable head restraints: After adjusting, make sure that the head restraint is correctly engaged.

#### WARNING

Body parts can be jammed when moving the head restraint. There is a risk of injury. Make sure that the area of movement is clear when moving the head restraint.

#### WARNING

Objects on the head restraint reduce the protective effect in the head and neck area. There is a risk of injury.

- ▷ Do not use seat or head restraint covers.
- ▷ Do not hang objects, for instance clothes hangers, directly on the head restraint.
- ▷ Only use accessories that have been determined to be safe for attachment to a head restraint.
- ▷ Do not use any accessories, for instance pillows, while driving.

### Adjusting the height

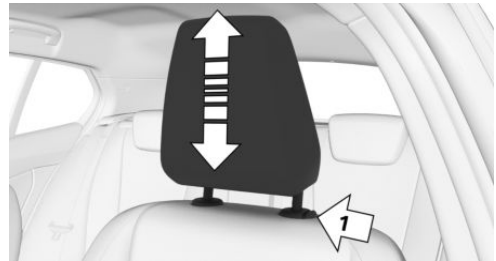

- ▷ To lower the head restraint, press the release button on the backrest, then push the head restraint downward, arrow 1.
- ▷ To raise the head restraint, push the head restraint upward.

### Adjusting the height: M sport seat

The height of the head restraints cannot be set.

### Adjusting the distance

The backrest tilt is used to set the distance between the head restraint and the back of the seat occupant's head.

Adjust the distance so that the head restraint is as close as possible to the back of the head.

### Removing/attaching head restraints

Only remove the head restraint if no one will be sitting in the seat in question.

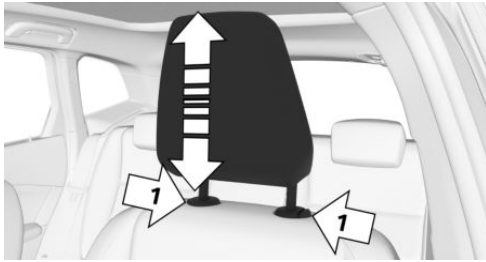

1. Raise the head restraint to the resistance point.
2. Press both release buttons on the backrest simultaneously, then pull the head restraint completely out, arrows 1.

Proceed in the reverse order to install the head restraint.

## Removing the head restraints: M Sport seat

The head restraints cannot be removed.

## Rear head restraints

### Safety information

#### WARNING

The lack of protective effect due to removal or incorrect adjustment of head restraints can cause injuries in the head and neck area. There is a risk of injury.

- ▷ Before driving, install the removed head restraints on the occupied seats.
- ▷ If possible, adjust the head restraint so that the center of the head restraint supports the back of the head at eye level.

- ▷ Adjust the distance so that the head restraint is as close as possible to the back of the head. Adjust the distance via the backrest tilt as needed.
- ▷ For manually adjustable head restraints: After adjusting, make sure that the head restraint is correctly engaged.

#### WARNING

Body parts can be jammed when moving the head restraint. There is a risk of injury. Make sure that the area of movement is clear when moving the head restraint.

#### WARNING

Objects on the head restraint reduce the protective effect in the head and neck area. There is a risk of injury.

- ▷ Do not use seat or head restraint covers.
- ▷ Do not hang objects, for instance clothes hangers, directly on the head restraint.
- ▷ Only use accessories that have been determined to be safe for attachment to a head restraint.
- ▷ Do not use any accessories, for instance pillows, while driving.

## Folding down the head restraints

### Principle

To improve the view to the rear, the head restraints can be folded back. Only fold the head restraint back if no one will be sitting in the seat in question.

## Folding the head restraint



Press the button and fold the head restraint back, arrow 1.

To return the head restraint to its initial position, fold the head restraint forward as far as it will go until it engages.

## Exterior mirrors

### Principle

Exterior mirror settings are saved to the active BMW ID or driver profile. If the BMW ID or driver profile is reactivated later, the saved position is brought up automatically.

Depending on vehicle equipment, the driver's side exterior mirror also dims automatically. Photocells in the interior mirror are used to control this.

Depending on vehicle equipment, both exterior mirrors are heated automatically as necessary and when drive-ready state is on.

### General information

The front passenger's side exterior mirror is more curved than the driver's side mirror.

The current exterior mirror adjustment can be stored using the memory function.

## Safety information

### WARNING

Objects in the mirror are closer than they appear. The distance to the road users behind could be incorrectly estimated, for instance while changing lanes. There is a risk of accident, injury, and property damage. Estimate the distance to the traffic behind by looking over your shoulder.

## Overview



Icon	Meaning
	Fold the exterior mirrors in and out.
	Adjust the exterior mirrors.
	Select left exterior mirror. Automatic Curb Monitor.
	Select right exterior mirror.



Fold the exterior mirrors in and out.



Adjust the exterior mirrors.



Select left exterior mirror. Automatic Curb Monitor.





Select right exterior mirror.

## Selecting/adjusting the exterior mirrors

- ▶  To select the left exterior mirror, press the corresponding button on

the driver's door. The LED illuminates.

- ▶  To select the right exterior mirror, press the corresponding button on the driver's door. The LED illuminates.

- ▶  On the driver's door, press the button for adjusting the exterior mirrors.

The selected exterior mirror moves along with the button movement.

## Malfunction

In case of an electrical malfunction, adjust the exterior mirror by pressing on the edges of the mirror glass.

## Folding in/folding out the exterior mirrors

### NOTICE

Depending on the vehicle width, the vehicle can be damaged in car washes. There is a risk of property damage. Before washing, fold in the mirrors by hand or with the button.

- ▶  To fold the exterior mirrors in/out, press the button for folding the exterior mirrors in/out on the driver's door.

Folding is possible up to a speed of approx. 15 mph/20 km/h.

Folding the exterior mirrors in and out is helpful in the following situations:

- ▶ In car washes.
- ▶ On narrow roads.

Exterior mirrors that were folded in are folded out automatically at a speed of approx. 25 mph/40 km/h.

## Automatic heating

Both exterior mirrors are automatically heated as needed and when the drive-ready state is switched on.

## Automatic dimming

The exterior mirror on the driver's side is automatically dimmed. Photocells in the interior mirror are used to control this.

## Automatic Curb Monitor

### Principle

If reverse gear is engaged, the mirror glass on the passenger's side is tilted downward. Tilting the mirror glass downward improves the driver's view of the curb or other ground-level obstacles, e.g., when pulling into a parking space.

### Activating the Automatic Curb Monitor

1.  To activate the Automatic Curb Monitor, press the exterior mirror button on the driver's door. The LED illuminates.
2. Engage selector lever position R.

### Deactivating the Automatic Curb Monitor

- ▶  To deactivate the Automatic Curb Monitor, press the exterior mirror button on the front passenger door. The LED illuminates and the LED of the driver's side outside mirror goes out.

## Interior mirror, manually dimmable



To reduce blinding glare from the interior mirror, tilt the lever forward on the manually dimming interior mirror.

## Interior mirror, automatic dimming feature

### Principle

The interior mirror is dimmed automatically. Photocells in the mirror glass and on the rear of the mirror are used to control glare.

### Overview



## Functional requirements

To have the interior mirror dim automatically, the following functional requirements must be met:

- ▷ Keep the photocells clean.
- ▷ Do not cover the area between the interior mirror and the windshield.

## Steering wheel

### Safety information

#### **WARNING**

Steering wheel adjustments while driving can lead to unexpected steering wheel movements. There is a risk of accident, injury, and property damage. Adjust the steering wheel while the vehicle is stationary only.

### Manual steering wheel adjustment

The position of the steering wheel can be changed by manually adjusting the height and longitudinal direction.

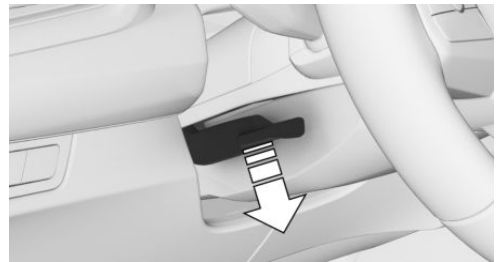

1. On the steering column, press the release lever all the way down.
2. Grip the steering wheel with both hands and move the steering wheel to a height and angle that suits the seat position.
3. Flip the lever back again.

## Memory function

### Principle

The following settings can be stored and, if necessary, retrieved using the memory function:

- ▷ Seat position.
- ▷ Exterior mirror adjustment.
- ▷ Lumbar support position.
- ▷ Height of the Head-up display.

### Safety information

#### WARNING

Using the memory function while driving can lead to unexpected seat or steering wheel movements. There is a risk of accident, injury, and property damage. Only retrieve the memory function when the vehicle is stationary.

#### WARNING

There is a danger of jamming when moving the seats. There is a risk of injury and risk of property damage. Make sure that the travel path of the seat is clear prior to any adjustment.

### Overview



The memory buttons are located on the driver's door.

### Storing settings

To save settings to memory using the buttons, proceed as follows:

1. Set the desired position.
2.  Press the SET button on the driver's door. The LED illuminates.
3. Press memory button 1 or 2 while the LED is illuminated. A successful save is indicated by a signal tone.

To save settings to memory via iDrive, proceed as follows:

1. Go through the menu as follows: Apps menu / "Vehicle" / "Seat comfort".
2. Select the desired seat position.
3. Tap the icon for the SET button.

### Calling up settings

To access settings saved to memory using the buttons, proceed as follows:

Press memory button 1 or 2.

The stored position is called up.

The procedure stops when a seat setting switch or one of the memory buttons is pressed again.

The adjustment of the seat position on the driver's side is interrupted after a short time while driving.

1. To bring up the settings in the memory function via iDrive, go through the menu as follows via iDrive: Apps menu / "Vehicle" / "Seat comfort".
2. Select the desired seat.
3. Select the desired seat position.

# Transporting children safely

## Vehicle features and options

This chapter describes model-specific equipment, systems, and functions that are currently available, or may become available in the future, even if they are not present in the vehicle.

Additional information:

Vehicle equipment, refer to page 8.

## The right place for children

### Safety information

#### **WARNING**

Unattended children or animals in the vehicle can cause the vehicle to move and endanger themselves and traffic, for example, due to the following actions:

- ▷ Establishing standby.
- ▷ Releasing the parking brake.
- ▷ Opening and closing the doors or windows.
- ▷ Engaging selector lever position N.
- ▷ Using vehicle equipment.

There is a risk of accident, injury, and property damage. Do not leave children or animals unattended in the vehicle. Take the vehicle key with you when exiting and lock the vehicle.

#### **WARNING**

A hot vehicle may result in death to persons, especially children, or animals. There is a risk of injury and danger to life. Do not leave people, especially children, or animals unattended in the vehicle.

#### **WARNING**

Exposure to intense sunlight can cause child restraint systems and their components to become very hot. Persons may sustain burn injuries when touching the hot components. There is a risk of injury. Do not expose the child restraint system to direct sunlight or cover where necessary. If necessary, let the child restraint system cool down before transporting a child. Do not leave children unattended in the vehicle.

## Children in the rear seat

### General information

Accident research shows that the safest place for children is in the rear seat.

Children younger than 13 years of age or shorter than 5 ft/150 cm should be transported in the rear seat in suitable child restraint systems designed for the age, weight and size of the child. Children 13 years of age or older must wear a seat belt as soon as a suitable child restraint system can no longer be used due to their age, weight, or size.

## Safety information

### **WARNING**

The seat belt cannot be fastened correctly on children shorter than 5 ft/150 cm without suitable additional child restraint systems. The protective effect of safety gear, including seat belts, can be limited or lost when seat belts are fastened incorrectly. An incorrectly fastened seat belt can cause additional injuries, for instance in the event of an accident, braking or evasive maneuvers. There is a risk of injury and danger to life. Secure children shorter than 5 ft/150 cm using suitable child restraint systems.

## Children on the front passenger seat

### General information

When using a child restraint system on the front-passenger seat, observe the respective national and local regulations.

When using a child restraint system on the front passenger seat, make sure that the front passenger airbag is deactivated.

Additional information:

Automatic deactivation of front passenger air-bag, refer to page [166](#).

### Safety information

### **WARNING**

If activated, the front passenger airbag can injure children seated in a child restraint systems when deployed. There is a risk of injury. Make sure that the front passenger airbag is deactivated and that the PASSENGER AIR-BAG OFF indicator light is illuminated.

## Installing child restraint systems

### General information

When selecting, installing, and using child restraint systems, follow the operating and safety instructions provided by the child restraint system manufacturer.

The vehicle is equipped with three-point seat belts on all seats. All compatible child restraint systems can be secured with a seat belt.

Declaration according to FMVSS 210, Seat belt assembly anchorages: Child restraint systems are designed to be secured in vehicle seats by lap belts or the lap belt portion of a lap-shoulder belt.

### Safety information

### **WARNING**

Child restraint systems may provide limited protection in the following situations:

- ▷ The child restraint systems are not installed correctly.
- ▷ Children are not properly secured by a child restraint system.

There is a risk of injury and danger to life. Make sure that child restraint systems are installed correctly in the vehicle and that children are properly secured by the child restraint system.

### **WARNING**

The protective effect of child restraint systems and their fastening systems which have been damaged or exposed to an accident can be limited or lost. A child cannot be properly restrained in the event of an accident, braking or evasive maneuvers. There is a risk of injury and danger to life.

Do not use child restraint systems which have been damaged or exposed to an accident.

If attachment systems have been damaged or strained by an accident, have them checked and replaced by an authorized service center or another qualified service center or repair shop.

### **WARNING**

The stability of the child restraint system is limited or compromised with incorrect seat setting or improper installation of the child seat. There is a risk of injury and danger to life. Make sure that the child restraint system fits securely against the backrest. If possible, adjust the backrest tilt for all affected backrests and correctly adjust the seats. Make sure that seats and backrests are securely engaged or locked. If possible and necessary, adjust the height of the head restraints or remove them.

## Before installation

Before installing child restraint systems, ensure that the rear seat backrests are locked.

Move the rear seats into the rearmost position to facilitate installation of the child restraint system.

## On the front passenger seat

### Deactivating the airbag

### **WARNING**

If activated, the front passenger airbag can injure children seated in a child restraint systems when deployed. There is a risk of injury. Make sure that the front passenger airbag is deactivated and that the PASSENGER AIRBAG OFF indicator light is illuminated.

After mounting a child restraint system on the front passenger seat, make sure that the front passenger airbag is deactivated.

Additional information:

Automatic deactivation of front passenger airbag, refer to page 166.

### Seat position and height

After installing a child restraint system, move the front passenger seat as far back as it will go and, if possible, to the highest position. This seat position and height ensure the best possible position for the belt and offers optimal protection in the event of an accident.

After installing a universal child restraint system, adjust the backrest tilt to achieve the best possible belt routing.

If the upper attachment point of the seat belt is located in front of the seat belt guide of the child seat, move the front passenger seat carefully forward until the best possible seat belt guide position is reached.

### Backrest width

Adjustable backrest width: before installing a child restraint system on the front passenger seat, open the backrest width completely. Do not change the backrest width again and do not call up a memory position.

## Child seat security

### General information



To secure child restraint systems, the rear seat belts and front passenger seat belt can be locked to prevent them from being pulled out.

### Locking the seat belt

1. Pull out the seat belt strap completely.
2. Secure the child restraint system with the seat belt.
3. Allow the seat belt strap to retract, then pull it tight against the child restraint system. The seat belt is locked.

### Unlocking the seat belt

1. Open the seat belt buckle.
2. Remove the child restraint system.
3. Allow the seat belt strap to retract completely.

In some cases it may be necessary to separate the lower belt attachment. Safety belts, refer to page [100](#).

## Lower anchors for child restraint systems

### Principle

LATCH child restraint systems establish a secure connection to the vehicle in combination with LATCH anchors.

## General information

LATCH: Lower Anchors and Tether for Children.

When selecting, installing, and using child restraint systems, follow the operating and safety instructions provided by the child restraint system manufacturer.

### Mounts for lower anchors

#### General information

The lower anchors may be used to attach the CRS to the vehicle seat up to a combined child and CRS weight of 65 lbs/30 kg when the child is restrained by the internal harnesses.

### Safety information



#### **WARNING**

If the lower anchors on child restraint system are not engaged correctly, the child restraint system will not be able to provide suitable protection. There is a risk of injury and danger to life. Make sure that the lower anchors are correctly engaged and that the child restraint system fits securely against the backrest.

#### **WARNING**

The mounts for the lower anchors and attachment points of the child restraint system are intended for attaching child restraint systems only. If other objects are attached, the mounts or attachment points can be damaged. There is a risk of injury and risk of property damage. Only attach child restraint systems at the corresponding mounts for the lower anchors or attachment points.

## Position

Icon	Meaning
	The corresponding icon shows the mounts for the lower LATCH anchors.
	Seats equipped with lower anchors are marked with a pair (2) of LATCH icons. For vehicles equipped with a middle seat: It is not recommended to use the inner lower anchors of standard outer LATCH positions to secure a child restraint system on the middle seat. Use the vehicle seat belt instead for the middle seat.

## Before installing child restraint systems

Before installing a child restraint system, pull the seat belt away from the area of the lower anchors of the child restraint system.

## Installing child restraint systems

To install the child restraint system in the vehicle, proceed as follows:

1. Mount the child restraint system in accordance with the instructions from the child seat manufacturer.
2. Make sure that the child restraint system anchors engage correctly on both sides in the lower seat mounts.

## Child restraint systems with tether strap

### General information

When attaching child restraint systems to the upper attachment points, observe the speci-

cations and the operating and safety information of the child restraint system manufacturer.

## Safety information

### WARNING

If the upper retaining strap is incorrectly used for the child restraint system, the protective effect is reduced. There is a risk of injury. Ensure that the upper retaining strap is guided to the upper attachment point without twisting and not over sharp edges.



### WARNING

If the rear seat backrest is not locked, the protective effect of the child restraint system is limited or nonexistent. In certain situations, for instance braking maneuvers or in case of an accident, the rear seat backrest can fold forward. There is a risk of injury and danger to life. Make sure that the rear seat backrests are locked.

### WARNING

The mounts for the lower anchors and attachment points of the child restraint system are intended for attaching child restraint systems only. If other objects are attached, the mounts or attachment points can be damaged. There is a risk of injury and risk of property damage. Only attach child restraint systems at the corresponding mounts for the lower anchors or attachment points.

## Attachment points for upper retaining strap

Icon	Meaning
 	<p>The respective icon shows the attachment point for the upper retaining strap. Seats with an upper top tether are marked with this icon. It is located on the rear seat backrest, the rear shelf or the rear seat.</p>

## Routing the retaining strap

### Rear seat

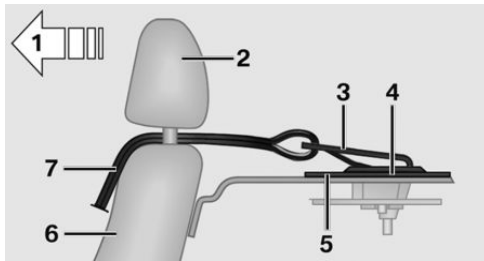

- 1 Driving direction
- 2 Head restraint
- 3 Hook for upper retaining strap
- 4 Attachment point
- 5 Rear shelf
- 6 Seat backrest
- 7 Upper retaining strap

## Attaching the upper retaining strap to the attachment point

### Rear seat

To attach the upper strap to the attachment point, proceed as follows:

1. Open the attachment point cover.
2. Raise the head restraint.

3. Guide the upper strap between the head restraint rods, or along both sides of the head restraint rods, to the attachment point.

Center seat: Guide the upper strap between the head restraint rods, or along both sides of the head restraint rods, to the attachment point.

4. Attach the hook of the retaining strap to the attachment point.
5. Tighten the retaining strap.

## Locking the doors and windows in the rear

### Principle

To prevent the rear doors and windows from being opened from inside the vehicle, there is a switch on the corresponding rear door frame or a safety switch on the driver's door armrest.



### General information

In certain situations it may be advisable to secure the rear doors and windows, for instance when transporting children.

### Doors



To secure the rear doors, release/lock the safety switch on the rear door using the integrated key.

Icon	Meaning
	Child safety lock.
	Apply the child safety lock.

The door can now be opened from the outside only.

After locking, make sure that the door cannot be opened from the inside.

## Safety switch for the rear

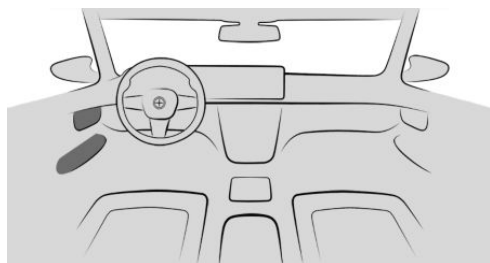

 The safety switch for the rear is located on the driver's door.

 To lock rear functions, press the safety switch in the driver's door. The LED is illuminated when the safety function is turned on.

Various functions are locked and cannot be operated in the rear such as the power windows.

# Driving

## Vehicle features and options

This chapter describes model-specific equipment, systems, and functions that are currently available, or may become available in the future, even if they are not present in the vehicle.

Additional information:

Vehicle equipment, refer to page 8.

## Start/Stop button

### Principle

The Start/Stop button is used to turn vehicle operating states on/off.

### Overview

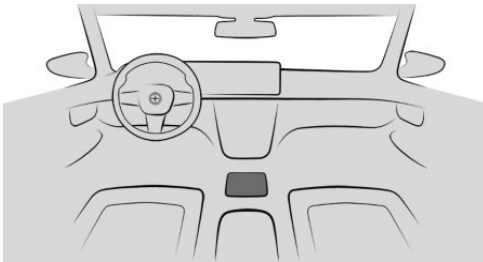

The Start/Stop button is located on the center console.

### Turning on the drive-ready state

Drive-ready state turns on when the brake pedal is pressed while pushing the Start/Stop button.

Pushing the Start/Stop button again will turn off drive-ready state and turn on standby state.

Additional information:

- ▶ Drive-ready state, refer to page 41.
- ▶ Standby state, refer to page 41.

### Driving off

To drive off with the vehicle, proceed as follows:

1. Depress the brake pedal.
2. Press the Start/Stop button.  
Drive-ready state is turned on.
3. Engage the desired selector lever position, e.g., D or R.
4. To drive off, release the brake pedal and press the accelerator pedal.

The parking brake releases automatically when the desired selector lever position is engaged.

## Auto Start/Stop function

### Principle

The Auto Start/Stop function helps save fuel. The system switches off the engine during a stop, for instance in traffic jam or at traffic lights. Drive-ready state remains on despite the engine being stopped. The engine starts automatically for driving off.

The Auto Start/Stop function switches to standby whenever the engine is started using the Start/Stop button.

The function is activated at low speeds.

### Engine stop

### Functional requirements

When stopping, the engine switches off automatically if the following requirements are met:

- ▷ Selector lever is in selector lever position D.
- ▷ The brake pedal remains depressed while the vehicle is at a standstill, or the vehicle is held by Automatic Hold.
- ▷ The driver's seat belt is buckled, or the driver's door is closed.

## Manual engine stop

If the engine does not shut off automatically when the vehicle is stopped, the engine can be shut off manually as follows:

- ▷ By quickly depressing the brake pedal from its current position.
- ▷ By engaging selector lever position P.

When all functional preconditions are fulfilled, the engine switches off.

## Air conditioning system when the engine is switched off

The air flow from the air conditioning system is reduced when the engine is switched off.

## Display in the instrument cluster



The READY indicator on the instrument cluster shows that the Auto Start/Stop function is ready to start the engine automatically.

## Functional limitations

The engine does not switch off automatically in situations like the following:

- ▷ In case of a steep downhill grade.
- ▷ If the brake pedal is not depressed firmly enough.
- ▷ When the outside temperature is high and the air conditioning system is on.
- ▷ If the vehicle interior has not been heated or cooled as desired.
- ▷ When there is heavy window condensation and the air conditioning system is on.

- ▷ If the engine or other parts are not at normal operating temperature.
- ▷ If the engine must be cooled.
- ▷ With a sharp wheel angle or strong steering on vehicles without mild hybrid technology.
- ▷ When the vehicle battery is deeply discharged
- ▷ At higher elevations.
- ▷ When the hood is unlocked.
- ▷ When Hill Descent Control is activated.
- ▷ For stop-and-go traffic.
- ▷ When the selector lever position is S, L, or R.
- ▷ After reversing.
- ▷ If a traffic situation is detected that is likely to have a very short stop time, e.g., stopping at a stop sign.

## Starting the engine

### Functional requirements

When driving off, the engine starts automatically if the following requirements are met:

- ▷ By releasing the brake pedal.
- ▷ If the accelerator pedal is pressed when Automatic Hold is activated.
- ▷ By the driver assistance systems activated, depending on vehicle equipment and driving situation.

### Driving off with the Auto Start/Stop function

To drive off, accelerate normally after starting the engine.

### Safety mode

If one of the following conditions is met, the engine will not start automatically after it has been stopped automatically:

- ▷ The driver's seat belt is unbuckled, and the driver's door is open.
- ▷ The hood has been unlocked.

Some indicator lights illuminate for a varied length of time.

The engine can only be started using the Start/Stop button.

## System limits

Even if driving off was not intended, the deactivated engine starts up automatically in the following situations:

- ▷ With excessive warming of the interior when cooling is turned on.
- ▷ With excessive cooling of the interior when heating is turned on.
- ▷ When there is heavy window condensation and the air conditioning system is on.
- ▷ With a sharp wheel angle or strong steering on vehicles without mild hybrid technology.
- ▷ When changing the selector lever position from D or P to R.
- ▷ If the vehicle battery is deeply discharged.
- ▷ When starting an oil level measurement.

## Deactivating Auto Start/Stop manually

### Principle

In certain driving situations, e.g., traffic jams, it may be helpful to deactivate Auto Start/Stop manually. The engine will then no longer switch off automatically.

If this function is deactivated while the engine is being stopped automatically, the engine will start.

### Via selector lever position or drive mode

The Auto Start/Stop function is deactivated in the following situations:

- ▷ When selector lever position S is engaged.
- ▷ When selector lever position L is engaged.
- ▷ If SPORT or SPORT PLUS driving mode is selected in My Modes.

### Via iDrive

The Auto Start/Stop function can also be disabled via iDrive.

1. To do so, go through the menu as follows: Apps menu / "Vehicle" / "Driving settings" / "Drivetrain and chassis" / "Auto Start/Stop".
2. Select the desired setting.

Depending on vehicle equipment, e.g., on vehicles with a diesel engine and mild hybrid technology, the Auto Start/Stop function cannot be disabled via iDrive.

### Switching off the vehicle during an automatic engine stop

If the engine stops automatically, the vehicle can be parked safely as follows, e.g., to exit it.

1. Press the Start/Stop button.
  - ▷ Drive-ready state is switched off.
  - ▷ Standby state is switched on.
  - ▷ Selector lever position P is engaged automatically.
2. Engage the parking brake.

### Automatic deactivation

In certain situations, the Auto Start/Stop function is deactivated automatically for safety reasons, for instance if no driver is detected.

### Malfunction

Auto Start/Stop no longer switches off the combustion engine automatically in the event of a malfunction. A Check Control message is displayed on the instrument cluster. You may continue driving. Have the vehicle checked by

an authorized service center or another qualified service center or repair shop.

## Automatic transmission

### Principle

The automatic transmission automatically shifts all gears for driving forward. Shift paddles allow you to shift manually as necessary.

### Safety information

#### WARNING

An unsecured vehicle can begin to move and possibly roll away. There is a risk of accident, injury, and property damage. Before leaving your vehicle, secure it against rolling away, e.g., by applying the parking brake.

### Selector lever positions

#### Gear position D

In selector lever position D, all gears for forward travel are shifted automatically.

The vehicle drives off slowly when the brake pedal is released.

Additional information:

Automatic Hold, refer to page [129](#).

#### With shift paddles: S for SPORT program

Selector lever position S is the gear position used for sportier driving.

The vehicle drives off slowly when the brake pedal is released.

#### R reverse gear

To reverse, engage selector lever position R. Only engage reverse gear when the vehicle is stationary.

The vehicle drives off slowly when the brake pedal is released.

#### N Neutral

To push the vehicle or have it coast without using engine power, engage selector lever position N, e.g., in a car wash.

#### Without shift paddles: L for LOW mode

In selector lever position L, the transmission continues to shift automatically, but generally with lower gears.

The vehicle drives off slowly when the brake pedal is released.

### Parking lock, P

#### General information

In selector lever position P, the drive is blocked by the transmission, e.g., to park the vehicle.

#### P is engaged automatically

Selector lever position P engages automatically in situations like the following:

- ▶ After drive-ready state is switched off, if selector lever position R, D, S, or L is engaged.
- ▶ After standby state is switched off, if selector lever position N is engaged.
- ▶ If the driver's seat belt is unbuckled and the driver's door is opened while the vehicle is stationary and selector lever position R, N, D, S, or L is engaged.

The vehicle may begin to move if selector lever position P is not engaged and the parking brake is not applied before leaving the vehicle.

Additional information:

Parking brake, refer to page [127](#).

## Engaging selector lever positions

### General information

The vehicle moves when a gear position is engaged or in reverse gear if the brake pedal is not depressed when driving off.

In certain situations, e.g., to rock free on snow, it is possible to shift between reverse gear and gear position D without depressing the brake.

### Functional requirements

The selector lever will only change from position P to another selector lever position if drive-ready state is on and the brake pedal is depressed.

Selection lever position P cannot be disengaged until all technical prerequisites are met.

### Engaging a selector lever position

To engage the selector lever position, proceed as follows:

1. Fasten the driver's seat belt.
2. Tilt or pull the selector lever in the desired direction, past the resistance point as necessary. The selector lever automatically returns to the center position when released.

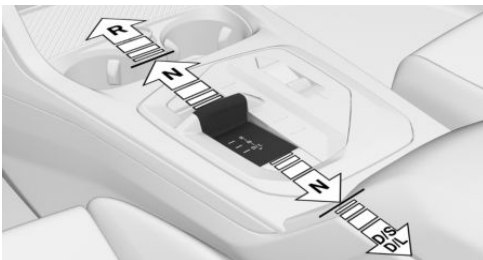

## Engaging selector lever position P



 To engage selector lever position P, press the parking brake button on the center console.

The parking brake is applied and the parking lock is engaged.

## Rolling or pushing the vehicle

### Principle

In some situations, the vehicle is supposed to coast for a short distance without using engine power, e.g., in a car wash or when pushing the vehicle.

## Engaging selector lever position N

### NOTICE

Selector lever position P is automatically engaged when standby state is switched off. The wheels are blocked. There is a risk of property damage. Do not switch off standby if the vehicle is meant to coast, e.g., in a car wash.

To engage selector lever position N, proceed as follows:

1. Depress and hold the brake pedal.
2. Switch on drive-ready state.
3. If necessary, loosen the belt.
4. If necessary, open the door.

5. Engage selector lever position N.
6. Switch off drive-ready state.

In this way, standby state remains switched on, and a Check Control message is displayed.

The vehicle can roll.

The parking lock engages automatically after approx. 35 minutes.

If the system is not operational, you may not be able to change the selector lever position.

If necessary, release the parking lock electronically.

Additional information:

Releasing the parking lock electronically, refer to page 123.

## Kickdown

The maximum driving performance is achieved with kickdown.

Step on the accelerator pedal beyond the resistance point at the full throttle position.

## Without shift paddles: LOW mode

### Principle

LOW mode is recommended to increase the engine braking effect, e.g., on steep downhill gradients.

### General information

In LOW mode, the transmission continues shifting automatically, but generally in lower gears than in selector lever position D.

LOW mode can therefore also be used to accelerate more quickly.

## Enabling LOW mode



To activate LOW mode, pull the selector lever from selector lever position D to D/L.

The engaged gear is displayed in the instrument cluster, for instance L1.

The transmission's LOW mode is enabled.

## Exiting LOW mode

To exit LOW mode, pull the selector lever to D/L.

D is displayed in the instrument cluster.

## With shift paddles: S program

### Principle

The S program's shift points and shift times are designed for sportier handling. The transmission shifts up later, for example, and the shift times are shorter, depending on vehicle equipment.

## Activating the Sport program



To activate the Sport program, pull the selector lever from selector lever position D to D/S.

The engaged gear is displayed in the instrument cluster, for instance S1.

The sport program of the transmission is activated.

## Ending the Sport program

To cancel the Sport program, move the selector lever to D/S.

D is displayed in the instrument cluster.

## Displays in the instrument cluster

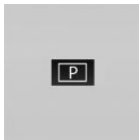

The selector lever position, for example, P, is shown on the instrument cluster.

## Releasing the parking lock electronically

### General information

To maneuver the vehicle out of a hazardous area, release the parking lock electronically.

Before releasing the parking lock, secure the vehicle to prevent it from rolling away, e.g., using a wheel chock.

### Engaging selector lever position N

To engage selector lever position N, proceed as follows:

1. Depress the Start/Stop button three times in quick succession without pressing the brake pedal.
2. Depress and hold the brake pedal.
3. Within 30 seconds, push the selector lever into position N until position N is shown on the selector lever.

An appropriate Check Control message is displayed.

4. Maneuver the vehicle from the hazardous area and secure it against rolling away.

## Shift paddles

### Principle

The shift paddles on the steering wheel are used to change gears manually.

### General information

#### Shifting

The vehicle only shifts at suitable RPM and road speeds.

Even in manual mode, the transmission shifts automatically in certain situations, e.g., when speed limits are reached.

#### Temporary manual mode

In selector lever position D, pulling a shift paddle switches into manual mode temporarily.

The engaged gear is also displayed in the instrument cluster, for instance D1.

After conservative driving in manual mode without acceleration or shifting via the shift paddles for a certain amount of time, the transmission switches back to automatic mode.

It is possible to switch into automatic mode:

- ▶ Pull and hold the right shift paddle until D is displayed in the instrument cluster.
- ▶ In addition to the pulled right shift paddle, pull the left shift paddle.

#### Continuous manual mode

In Sport program S, pulling a shift paddle switches to manual mode M.

The engaged gear is displayed in the instrument cluster, e.g., M1.

It is possible to switch into automatic mode:

- ▷ Pull and hold the right shift paddle until S is displayed on the instrument cluster.
- ▷ In addition to the pulled right shift paddle, pull the left shift paddle.
- ▷ Pull the selector lever to D/S.

If M2 is set manually when the vehicle is stationary, the transmission no longer shifts down to M1.

## Shifting



- ▷ To upshift, pull the right shift paddle.
- ▷ To downshift, pull the left shift paddle.

The selected gear is shown briefly on the instrument cluster, then the current gear is shown again.

## Advanced mode

### General information

Depending on vehicle equipment, the automatic transmission offers an advanced mode with adapted shift characteristics.

- ▷ This avoids automatic downshifting to the lowest possible gear.
 

In manual mode, the automatic transmission does not shift to the lowest possible gear during kickdown.
- ▷ Automatic upshifting is prevented in manual mode.
 

In manual mode, the automatic transmission does not shift up automatically when reaching a rev limit.

## Enabling advanced mode

Advanced mode turns on in the following situations, for example:

- ▷ The transmission is in manual mode.
- ▷ "SPORT PLUS": Settings for drive system in Sport Mode from My Modes.

## Launch Control

### Principle

Launch Control ensures optimum acceleration on roads with good traction and with dry ambient conditions.

### General information

Using Launch Control causes premature component wear since this function represents a very heavy load for the vehicle.

Depending on vehicle equipment, increased drive power is provided when driving off with Launch Control.

Do not turn the steering wheel when driving off with Launch Control.

Do not use Launch Control when braking in the vehicle.

Additional information:

Break-in, refer to page [302](#).

### Functional requirement

Launch Control can be used when the engine is at operating temperature. The engine is at operating temperature after an uninterrupted trip of at least 6 miles/10 km.

### Driving off with Launch Control

To drive off with Launch Control, proceed as follows:

1. Switch on drive-ready state.
2. Engage forward gear.

3.  Press the My Modes button on the center console.
4. Enable the driving dynamics setting: "SPORT PLUS".
5. Depress and hold the brake pedal with the left foot.
6. Press and hold the accelerator pedal.  
Launch Control information is displayed in the instrument cluster.
7. The starting engine speed adjusts. Wait briefly until the engine speed is constant. Keep the accelerator pedal in this position.
8. Release the brake pedal within a few seconds of the Launch Control information illuminating.  
The vehicle accelerates.  
Upshifting is performed automatically.  
Launch Control stays on as long as the Launch Control information is displayed and the accelerator pedal is not released.

Additional information:

Setting for increased driving dynamics, refer to page [210](#).

## Repeated use during a trip

After Launch Control has been used, the transmission must cool down for a short time before Launch Control can be used again. Launch Control adjusts to the surrounding conditions when used again.

## After using Launch Control

To support driving stability, reactivate Dynamic Stability Control as soon as possible.

## Sport Boost function

### Principle

The Sport Boost function can be used for upcoming acceleration, for example.

This function is operated with the shift paddles on the steering wheel.

The system prepares the vehicle.

### Overview



The shift paddles are located on the steering wheel.

### Display in the instrument cluster

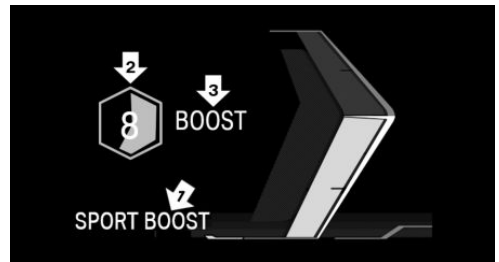

- ▶ Arrow 1: the Sport Boost function is activated.
- ▶ Arrow 2: countdown, the Sport Boost function is activated.
- ▶ Arrow 3: the Sport Boost function is used for maximum acceleration.

## Using the Sport Boost function

1. Pull the left shift paddle until the following indicator appears on the instrument cluster, arrow 1: SPORT BOOST. A countdown is displayed, arrow 2.
2. Before the countdown changes to 0, press the accelerator pedal.
  - ▷ The vehicle accelerates.
  - ▷ BOOST: this display is shown on the instrument cluster, arrow 3.

The countdown can be restarted, for example if the function cannot be used immediately.

To restart the countdown, pull and hold the left shift paddle again until the countdown is reset.

## Stopping the function

The Sport Boost function stops automatically once the countdown has reached 0 or if the function was used for acceleration.

## Deactivating the function

Pull and hold the right shift paddle until the following indicator disappears: SPORT BOOST.

## My Modes

### Principle

My Modes are used to adjust vehicle handling and customize the overall experience in the interior.

The vehicle can be adapted depending on the situation using the various My Modes.

Depending on vehicle equipment, the following systems are affected, for example:

- ▷ Drive system.
- ▷ Steering.
- ▷ Suspension.
- ▷ Cruise Control.
- ▷ Display on the instrument cluster.

- ▷ Comfort functions in vehicle interior.
- ▷ BMW IconicSounds.

## Overview

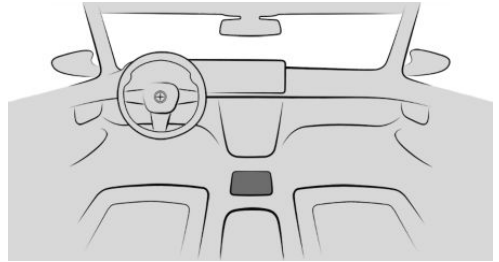

My Modes button on the center console.

## Displays in the instrument cluster



If applicable, the driving mode selected is displayed on the instrument cluster.

## My Modes in detail

### General information

Various My Modes are available depending on vehicle equipment.

Some My Modes affect the vehicle's handling characteristics and are therefore also referred to as drive modes.

### Personal Mode

Personal Mode is a drive mode that provides comfort-related settings.

### Sport Mode

Sport Mode is a drive mode that provides increased vehicle agility.

Individual settings, e.g., for the driving dynamics, chassis, and drive system, can be configured as needed.

"SPORT PLUS": under Driving Dynamics, this setting activates increased driving dynamics and limits driving stabilization.

Additional information:

- ▶ Dynamic Stability Control, refer to page 208.
- ▶ Setting for increased driving dynamics, refer to page 210.

## Efficient Mode

Efficient Mode is a drive mode that provides consumption-optimized tuning and an anticipatory display.

Additional information:

- ▶ Efficient mode, refer to page 309.

## More My Modes

Depending on the vehicle equipment, more My Modes are available that change the ambiance in the vehicle interior:

- ▶ Expressive Mode.
- ▶ Digital Art Mode.
- ▶ Relax Mode.
- ▶ Silent Mode.

## Selecting My Modes





1.  To select My Modes, press the My Modes button on the center console.
2. Select the desired mode.

## Configuring My Modes

Some My Modes can be configured individually.





1.  To adjust My Modes, press the My Modes button on the center console.
2. Select the desired mode.
3.  Select the settings icon.
4. Select the desired settings.

## Changing the start mode

Some My Modes can be set as the start mode. The set start mode activates when drive-ready state is turned on.



1.  To set My Modes as the start mode, press the My Modes button on the center console.
2. Select the desired mode.
3.  Select the settings icon.
4. "Start mode"
5. Select the desired mode.

## Drive-off assistant

### Principle

On inclines, in selector lever position D, L, S, or R, the Drive-off Assistant prevents the vehicle from coasting opposite the set driving direction and also provides drive-off support.

### Driving off

Press the accelerator pedal to drive off.

Depending on the vehicle load or driving situation, the vehicle may roll back slightly.

If necessary, activate Automatic Hold and also apply the parking brake via iDrive, as applicable. The parking brake is released automatically when you drive off.

Additional information:

- ▶ Automatic Hold, refer to page 129.
- ▶ Parking brake, refer to page 127.

## Parking brake

### Principle

The parking brake is used to prevent the vehicle from rolling away when it is parked.

## Safety information

### WARNING

An unsecured vehicle can begin to move and possibly roll away. There is a risk of accident, injury, and property damage. Before leaving the vehicle, secure the vehicle against rolling away.

In order to ensure that the vehicle is secured against rolling away, follow the following:

- ▷ Set the parking brake.
- ▷ Make sure that selector lever position P is engaged.
- ▷ On uphill grades or on downhill slopes, turn the front wheels in the direction of the curb.
- ▷ On uphill grades or on downhill slopes, also secure the vehicle, for instance with a wheel chock.

### WARNING

Unattended children or animals in the vehicle can cause the vehicle to move and endanger themselves and traffic, for example, due to the following actions:

- ▷ Establishing standby.
- ▷ Releasing the parking brake.
- ▷ Opening and closing the doors or windows.
- ▷ Engaging selector lever position N.
- ▷ Using vehicle equipment.

There is a risk of accident, injury, and property damage. Do not leave children or animals unattended in the vehicle. Take the vehicle key with you when exiting and lock the vehicle.

## Overview

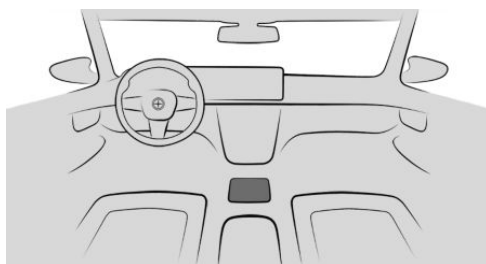

 The parking brake button is located on the center console.

## Setting the parking brake

### With a stationary vehicle

 To engage the parking brake, press the parking brake button on the center console.

The LED illuminates.

 The indicator light for the parking brake illuminates red.

The parking brake is applied and parking lock is engaged.

### While driving

Using the parking brake while driving serves as emergency braking.

 To brake the vehicle, press and hold the parking brake button on the center console. The vehicle brakes hard for as long as the button is pressed.

 The indicator light for the parking brake illuminates red, a signal sounds, and the brake lights illuminate.

A Check Control message is displayed.

The parking brake is applied and the parking lock engaged when the vehicle is stationary.

## Engaging the parking brake automatically

In some situations, the parking brake is engaged automatically, e.g., through Automatic Hold.

1. To automatically engage the parking brake when drive-ready state is deactivated, go through the menu as follows: Apps menu / "Vehicle" / "Driving settings" / "Drivetrain and chassis" / "Apply parking brake".
2. Select the desired setting.

In selector lever position N, the parking brake does not engage automatically.

## Releasing the parking brake

### Releasing the parking brake manually

To release the parking brake manually, proceed as follows:

1. Switch on drive-ready state.

2.  Press the parking brake button on the center console while pressing the brake pedal.

The LED and the indicator light go out. The parking brake is released.

The parking lock remains engaged until a gear position is selected.

### Releasing the parking brake automatically

The parking brake releases automatically in the following situations:

- ▶ When switching from selector lever position P to another selector lever position.
- ▶ When driving off.

The LED and the indicator light go out.

### Using the parking brake via iDrive

The parking brake can be engaged or disengaged via iDrive. When the parking brake is

operated via iDrive, the current selector lever position remains engaged. Additionally, further information is displayed.

1. To operate the parking brake via iDrive, go through the menu as follows: Apps menu / "Vehicle" / "Driving settings" / "Drivetrain and chassis" / "Apply parking brake".
2. Select the desired setting.

## Malfunction

A Check Control message appears if the parking brake malfunctions or fails. Before leaving the vehicle, secure it against rolling away, e.g., with a wheel chock.

### After a power interruption

To reestablish parking brake operability after a power interruption, an initialization may be required.

1. Activate standby state.

2.  Press the parking brake button on the center console.

3.  Press the parking brake button again after 2 seconds.

The Check Control messages for the parking brake go out.

Function-related noises are normal.

-  The indicator light for the parking brake indicates that the parking brake is ready for operation again.

## Automatic Hold

### Principle

Automatic Hold provides assistance by automatically applying and releasing the brake, e.g., when driving off on inclines or in stop-and-go traffic.

When a gear position is engaged, the vehicle is automatically held in place when it is stationary.

In selector lever position N, Automatic Hold is temporarily deactivated.

## Safety information

### WARNING

An unsecured vehicle can begin to move and possibly roll away. There is a risk of accident, injury, and property damage. Before leaving the vehicle, secure the vehicle against rolling away.

In order to ensure that the vehicle is secured against rolling away, follow the following:

- ▷ Set the parking brake.
- ▷ Make sure that selector lever position P is engaged.
- ▷ On uphill grades or on downhill slopes, turn the front wheels in the direction of the curb.
- ▷ On uphill grades or on downhill slopes, also secure the vehicle, for instance with a wheel chock.

### WARNING

Unattended children or animals in the vehicle can cause the vehicle to move and endanger themselves and traffic, for example, due to the following actions:

- ▷ Establishing standby.
- ▷ Releasing the parking brake.
- ▷ Opening and closing the doors or windows.
- ▷ Engaging selector lever position N.
- ▷ Using vehicle equipment.

There is a risk of accident, injury, and property damage. Do not leave children or animals unattended in the vehicle. Take the vehicle key with you when exiting and lock the vehicle.

## Functional requirements

Drive-ready state must be turned on in order to activate/deactivate Automatic Hold.

## Activating Automatic Hold

### Via iDrive

To activate Automatic Hold, go through the menu as follows: Apps menu / "Vehicle" / "Driving settings" / "Drivetrain and chassis" / "Automatic Hold".



When Automatic Hold is activated, the indicator light for the parking brake illuminates green.



When driving, the indicator light changes from green to gray to show that Automatic Hold is ready.

## Using the brake pedal

To activate Automatic Hold using the brake pedal, the vehicle must be at a standstill.

1. Depress the brake pedal until some resistance is perceptible.
2. Then depress the brake pedal firmly.



As soon as Automatic Hold is activated, the indicator light for the parking brake illuminates green and a Check Control message appears.



When driving, the indicator light changes from green to gray to show that Automatic Hold is ready.

## Automatic Hold holding the vehicle

If Automatic Hold is activated and the driver's door is closed, the vehicle is automatically secured to prevent it from rolling away after stopping.



As soon as Automatic Hold secures the vehicle to prevent it from rolling away, the indicator light for the parking brake illuminates green.

Your foot can be taken off the brake pedal.

## Automatic parking brake application

If the vehicle is being held by Automatic Hold, the parking brake is applied automatically in the following situations:

- ▷ If the parking brake is used to brake the vehicle to a stop while driving.
- ▷ The driver's door is open for more than one second and no pedal is pressed during this time.
- ▷ If drive-ready state is turned off.



The indicator light for the parking brake changes from green to red.

The parking brake is not set automatically if the drive-ready state was switched off while the vehicle was coasting. Automatic Hold is temporarily deactivated in this case.

## Driving off

Press the accelerator pedal to drive off.

The brake is released automatically and the indicator light of the parking brake is no longer illuminated.

The vehicle may roll back slightly when driving off, depending on the load.

Drive off quickly to prevent the vehicle from rolling backward when driving off.

If necessary, also apply the parking brake via iDrive. The parking brake is released automatically when you drive off.

Additional information:

Parking brake, refer to page 127.

## Deactivate Automatic Hold

### Via iDrive

To activate/deactivate Automatic Hold via iDrive, go through the menu as follows: Apps menu / "Vehicle" / "Driving settings" / "Drivetrain and chassis" / "Automatic Hold".

The indicator light for the parking brake goes out.

If the vehicle is being held by Automatic Hold, also press the brake pedal when deactivating.

### Deactivating via the brake pedal

To deactivate Automatic Hold using the brake pedal, the vehicle must be at a standstill.

1. Depress the brake pedal until some resistance is perceptible.
2. Then depress the brake pedal firmly.

The indicator light for the parking brake goes out and a Check Control message appears.

Automatic Hold is deactivated.

# Displays

## Vehicle features and options

This chapter describes model-specific equipment, systems, and functions that are currently available, or may become available in the future, even if they are not present in the vehicle.

Additional information:

Vehicle equipment, refer to page 8.

## Live Vehicle

### Principle

Live Vehicle is a virtual representation of your vehicle with different information, e.g., vehicle status or current driving condition.

Corresponding information is shown on the control display depending on the driving situation. Fault statuses are not taken into account. Adaptive content or various static content can be selected.

### Adaptive content

The following content is displayed in alternating order and, if necessary, depending on the selected drive mode:

- ▷ Vehicle status, refer to page 149.
- ▷ Current driving condition, refer to page 149.
- ▷ Sport displays, refer to page 149.
- ▷ Efficiency trainer, refer to page 310.
- ▷ Trip data, refer to page 146.
- ▷ Depending on vehicle equipment: Terrain View.







### Static information

The following information may be shown permanently on the control display regardless of the driving situation and driving mode set.

- ▷ Vehicle status.
- ▷ Trip data.
- ▷ Depending on vehicle equipment: Terrain View.

### Terrain View

Depending on vehicle equipment, the following information is shown in Terrain View, for example:

Icon	Description
	Specified longitudinal inclination.
	Specified lateral inclination.
	Specified height for current position.
	Self-leveling suspension.
	Steering angle.
	With all-wheel drive: distribution of drive torque to wheels.

### Adjusting the display

The Live Vehicle menu provides the option to choose between adaptive or static content on the left-hand side bar.

1. To adjust the display, go through the menu as follows: Apps menu / "Vehicle" / "Live Vehicle".
2. Select the desired setting.

## BMW Head-up display

### Principle

The Head-up display projects important information in the driver's field of view, for instance the speed. The driver can then view informa-

tion on the Head-up display without taking their eyes off the road.

The steering wheel buttons can be used to configure various views for the Head-up display. Additional settings can be made on the control display, e.g., brightness or height.

## General information

Follow instructions for cleaning the Head-up display in the Vehicle Care chapter.

Additional information:

Caring for special components, refer to page 374.

## Overview

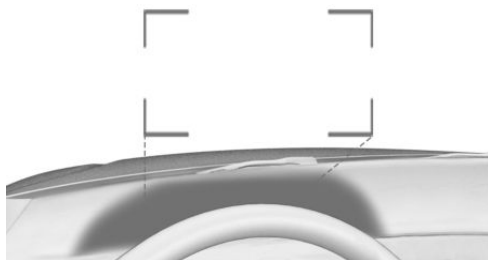

Head-up display views are projected onto the windshield through a protective glass. The protective glass is located between the steering wheel and windshield.

## Displayable information

The following information is displayed on the Head-up display:

- ▶ Speed.
- ▶ Navigation instructions.
- ▶ Check Control messages.
- ▶ Sport displays.
- ▶ Shift lights.
- ▶ The Efficiency Coach.
- ▶ Lists and messages.
- ▶ The driver assistance systems.
- ▶ Curve Ahead view.

Some of this information is only displayed briefly as needed.

## Configuring a view

Views can be configured for the Head-up display independently of the view on the instrument cluster, e.g., reduced view.



1. Press the Settings button on the steering wheel.  
A menu bar is displayed in the instrument cluster.
2. "HEAD-UP"  
Select the menu by tilting the thumbwheel on the steering wheel where applicable.
3. Select the desired setting using the thumbwheel on the steering wheel.

## Turning the Head-up display on/off

To turn the Head-up display on/off, go through the menu as follows: Apps menu / "Vehicle" / "Displays" / "Head-up display" / "Head-up display".

In addition, the Head-up display can also be turned on/off via quick access:

1. Swipe from top to bottom on the control display.
2. "Head-up display"

## Settings

Various settings can be configured for the Head-up display, e.g., height, rotation, or brightness. You can also set up specific views on the Head-up display separately, e.g., for Driver Assistance information.

1. Go through the menu as follows: Apps menu / "Vehicle" / "Displays" / "Head-up display".
2. Select the desired setting.

Depending on vehicle equipment, the height of the Head-up display can be stored using the memory function.

## Visibility of the display

The visibility of the displays in the Head-up display is influenced by the following factors:

- ▷ Seat position.
- ▷ Objects on the Head-up display's protective glass.
- ▷ Dust or dirt on the Head-up display's protective glass.
- ▷ Windshield dirty on inside or outside.
- ▷ Sunglasses with certain polarization filters.
- ▷ Wet road.
- ▷ Unfavorable light conditions.

If the image is distorted, have the basic settings checked by an authorized service center or another qualified service center or repair shop.

## Special windshield

The special windshield is part of the Head-up display system.

The shape and coating of the special windshield enable this system to function.

If damaged, have the special windshield replaced by an authorized service center or another qualified service center or repair shop.

## Check Control

### Principle

The Check Control system monitors functions in the vehicle and notifies you of faults in the monitored systems.

A Check Control message is displayed as a combination of indicator lights or warning lights and text messages on the instrument cluster and, if applicable, on the Head-up display. In addition, an acoustic signal may sound

and a text message may appear on the control display.

Some Check Control messages are hidden automatically after approx. 20 seconds, but they will be stored. Stored Check Control messages can be displayed on the control display. Urgent Check Control messages are permanently displayed but may be hidden temporarily.

## Hiding Check Control messages

Permanently displayed Check Control messages can be hidden temporarily. These messages are automatically displayed again after approx. 8 seconds.

◀ An arrow icon next to the Check Control message indicates whether the Check Control message can be hidden.



To hide Check Control messages, tilt the thumbwheel on the steering wheel to the left.

## Displaying stored Check Control messages

Saved Check Control messages and additional information such as the cause of a fault or the required action can be called up via Check Control.

Depending on the Check Control message, further help can be selected.

1. Go through the menu as follows: Apps menu / "Vehicle" / "Vehicle status" / "Check Control".
2. Select the desired text message.

### Display

A Check Control message is displayed in the instrument cluster as a text message with an icon.

For urgent messages, an added text is automatically displayed on the control display. If several faults occur at once, the messages are displayed consecutively.

Certain messages displayed while driving are displayed again after drive-ready state is switched off.



Icons in the instrument cluster indicate an active or saved Check Control message.



## Indicator lights and warning lights

### Principle

The indicator lights and warning lights show the status of some vehicle functions or indicate when there is a fault in monitored systems.

Indicator lights and warning lights can illuminate in a variety of combinations and colors.

Some indicator lights are checked for proper functioning and illuminate temporarily when drive-ready state is turned on.

### Red lights

#### Seat belt reminder



Seat belt on the driver's seat is not buckled.

Additional information:

Seat belt reminder, refer to page [102](#).

#### Airbag system



Warning light illuminates briefly: indicates that the entire airbag system and seat belt tensioners are operational when drive-ready state is switched on.

Warning light does not illuminate or illuminates continuously: The airbag system or seat belt tensioners may not be operational. Have the

vehicle checked immediately by an authorized service center or another qualified service center or repair shop.

Additional information:

Airbags, refer to page [164](#).

#### Parking brake



The parking brake is set.

Additional information:

Parking brake, refer to page [127](#).

#### Brake system



The brake pads are worn or there is another issue with the brake system.



The braking assistance may not be operational. A higher pedal force may be required for braking.

Have the vehicle checked immediately by an authorized service center or another qualified service center or repair shop.

#### Emergency Stop Assistant



The Emergency Stop Assistant is triggered.

Additional information:

Emergency Stop Assistant, refer to page [197](#).

#### Risk of collision



The warning light illuminates or flashes in conjunction with an acoustic signal if there is a risk of imminent collision.

Additional information:

Forward Collision Mitigation, refer to page [169](#).

#### Pedestrian Warning



Warning light illuminates: risk of collision with a person, e.g., a pedestrian or cyclist, detected. Increased awareness is required.

Warning light flashes and acoustic signal sounds: risk of imminent collision with a person, e.g., a pedestrian or cyclist, detected. Immediately initiate braking or an evasive maneuver.

Additional information:

Warning function for pedestrians, refer to page [176](#).

### Forward Collision Warning



Warning light illuminates: risk of collision, e.g., with a vehicle, detected. Increased awareness is required.

The warning light flashes and a signal sounds: risk of imminent collision with a vehicle detected. Immediately initiate braking or an evasive maneuver.

Additional information:

Warning function in rear-end collision situations, refer to page [172](#).

### Intersection Warning: vehicle detected from the right



The warning light illuminates: risk of collision with a vehicle crossing from the right detected. Increased awareness is required.

The warning light flashes and a signal sounds: risk of imminent collision with a crossing vehicle detected. Immediately initiate braking or an evasive maneuver.

Additional information:

Warning function at intersections, refer to page [178](#).

### Intersection Warning: vehicle detected from the left



The warning light illuminates: risk of collision with a vehicle crossing from the left detected. Increased awareness is required.

The warning light flashes and a signal sounds: risk of imminent collision with a crossing vehicle detected. Immediately initiate braking or an evasive maneuver.

Additional information:

Warning function at intersections, refer to page [178](#).

### Distance Control



Warning light flashes and acoustic signal sounds: Brake and evade as necessary.

Additional information:

Distance Control, refer to page [219](#).

### Assisted Driving Mode



Warning light flashes and acoustic signal sounds:

The system is switched off or will be interrupted very soon.

Warning light illuminates and acoustic signal sounds:

The driver's line of sight is not directed at the surrounding traffic. System interruption is imminent. The system reduces the speed to a standstill if applicable. It is possible that the system will not execute any supporting steering movements.

Keep an eye on the surrounding traffic.

Additional information:

Assisted Driving Mode, refer to page [225](#).

### Assisted Driving Mode: The driver's hands are not currently gripping the steering wheel



Warning light illuminates and acoustic signal sounds:

The driver's hands are not currently gripping the steering wheel or, depending on vehicle equipment and national-market version, the driver is not looking at the surrounding traffic. System interruption is imminent.

The system reduces the speed to a standstill if applicable.

It is possible that the system will not execute any supporting steering movements.

Immediately grasp the steering wheel with your hands and pay attention to the surrounding traffic.

Additional information:

Assisted Driving Mode, refer to page [225](#).

## Yellow lights

### Antilock Braking System



The system may not be operational. The Antilock Braking System is not available.



The ability to steer may be restricted during full braking.

Have the vehicle checked immediately by an authorized service center or another qualified service center or repair shop.

Additional information:

Antilock Braking System, refer to page [208](#).

### Assisted Driving Mode



Warning light illuminates and acoustic signal sounds: A system interruption is imminent.

Warning light flashes: A lane boundary has been crossed.

Additional information:

Assisted Driving Mode, refer to page [225](#).

### Assisted Driving Mode: The driver's hands are not currently gripping the steering wheel



Steering wheel icon illuminates yellow: The driver's hands are not currently gripping the steering wheel. The system is still active.

Grab the steering wheel with your hands.

Additional information:

Assisted Driving Mode, refer to page [225](#).

### Dynamic Stability Control



Warning light flashes: Dynamic Stability Control is regulating the driving and brake power. The vehicle is stabilized.

Reduce the vehicle speed and adjust your driving style to the road conditions.

Warning light illuminates: Dynamic Stability Control has malfunctioned or is initializing. Driving stabilization is restricted or has failed.

If the warning light illuminates continuously, have the vehicle checked immediately by an authorized service center or another qualified service center or repair shop.

Additional information:

Dynamic Stability Control, refer to page [208](#).

### Dynamic Stability Control deactivated, or increased driving dynamics activated



Dynamic Stability Control is deactivated or enhanced driving dynamics is activated.

Additional information:

- ▷ Dynamic Stability Control, refer to page [208](#).
- ▷ Setting for increased driving dynamics, refer to page [210](#).

### Drive-off support



Drive-off support is activated.

Additional information:

Drive-off support, refer to page [211](#).

### Flat tire monitor



Warning light illuminates: flat tire or tire pressure loss has been detected.

Reduce your speed and stop cautiously. Avoid sudden braking and steering maneuvers.

Additional information:

Flat tire monitor, refer to page [335](#).

### Tire Pressure Monitor



Warning light illuminates: flat tire or tire pressure loss has been detected. Follow the information in the Check Control message.

Warning light flashes then illuminates continuously: flat tires or tire pressure losses cannot be detected.

- ▷ Fault caused by systems or devices with the same radio frequency: after leaving the area of the interference, the system automatically becomes active again.
- ▷ In the case of tires with special approval: the Tire Pressure Monitor was unable to complete the reset. Reset the system again.
- ▷ Wheel without wheel electronics installed: have it checked by an authorized service center or another qualified service center or repair shop as needed.
- ▷ Malfunction: have the vehicle checked by an authorized service center or another qualified service center or repair shop.

Additional information:

Tire Pressure Monitor, refer to page [328](#).

### Steering system



The steering system may not be operational.

Have the vehicle checked by an authorized service center or another qualified service center or repair shop.

### Pollutant emissions



- ▷ The warning light illuminates:  
The exhaust gas quality is declining, e.g., because the fuel filler cap is fitted incorrectly.
- ▷ The warning light flashes under certain circumstances:  
This indicates that there is excessive misfiring in the engine.  
Reduce the vehicle speed and have the system checked immediately by an authorized service center or another qualified service center or repair shop. Otherwise, severe engine misfires will very quickly cause serious damage to emissions-related components, especially the catalytic converter.

Have the vehicle checked by an authorized service center or another qualified service center or repair shop.

Additional information:

Diagnostic socket, refer to page [358](#).

### Green lights

#### Turn signal



- The turn signal is turned on.  
If the indicator light is flashing unusually fast, this indicates that a turn signal bulb has failed.

Additional information:

Turn signal, refer to page [151](#).

#### Parking lights



- The parking lights are turned on.  
Additional information:

Parking lights, low-beam headlights, refer to page [155](#).

### Low-beam headlights



The low-beam headlights are turned on.

Additional information:

Parking lights, low-beam headlights, refer to page [155](#).

### High Beam Assistant



Low-beam headlights are turned on, and the High Beam Assistant is activated.

The high-beam headlights are turned on and off automatically depending on the traffic.

Additional information:

High Beam Assistant, refer to page [152](#).

### Lane Departure Warning



Depending on vehicle equipment and national-market version:

Indicator light flashes: System is actively issuing a warning. If necessary, the system performs a steering intervention.

Additional information:

Lane Departure Warning, refer to page [183](#).

### Automatic Hold holding the vehicle



Automatic Hold secures the stopped vehicle to prevent it from rolling away, e.g., when stopped at a traffic light.

Additional information:

Automatic Hold, refer to page [129](#).

### Hill Descent Control decelerates the vehicle



The system is active. The vehicle is braked.

Additional information:

Hill Descent Control, refer to page [211](#).

### Cruise Control



The system is active.

Additional information:

Cruise Control, refer to page [217](#).

### Distance Control



Indicator light illuminates: a vehicle has been detected ahead of you. The vehicle icon goes out if no vehicle has been detected ahead of you.

Indicator light flashes: preceding vehicle has driven off.

Additional information:

Distance Control, refer to page [219](#).

### Speed Limit Assistant



The detected speed limit can be applied with the SET button. As soon as the speed limit has been applied, a green checkmark is displayed.

Additional information:

Speed Limit Assistant, refer to page [234](#).

### Assisted Driving Mode



The system supports the driver in keeping the vehicle within the lane.

Additional information:

Assisted Driving Mode, refer to page [225](#).

### Lane Change Assistant: lane change in progress



Arrow icon for lane change green: the system carries out a lane change.

Additional information:

Lane Change Assistant, refer to page [229](#).

### Lane Change Assistant: lane change not possible



Gray line for lane boundary on corresponding side: the system has detected a desire to change lanes. It is not currently possible to change lanes.

Additional information:

Lane Change Assistant, refer to page [229](#).

### Assisted Driving Mode Plus



The system is active.

Additional information:

Assisted Driving Mode Plus, refer to page [232](#).

## Blue lights

### High-beam headlights



High-beam headlights have been turned on.

Additional information:

High-beam headlights, refer to page [151](#).

### Automatic High Beam Assistant



High-beam headlights have been turned on by the High Beam Assistant.

Additional information:

High Beam Assistant, refer to page [152](#).

## Gray lights

### Seat belt reminder



Seat belt on the passenger seat or another seat in the vehicle is not buckled.

Additional information:

Seat belts, refer to page [100](#).

### Automatic Hold on standby



When driving, the indicator light shows that Automatic Hold is ready.

Additional information:

Automatic Hold, refer to page [129](#).

### Hill Descent Control is in standby



The system is in standby mode or temporarily deactivated.

Additional information:

Hill Descent Control, refer to page [211](#).

### Distance Control



Indicator light flashes: the requirements to operate the system have not been met. The system was deactivated but applies the brakes until you actively resume control by pressing on the brake pedal or accelerator pedal.

Additional information:

Distance Control, refer to page [219](#).

### Assisted Driving Mode



The system is on standby and does not manipulate steering movements.

System activates automatically as soon as all function conditions are fulfilled.

Additional information:

Assisted Driving Mode, refer to page [225](#).

## White lights

### Cruise Control with Distance Control



No Distance Control because accelerator pedal is being pressed.

Additional information:

Distance Control, refer to page [219](#).

## Assisted Driving Mode Plus



The system can be used.

Additional information:

Assisted Driving Mode Plus, refer to page [232](#).

## Selection lists

### Principle

Selection lists are shown on the Head-up display or instrument cluster, depending on vehicle equipment and settings. Certain functions can be displayed and operated as necessary via the selection lists:

- ▷ Entertainment source.
- ▷ Current audio source.
- ▷ List of recent calls.

If necessary, the corresponding menu will open on the control display.

### Displaying and using the list

The selection lists can be displayed and operated using the operating elements on the steering wheel.

### Operating elements    Function



Change the entertainment source.

Pressing the button again will close the currently displayed list.



Show list of most recent telephone calls.



Turn the thumbwheel: display the list for currently selected entertainment source or scroll up or down in the list.

Tilt thumbwheel in corresponding direction: Move selection to left or right.

Press thumbwheel: confirm selection.

## Gear shift indicator

### Principle

The shift point indicator recommends the gear that best suits the current driving situation. Using the optimal gear supports an efficient driving style.

### General information

The gear shift indicator is active in manual mode M depending on vehicle equipment and national-market version.

### Displays

The instrument cluster provides information on upshifting, downshifting, and the gear engaged.

On vehicles without a gear shift indicator, the engaged gear is displayed.

**Example Description**

M3	In continuous manual mode M: Optimal gear is engaged.
D3	With shift paddles: temporary manual mode.
S3	With shift paddles: Sport program.
L3	Without shift paddles: LOW mode.
2•3	Shift information.

Additional information:

Shift paddles, refer to page 123.

## Power gauge

### Principle

The power gauge indicates the currently drawn drive power as a percentage.

### Enabling/disabling the power gauge

The power gauge or the tachometer is displayed depending on the selected drive mode or the individually configured layout.

## Display



Indicator for energy recovered, e.g., when decelerating, CHARGE, arrow 1.

Drive power in percent, POWER, arrow 2.

### Reduced drive power

The available drive power may be reduced due to certain factors. The power gauge is adjusted automatically.

In addition, the icons on the power gauge and tachometer indicate that the drive power is reduced.

Icon	Description
	Blue icon: cold drivetrain.
	White icon: increased drive system temperature, for instance due to sustained or high power demand when driving on mountain roads.
	Depending on vehicle equipment and national-market version: Drive power limitation defined via the BMW Digital Key.
	System-related functional limitation. A Check Control message is displayed in addition where applicable.

## Tachometer

### Principle

Always avoid engine speeds in the red warning field. In this range, the fuel supply is reduced to protect the engine.

### Activating/deactivating the tachometer

The tachometer is displayed depending on the selected drive mode or the individually configured layout.

The tachometer display changes depending on the selected driving mode.

### Reduced rotational speed range

The rotational speed range may be reduced due to certain factors, e.g., drive system is cold. The tachometer display is automatically adjusted depending on the available rotational speed range.

## Standby state and drive-ready state



OFF

If OFF is displayed in the instrument cluster, drive-ready state is switched off and standby state is switched on.



READY

If READY is displayed in the instrument cluster, the Auto Start/Stop function is ready to start the engine automatically.

Additional information:

- ▷ Operating state of the vehicle, refer to page [39](#).
- ▷ Auto Start/Stop function, refer to page [117](#).

## Range

### Principle

The range on the instrument cluster indicates the distance that can still be covered with the current available power.

The range is dynamic and can be reduced or increased due to the following factors:

- ▷ Driving style.
- ▷ Traffic conditions.
- ▷ Changing drive modes.
- ▷ Load.
- ▷ Weather conditions and terrain.
- ▷ Automatic climate control settings.
- ▷ After determination of a route through the navigation system depending on the route profile, route distance and selected speed.
- ▷ When exiting a route or recalculating a route.

### General information

With a low remaining range, a Check Control message is briefly displayed. A low remaining range means that engine functions cannot always be ensured for sporty driving, e.g., when cornering at speed.

The Check Control message appears continuously below a range of approx. 30 miles/50 km.

### Safety information

#### NOTICE

With a range below 30 miles/50 km, the engine may no longer have sufficient fuel. Engine functions are not ensured anymore. There is a risk of property damage. Refuel promptly.

## Display



Next to the fuel gauge on the instrument cluster, the arrow beside the fuel pump symbol indicates which side of the vehicle the fuel filler flap is on.

The current range is displayed as numerical value.

## Fuel gauge

The current fill level of the fuel tank is displayed.

Vehicle inclination may cause the display to vary.

An arrow next to the fuel pump icon in the instrument cluster indicates the vehicle side on which the fuel filler flap is located.

Additional information:

Refueling, refer to page 314.

## Indicator light in the instrument cluster



The yellow indicator light illuminates, once the fuel reserve is reached.

## Engine temperature

The engine temperature is displayed in the instrument cluster.



▶ If the engine is cold, the needle is in the blue temperature range, close to the limit position of the temperature display. WARM-UP is also displayed.

Drive at moderate RPM and vehicle speeds.

- ▶ At normal operating temperature, the needle is in the middle or in the left half of the temperature display.
- ▶ If the engine is hot, the needle is in the red temperature range. In addition, a Check Control message is displayed.

Additional information:

Coolant level, refer to page 354.

## Display

The engine temperature is displayed in the instrument cluster.

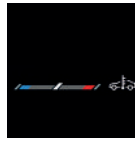

▶ If the engine is cold, the needle is in the blue temperature range, close to the left-hand limit position of the temperature display. WARM-UP is also displayed.

Drive at moderate RPM and vehicle speeds.

- ▶ At normal operating temperature, the needle is in the middle or in the left half of the temperature display.
- ▶ If the engine is hot, the needle is in the red temperature range. In addition, a Check Control message is displayed.

Additional information:

Coolant level, refer to page 354.

## Indicator light in the instrument cluster



A red indicator light is displayed.

## Outside temperature

### Principle

If the outside temperature indicator drops to +37°F/+3°C or lower, there is an increased risk of slippery conditions.

A signal sounds and a Check Control message is displayed.

When the vehicle is stationary or at low speed, the temperature displayed may differ slightly from the actual outside temperature due to external environmental influences.

### Safety information

#### WARNING

Even at temperatures above +37°F/+3°C there is a risk of icy roads, for instance on bridges or shady sections of the road. There is a risk of accident, injury, and property damage. Modify your driving style to the weather conditions at low temperatures.

## Shift lights

### Principle

Shift lights are temporarily displayed on the instrument cluster and indicate the correct time to upshift in order to achieve rapid acceleration.

The Shift lights are active in M Manual mode and can be shown on the instrument cluster or Head-up display in combination with the tachometer.

### Functional requirements

- ▶ Manual mode M must be activated.
- ▶ Advanced mode must be activated.

Additional information:

Advanced mode, refer to page [124](#).

## Display



Successive fields illuminating yellow indicate an upcoming shift point.

- ▶ Shift when all fields illuminate red at the latest.
- ▶ When the maximum rotational speed is reached, the entire display flashes red and the fuel supply is interrupted in order to protect the engine.

## Central display range

### Displayable content

In the central display area, the following settings can be selected:

- ▶ The reduced display.
- ▶ Trip data, refer to page [146](#).
- ▶ Assisted View, refer to page [147](#).
- ▶ With navigation system: route preview.
- ▶ With navigation system: map view.
- ▶ G-Meter, refer to page [148](#).
- ▶ The entertainment.
- ▶ Android Auto®.

Depending on vehicle equipment and national-market version, select functions of a compatible smartphone can also be displayed, e.g., map views.

Some contents for the central display range can also be configured as a view in the Head-up display.

Additional information:

Head-up display, refer to page 132.

Owner's Manual for Navigation, Entertainment, and Communication, refer to page 6.

## Configuring the central display range

The content of the central display range on the instrument cluster can be configured individually, for instance the trip data display.



1. Press the Settings button on the steering wheel.  
A menu bar is displayed in the instrument cluster.
2. "CONTENT"  
Select the menu by tilting the thumbwheel on the steering wheel where applicable.
3. Select the desired setting using the thumbwheel on the steering wheel.

## Trip data

### Principle

The trip data display provides various information about the trip, e.g., average consumption or trip distance.

The trip data can be displayed on the control display and in the instrument cluster.

Depending on the setting in the Live Vehicle menu, the trip data is shown on the control display.

The values can be displayed and reset depending on different intervals.

### Display on the control display

#### Displayable content

The following trip data is shown on the control display:

- ▷ Configured interval for trip data displays.
- ▷ The average fuel consumption depending on the configured interval.
- ▷ The travel time according to the set interval.
- ▷ The distance traveled depending on the configured interval.
- ▷ Depending on the vehicle equipment: the distance traveled in coasting mode.

### Displaying trip data continuously

To display trip data permanently, go through the menu as follows: Apps menu / "Vehicle" / "Live Vehicle" / "Adaptive content" / "Trip data".

### Display in the instrument cluster

Information on consumption and distance covered can be displayed in the instrument cluster display.

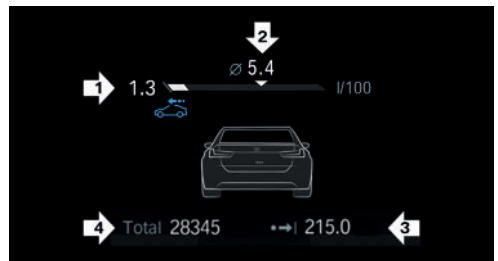

- ▷ Current consumption, arrow 1.
- ▷ Average consumption, arrow 2.
- ▷ Distance traveled depending on the configured interval, arrow 3.  
 Depending on vehicle equipment: an icon appears while coasting.
- ▷ Total mileage, arrow 4.

### Current consumption

The current fuel consumption display allows you to check the current fuel consumption, e.g., to drive economically and in an environmentally-friendly manner.

## Average consumption

The average fuel consumption is displayed in the instrument cluster depending on how the intervals for displaying trip data are configured.

## Adjusting the display of the trip data

The interval for displaying trip data on the instrument cluster and control display can be adjusted.

- Go through the menu as follows: Apps menu / "Vehicle" / "System settings" / "Time period for trip data" / "Values".
- Select the desired setting:
  - ▶ "Since start of trip": the values are automatically reset approx. four hours after the vehicle has come to a standstill.
  - ▶ "Since last refuel": the values are automatically reset after refueling with a larger quantity of fuel.
  - ▶ "Since factory": the values since the time of the factory delivery are displayed.
  - ▶ "Since Individual (I)": the values since the last manual reset are displayed. The values can be reset at any time.

## Resetting average values manually

The average trip data values can be reset manually. This resets the average values for the following interval: "since Individual".

Using the thumbwheel on the steering wheel:

- Press the button to display trip data on the instrument cluster.



- Press and hold the thumbwheel on the steering wheel until the values reset.

To reset the average values via iDrive, go through the menu as follows: Apps menu / "Vehicle" / "System settings" / "Time period for trip data" / "Reset Individual".

The average values and counters are reset. Once the average values and counters have been reset, the following interval is automatically activated: "since Individual".

## Assisted View

### Principle

With Assisted View, information on the driver assistance systems can be displayed on the instrument cluster with a vehicle image.

Parking and maneuvering information is displayed in the Assisted View whenever the parking assistance system is on.

### Safety information

#### **WARNING**

The system cannot serve as a substitute for the driver's personal judgment in assessing the traffic situation. Based on the limits of the system, it cannot independently react to all traffic situations. There is a risk of accident, injury, and property damage. Adjust driving style to traffic conditions. Watch the surrounding traffic situation closely, be ready to take over steering and braking at any time, and actively intervene where appropriate.

### General

You can configure how Assisted View is displayed on the central display range.

Additional information:

Central display area, refer to page [145](#).

## Display

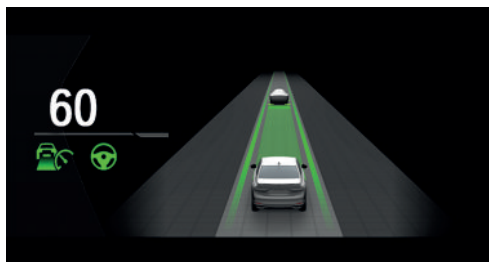

An example of active Driver Assistance: the indicator and warning lights for Distance Control and Assisted Driving Mode are displayed. At the same time, the Distance Control is animated in Assisted View.

## System limits

The detection capability of the Assisted View system is limited.

Only objects that are detected by the system are taken into account.

Additional information:

- ▷ Cameras, refer to page [34](#).
- ▷ Radar sensors, refer to page [35](#).

## G-Meter

### Principle

The G-Meter indicates the forces in the longitudinal and transverse direction to which the vehicle occupants are subjected while driving.

The display can be configured on the central display range of the instrument cluster.

The values are automatically reset whenever you start a new drive.

Additional information:

Central display area, refer to page [145](#).

## Manually resetting G-Meter values

1. Press the thumbwheel to display the G-Meter on the instrument cluster.



2. Press and hold the thumbwheel on the steering wheel until the values reset.

## Time and date

Various settings can be configured for displaying the date and time.

Depending on vehicle equipment and national-market version, the time zone can be set manually or automatically. Automatic time zone adjustment automatically updates the time, the date, and the time zone as necessary.

1. Go through the menu as follows: Apps menu / "Vehicle" / "System settings" / "Time".

The date is set automatically based on the time zone.

2. Select the desired setting.

## Setting the units of measurement

Depending on the national-market version, you can set the units of measurement for some values, for instance consumption, distances, and temperature.

1. Go through the menu as follows: Apps menu / "Vehicle" / "System settings" / "Units".

2. Select the desired setting.

## Vehicle status





### Principle

In the Vehicle status menu, the statuses can be displayed or actions performed for several systems such as for Check Control.

### Displaying vehicle status

To display the vehicle status, go through the menu as follows: Apps menu / "Vehicle" / "Vehicle status".

### Overview

Icon	Description
	"Flat tire monitor": Status of the flat tire monitor, refer to page <a href="#">335</a> .
	"Tire Pressure Monitor": status of the Tire Pressure Monitor, refer to page <a href="#">328</a> .
	"Engine oil level": electronic oil measurement, refer to page <a href="#">352</a> .
	"Check Control": displaying stored Check Control messages, refer to page <a href="#">134</a> .
	"Service": display of the service notifications, refer to page <a href="#">150</a> .

## Current driving condition

### Principle

The current driving condition is displayed dynamically while driving in the Live Vehicle menu on the control display.

The following states can be displayed:

- ▷ Driving.
- ▷ Coasting mode.
- ▷ Battery is charging.

Additional information:

- ▷ Coasting, refer to page [308](#).

### Functional requirements

To display the driving condition, the following functional requirements must be met:

- ▷ Personal Mode or Efficient Mode drive mode must be selected.
- ▷ With Live Vehicle, the following settings must be selected: "Adaptive content"

## Sport displays

### Principle

The sport displays in the Live Vehicle menu provide assistance for a sporty driving style.

### Functional requirements

To use the sport displays, the following functional requirements must be met:

- ▷ Sport drive mode must be selected.
- ▷ With Live Vehicle, the following settings must be selected: "Adaptive content".

### Display

The sport displays are displayed in the Live Vehicle menu on the control display.

The following information is displayed:

- ▷ The torque.
- ▷ The power.
- ▷ The boost pressure.
- ▷ The engine oil temperature.

# Service

---

## Principle

The service notifications indicate recommended maintenance work.

After turning on drive-ready state, the instrument cluster briefly displays the next service appointment or the distance remaining until the next recommended maintenance measures.

These can be read out from the vehicle key at an authorized service center.

## Display

More information may be displayed on the control display.

1. Go through the menu as follows: Apps menu / "Vehicle" / "Vehicle status" / "Service".

Maintenance work as well as possible legally mandated inspections are displayed.

2. Select the desired entry to bring up more information.

## Entering appointment dates

The dates for mandatory vehicle inspections can be entered.

Make sure that the vehicle's date and time are set correctly.

1. Go through the menu as follows: Apps menu / "Vehicle" / "Vehicle status" / "Service" / "Vehicle inspection".
2. Select the desired setting.

# Light and view

## Vehicle features and options

This chapter describes model-specific equipment, systems, and functions that are currently available, or may become available in the future, even if they are not present in the vehicle.

Additional information:

Vehicle equipment, refer to page 8.

## Turn signal

### Principle

The turn signal indicates the change in your direction of travel. To indicate a turn, the following functions can be used:

- ▷ Flashing.
- ▷ One-touch signaling.
- ▷ Brief flashing.

### Turn signal in exterior mirror

To ensure that the turn signal lights on the exterior mirrors are clearly visible, do not fold in the exterior mirrors while driving or while using the turn signals or hazard warning system.

### Flashing

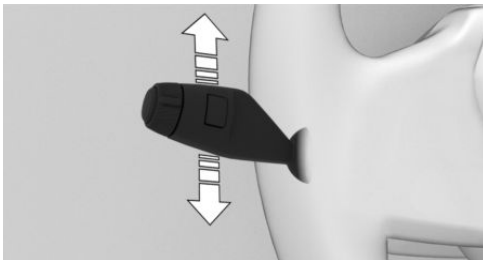

To flash the turn signal, push the turn signal lever up or down past the resistance point.

### One-touch signaling

For one-touch signaling: Lightly tap the turn signal lever up or down.

The one-touch signaling duration can be adjusted.

1. Go through the menu as follows: Apps menu / "Vehicle" / "Exterior lighting" / or "Settings" / "One-touch turn signal".
2. Select the desired setting.

### Brief flashing

To flash the turn signal briefly: push the turn signal lever to the resistance point and hold it there for as long as you wish to indicate a turn.

## High-beam headlights, headlight flasher

### Principle

The high-beam headlights illuminate the road, also at great distances. The headlight flasher is used to emit a brief light signal by actuating the high-beam headlights. The high-beam headlights can be switched on and off manually at any time.

## High-beam headlights, turning headlight flasher on/off

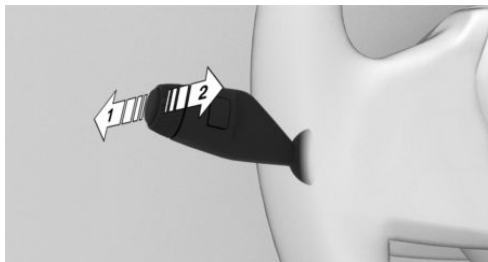

To turn on the high-beam headlights, push the turn signal lever forward, arrow 1. The high-beam headlights illuminate when the low-beam headlights are switched on.

To turn off the high-beam headlights or operate the headlight flasher, pull the turn signal lever backward, arrow 2.



The blue indicator light on the instrument cluster illuminates when the high-beam headlights are turned on or the headlight flasher is activated.

## High Beam Assistant

### Principle

The High Beam Assistant promptly detects other road users as well as the ambient lighting, e.g., in towns, and automatically switches the high-beam headlights on or off depending on the traffic situation.

You may need to activate the High Beam Assistant via iDrive before it can be used. You can use the turn signal lever to temporarily deactivate or activate the High Beam Assistant, e.g., after turning your high-beam headlights on/off manually.

## General information

In the low speed range, the high-beam headlights are not switched on by the High Beam Assistant.

## Functional requirements

To use the High Beam Assistant, the following functional requirements must be met:

- ▶ The automatic lights function is activated.
- ▶ The low-beam headlights are turned on.

## Activating High Beam Assistant

1. To activate the High Beam Assistant, go through the menu as follows: Apps menu / "Vehicle" / "Exterior lighting" / "Headlights".

2.  Tap the High Beam Assistant button.

The headlights are automatically changed between low-beam headlights and high-beam headlights.



The green indicator light on the instrument cluster illuminates when the low-beam headlights are turned on.



The blue indicator light in the instrument cluster illuminates when the system switches on the high-beam headlights.

If the Automatic High Beam Assistant is on and you continue driving after an interruption, the Automatic High Beam Assistant will remain on.

The Automatic High Beam Assistant is deactivated when the high-beam headlights are switched on and off manually.

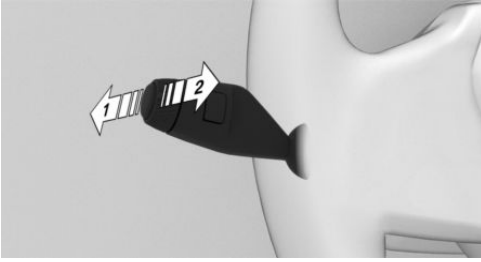

To reactivate the High Beam Assistant, press the turn signal lever up, arrow 1.

## Deactivating High Beam Assistant

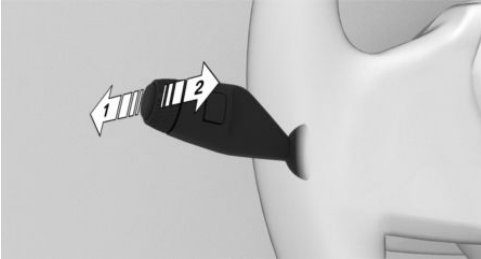

Press the turn signal lever forward, arrow 1, or pull the turn signal lever backward when the high-beam headlights are on, arrow 2.

When the High Beam Assistant is deactivated via iDrive, the operation with the turn signal lever is not possible.

## Sensitivity of the High Beam Assistant

### General information

The sensitivity of the High Beam Assistant can be adjusted.

## Safety information

### WARNING

If adjustments have been made or the sensitivity has been modified, oncoming traffic may be momentarily blinded. There is a risk of accident, injury, and property damage. If adjustments have been made and the sensitivity has been modified, make sure that oncoming traffic is not momentarily blinded. Turn off the high-beam headlights manually if required.

## Functional requirements

To adjust the sensitivity of the High Beam Assistant, the following functional requirements must be met:

- ▶ Adjustment is possible only while your vehicle is stationary.
- ▶ Drive-ready state is switched on.
- ▶ The light is switched off.
- ▶ For Canadian models: the parking lights are on.

## Increasing sensitivity

To increase the sensitivity of the High Beam Assistant, push the turn signal lever forward for approx. 10 seconds.

A Check Control message is displayed. The system responds more sensitively.

## Resetting the sensitivity

To reset the sensitivity of the High Beam Assistant, push the turn signal lever forward again for approx. 10 seconds or switch off drive-ready state.

The sensitivity of the High Beam Assistant is reset to the factory settings.

## System limits

The High Beam Assistant cannot replace the driver's personal judgment of when to use the high-beam headlights. Turn off the high-beam headlights manually in situations that require a personal decision.

The system may not be fully operational in the following situations, and driver intervention may be necessary:

- ▶ In very unfavorable weather conditions such as fog or heavy precipitation.
- ▶ When detecting poorly-lit road users such as pedestrians, cyclists, horseback riders and wagons; when driving close to train or ship traffic; or at animal crossings.
- ▶ In tight curves, on hilltops or in depressions, in crossing traffic or half-observed oncoming traffic on highways.
- ▶ In poorly-lit towns and cities or in the presence of highly reflective signs.
- ▶ When the windshield in the area in front of the interior mirror is fogged up, dirty or covered with stickers, etc.

## Exterior lighting

### Principle

The exterior lighting comprises all lighting elements on the outside of the vehicle. The exterior lighting, or individual functions of it, can be operated using the buttons in your vehicle, the buttons on your vehicle key, or via iDrive.



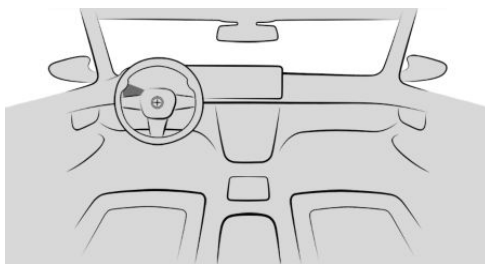

If the driver's door is opened when the drive-ready state is switched off, the exterior lighting is automatically switched off after a period of time.

## Overview



### Buttons in the vehicle







The exterior lighting switch and buttons are located on the turn signal lever, to the left of the steering wheel.



Icon	Function
	Exterior lighting menu.
	Low-beam headlights.
	Automatic headlight control.
	Exterior lighting off.

### Functions via iDrive

Icon	Function
	Automatic headlight control.
	Low-beam headlights.
	Exterior lighting off.

Icon	Function
	High Beam Assistant.
	Parking lights.
	Left roadside parking light.
	Right roadside parking light.

## Buttons on the vehicle key

Icon	Function
	Interior lighting. Parts of the exterior lighting.
	Pathway lighting.

## Driving lights automatic

### Principle

The automatic lights function switches the low-beam headlights on or off automatically depending on the ambient brightness, e.g., in tunnels, at dusk, or with precipitation.

### General information

A blue sky with the sun low on the horizon can cause the lights to be turned on.

The automatic lights function is deactivated if you turn on the low-beam headlights manually.

## Activate automatic headlight control

 To activate the automatic lights, turn the outer switch on the turn signal lever downward.

The LED under the automatic lights icon illuminates.

 The green indicator light on the instrument cluster illuminates when the low-beam headlights are turned on.

### System limits

The automatic headlight control cannot replace your personal judgment of lighting conditions.

For example, the sensors are unable to detect fog or hazy weather. In these situations, turn the lights on manually.

## Low-beam headlights, parking lights and roadside parking lights

### Principle

The low-beam headlights are used to illuminate the road without dazzling oncoming traffic. The parking lights and roadside parking lights are used to illuminate the vehicle when stationary. These functions can be operated using the buttons in the vehicle or via iDrive.

### Low-beam headlights

#### Turning on low-beam headlights

 To turn on the low-beam headlights, turn the outer switch on the turn signal lever upward.

The low-beam headlights illuminate when drive-ready state is switched on.



The green indicator light on the instrument cluster illuminates when the low-beam headlights are turned on.

To turn on the low-beam headlights even when standby state is switched on, turn the outer switch on the turn signal lever upward again.

## Turning off low-beam headlights

Depending on national-market version, the low-beam headlights can be turned off as follows at low speeds:

- ▶  Press the OFF button on the turn signal lever.
- ▶ Turn off the light via iDrive.

## Parking lights

### General information

The parking lights can only be turned on at low speeds.

### Turning on parking lights

1. To turn on the parking lights, go through the menu as follows: Apps menu / "Vehicle" / "Exterior lighting" / "Parking lights".
2.  Tap the parking lights button.



The green indicator light on the instrument cluster illuminates when the parking lights are turned on.

The vehicle is illuminated on all sides.

Do not use the parking lights for extended periods; otherwise, they might drain the vehicle battery and it would then be impossible to switch on drive-ready state.

### Turning off parking lights

The following options are available to turn off the parking lights:



- ▶ Press the OFF button on the turn signal lever.

- ▶ Turn off the light via iDrive.
- ▶ Switch on drive-ready state.

When drive-ready state is turned on, the automatic driving lights activate.

## Roadside parking lights

When the vehicle is parked, a one-sided roadside parking light can be switched on.

1. To turn on the roadside parking light, go through the menu as follows: Apps menu / "Vehicle" / "Exterior lighting" / "Parking lights".
2.  Tap the roadside parking light button for the desired side of the vehicle.

## Welcome lights

### Principle

The welcome light turns on automatically for a limited period of time when approaching or unlocking the vehicle.

Depending on the equipment, the exterior lighting of the vehicle can be set individually.

### Activating/deactivating welcome light

The welcome light can be activated or deactivated.

1. Go through the menu as follows: Apps menu / "Vehicle" / "Exterior lighting" / "Settings".
2. Select the desired setting, depending on vehicle equipment:
  - ▶ "Welcome and goodbye"
    - When unlocking the vehicle, individual lighting functions are turned on.
  - ▶ "BMW Iconic Glow"

You can configure the radiator grille lighting only when the vehicle is stationary and drive-ready state is off.

## Turning on the welcome light

You can turn on the welcome light as follows:

- ▷ Automatic activation when approaching.
- ▷ Activation when unlocking vehicle.

- ▷  With the vehicle locked, press the lock button on the vehicle key.  
Depending on the settings, the interior lighting and parts of the exterior lighting will be turned on.  
The function is not available for the first 10 seconds after locking.

## Pathway lighting

### Principle

For the pathway lighting, the exterior lighting that illuminates the vehicle's surroundings turns on for a certain period of time after leaving the vehicle.

### Switching pathway lighting on

You can turn on the pathway lighting as follows:

- ▷ After switching off the drive-ready state, briefly push the turn signal lever forward.
- ▷  On the vehicle key, press and hold the panic alarm button for approx. 1 second.

## Setting the duration

You can configure the duration of pathway lighting.

1. Go through the menu as follows: Apps menu / "Vehicle" / "Exterior lighting" / "Settings" / "Pathway lighting".
2. Select the desired setting.

## Daytime driving lights

### Principle

The daytime driving lights are used to ensure that the vehicle is more visible, e.g., in areas with sharply changing light conditions.

The daytime driving lights illuminate when drive-ready state is switched on.

### Activating/deactivating daytime driving lights

In some countries, daytime driving lights are mandatory, so it may not be possible to deactivate the daytime driving lights in front.

1. Go through the menu as follows: Apps menu / "Vehicle" / "Exterior lighting" / "Settings".
2. Depending on vehicle equipment or national-market version, select the desired setting:
  - ▷ "Daytime driving lights"
  - ▷ "Rear daytime driving lights"
  - ▷ "BMW Iconic Glow"

## Manual headlight beam throw adjustment

### Principle

Depending on vehicle equipment, the manual headlight beam throw control is used to manually adjust the range of the low-beam head-

lights to the vehicle load so that oncoming traffic is not dazzled.

## Changing settings

The headlight range control can be adjusted as follows:

1. Go through the menu as follows: Apps menu / "Vehicle" / "Exterior lighting" / "Headlight range control".
2. Select the desired setting.
  - ▷ 0 = 1 to 2 people without luggage.
  - ▷ 1 = 4 or 5 people without luggage.
  - ▷ 1 = 4 or 5 people with luggage.
  - ▷ 2 = 1 person, full cargo area.

## Adaptive headlight range control

The Adaptive Headlight Range Control compensates for vehicle acceleration, braking, and load conditions to prevent your headlights from dazzling oncoming traffic.

## Instrument lighting

### Principle

The instrument lighting illuminates switches and buttons with the individually set brightness.

The brightness of the instrument lighting can only be adjusted in darkness and when the parking lights or low-beam headlights are turned on.

### Setting the brightness

1. To adjust the brightness of the instrument lighting, go through the menu as follows: Apps menu / "Vehicle" / "Interior lighting" / "Cockpit brightness".
2. Select the desired setting.

## Interior lighting

### Principle

The interior lighting comprises all lighting elements inside the vehicle.

Depending on vehicle equipment, the following is controlled automatically:

- ▷ Interior lights.
- ▷ Footwell lights.
- ▷ Entry lights.
- ▷ Ambient light.
- ▷ Speaker lighting.

### Overview

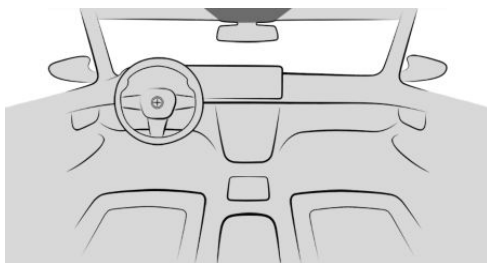

The interior lighting menu button is located in the headliner.



The buttons for reading lights are located in the headliner.



The interior light button is located in the headliner.

### Turning interior lights on/off

The interior lights can be turned on/off using the button in the headliner.



Press the interior light button in the headliner.

To turn off the interior light permanently, press and hold the button for approx. 3 seconds.

The interior lights in the rear of the vehicle can be switched on and off independently. The button is located in the rear headliner.

The interior lights can be turned on or off via iDrive.

1. Go through the menu as follows: Apps menu / "Vehicle" / "Interior lighting" / "Reading light".
2.  Select the interior lights icon.

## Turning reading lights on/off

The reading lights can be turned on/off using the button in the headliner.



In the headliner, press the desired reading light button.

Depending on the vehicle equipment, the reading lights are located next to the interior lights in the front and rear.

The reading lights can also be turned on or off via iDrive.

1. Go through the menu as follows: Apps menu / "Vehicle" / "Interior lighting" / "Reading light".
2.  Select the icon for the desired seat reading light.

The brightness of the reading lights can be adjusted when they are turned on.

## Changing settings

Depending on vehicle equipment, the brightness can be individually adjusted for specific seats.

1. Go through the menu as follows: Apps menu / "Vehicle" / "Interior lighting" / "Reading light".
2. Select the desired seat.
3. Select the desired settings.

# Ambient light

## Principle

The ambient light comprises several light elements that provide diffuse light in the vehicle interior. Depending on the vehicle equipment, you can adjust the lighting level for some lights via iDrive.

## Activating/deactivating ambient light

To activate/deactivate the ambient light, go through the menu as follows: Apps menu / "Vehicle" / "Interior lighting" / "Ambient lighting" / "Ambient lighting".

## Turning ambient light on/off

The ambient light is switched on when the vehicle is unlocked, and switched off when the vehicle is locked.

If the ambient light was deactivated via iDrive, it will not be turned on when the vehicle is unlocked.

## Selecting the color

You can choose the color of the ambient light in Personal Mode.

1. Go through the menu as follows: Apps menu / "Vehicle" / "Interior lighting" / "Ambient lighting" / "Color".
2. Select the desired setting.

## Setting the brightness

The brightness of the ambient light can be adjusted.

1. Go through the menu as follows: Apps menu / "Vehicle" / "Interior lighting" / "Ambient lighting".
2. "Background light" or "Accent lighting"
3. Select the desired setting.

## Dynamic light

With the Dynamic Light function, certain actions, e.g., incoming calls or obstacles detected when opening door, are indicated by light effects. If the ambient light is disabled, the light effects will continue to be shown, depending on vehicle equipment.

1. Go through the menu as follows: Apps menu / "Vehicle" / "Interior lighting" / "Ambient lighting" / "Lighting effects".
2. Select the desired setting.

## Reduced lighting when driving at night

Some lights of the interior lighting are reduced when the vehicle is driven in the dark.

To activate/deactivate this function, go through the menu as follows: Apps menu / "Vehicle" / "Interior lighting" / "Ambient lighting" / "Reduced for night driving".

## Speaker lighting

Some speakers in the vehicle are illuminated. The speaker lighting is switched on when the vehicle is unlocked, and switched off when the vehicle is locked.

## Window wiper system

### Principle

The wiper system makes sure that you have a clear view, e.g., in the rain. It is operated using the wiper lever on the steering wheel.

## Safety information

### WARNING

If the wipers start moving in the folded away state, body parts can be jammed or damage may occur to parts of the vehicle. There is a risk of injury and risk of property damage. Make sure that the vehicle is switched off when the wipers are in the folded-away state and the wipers are folded in when switching on.

### NOTICE

The wiper blades can become prematurely worn or damaged if used on dry window glass for long periods of time. The wiper motor can overheat. There is a risk of property damage. Do not use the wipers when the window glass is dry.

### NOTICE

If the wipers are frozen to the windshield, the wiper blades can be torn off and the wiper motor can overheat when switching on. There is a risk of property damage. Defrost the window glass before turning on the wipers.

## Turning on window wiper system

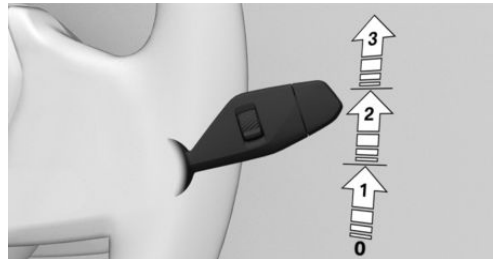

To turn on the wiper system, push the wiper lever upward to the desired position.

Position	Function
Position 0.	Rest position of wipers.
Position 1.	Rain sensor mode.
Position 2.	Normal wiper speed.
Position 3.	Fast wiper speed.

When you continue driving after stopping with the window wiper system on, the wipers will operate at the previous setting.

## Turning off the window wiper system and flick wipe

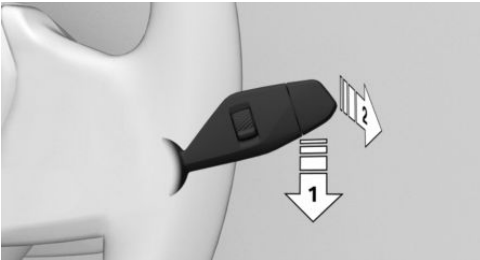

To turn off the wiper system, push the wiper lever down until it reaches position 0, arrow 1.

To flick wipe, proceed as follows:

- ▶ Push the wiper lever down from position 0, arrow 1.
- ▶ Push the wiper lever up from position 0 or position 1, arrow 2.

The wiper lever returns to its initial position when released.

## Rain sensor

### Principle

The rain sensor automatically controls the wiper operation depending on the intensity of the rainfall. The sensor is located on the windshield, directly in front of the interior mirror.

## Safety information

### NOTICE

If the rain sensor is activated, the wipers can accidentally start moving in car washes. There is a risk of property damage. Deactivate the rain sensor in car washes.

## Activating rain sensor

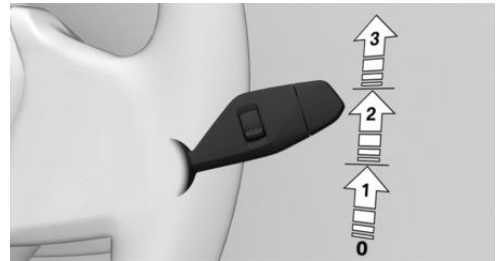

To activate the rain sensor: Push the wiper lever upward from position 0, arrow 1, once.

Wiping operation is started.

The LED in the wiper lever is illuminated.

In frosty conditions, wiping operation may not start.

## Deactivating rain sensor

To deactivate the rain sensor: Push the wiper lever back to position 0.

## Adjusting the rain sensor sensitivity

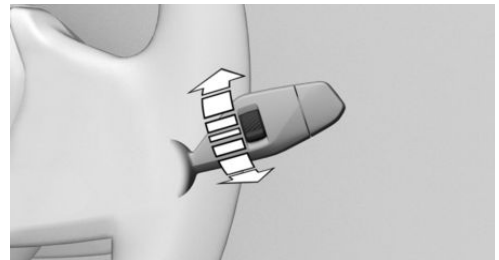

To adjust the sensitivity of the rain sensor, turn the thumbwheel on the wiper lever as follows:

- ▷ To set the rain sensor sensitivity to high, turn the thumbwheel up.
- ▷ To set the rain sensor sensitivity to low, turn the thumbwheel down.

## Window washer system

### Safety information

 **WARNING**

The washer fluid may freeze to the window glass at low temperatures and obstruct your view. There is a risk of accident, injury, and property damage. Only use the window washer system when the washer fluid will not freeze. Use antifreeze if needed.

 **NOTICE**

When the washer fluid reservoir is empty, the washer pump cannot work as intended. There is a risk of property damage. Do not use the washer system when the washer fluid reservoir is empty.

## Cleaning the windshield

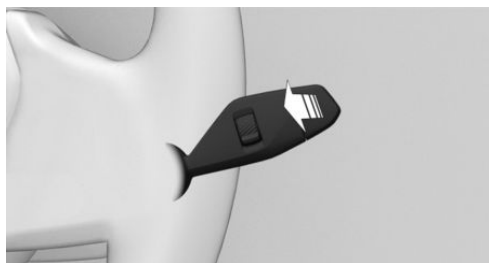

To clean the windshield, pull the wiper lever back.

The washer fluid is sprayed on the windshield, and the wipers are turned on briefly.

## Windshield washer nozzles

The windshield washer nozzles are automatically heated while standby state is switched on.

## Fold-out position of the wipers

### Principle

In the fold-out position, the wipers can be folded out from the windshield, which is important, for instance, when changing the wiper blades or for folding away under frosty conditions.

### Safety information

 **WARNING**

If the wipers start moving in the folded away state, body parts can be jammed or damage may occur to parts of the vehicle. There is a risk of injury and risk of property damage. Make sure that the vehicle is switched off when the wipers are in the folded-away state and the wipers are folded in when switching on.

 **NOTICE**

If the wipers are frozen to the windshield, the wiper blades can be torn off and the wiper motor can overheat when switching on. There is a risk of property damage. Defrost the window glass before turning on the wipers.

## Folding out the wipers

To fold the wipers away from the windshield, proceed as follows:

1. Activate standby state.
2. Push the wiper lever down or forward and hold it until the wipers stop in an approximately vertical position.

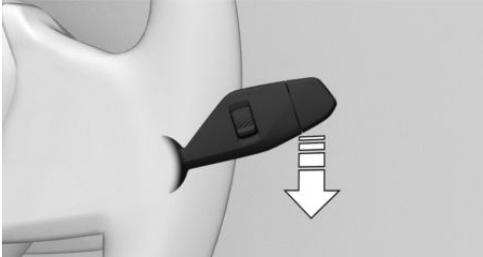

3. Fold the wipers all the way out from the windshield.



## Folding in the wipers

To fold in the wipers, proceed as follows:

1. Fold the wipers back in toward the windshield.
2. Turn on standby state, then press the wiper lever down or forward again and hold it.

The wipers return to their rest position and are ready for operation.

# Safety

## Vehicle features and options

This chapter describes model-specific equipment, systems, and functions that are currently available, or may become available in the future, even if they are not present in the vehicle.

Additional information:

Vehicle equipment, refer to page 8.

## Overview

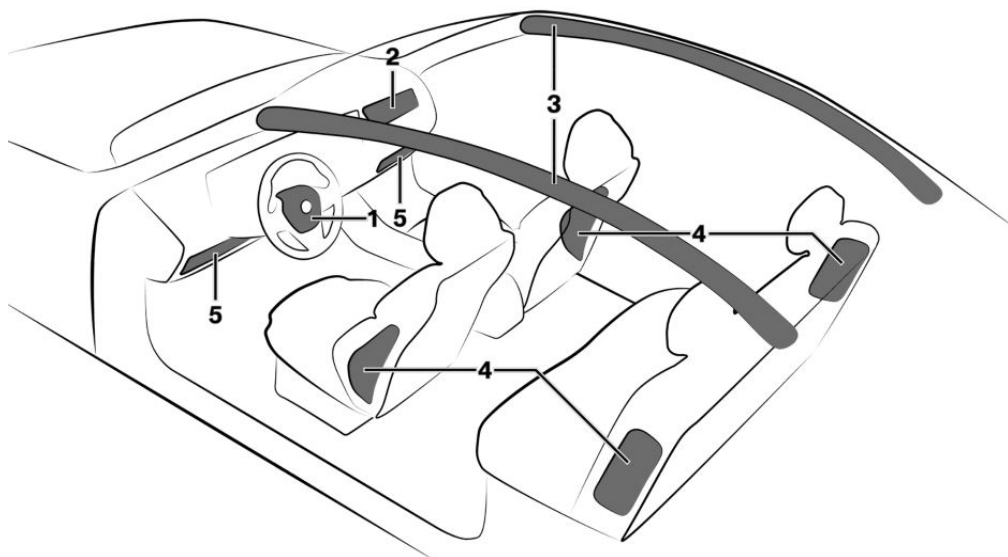

- |  |                      |
|--|----------------------|
| <b>1</b> Front airbag, driver          | <b>4</b> Side airbag |
| <b>2</b> Front airbag, front passenger | <b>5</b> Knee airbag |
| <b>3</b> Head airbag                   |                      |

## Front airbag

The front airbag helps protect the driver and front passenger in the event of a frontal impact in which the seat belts alone would not provide adequate protection.

## Airbags

### Principle

The airbag system provides additional protection in the event of an accident, especially if the seat belt is worn correctly.

## Side airbag

In the event of a side collision, the side airbag protects the side of the body in the chest and pelvic regions.

## Head airbag

In the event of a side collision, the head airbag protects the head.

## Ejection Mitigation

The head airbag system is designed as an ejection mitigation countermeasure to reduce the likelihood of ejections of vehicle occupants through side windows during rollovers or side collision events.

## Knee airbag

The availability of the knee airbag depends on the national-market version.

The knee airbag protects the legs in the event of a frontal impact.

## Protective effect

### General information

Airbags are not deployed in every impact situation, e.g., not in less severe accidents.

### Information on optimum protective effect of the airbags

#### **WARNING**

If the seat position is incorrect, the seat belts are fastened incorrectly or the deployment area of the airbags is impaired, the airbag system cannot provide protection as intended and may cause additional injuries due to deployment. There is a risk of injury and danger to life. Follow the information on achieving the optimum protective effect of the airbag system.

To ensure that the airbag system has the optimum protective effect, note the following:

- ▷ Always grasp the steering wheel on the steering wheel rim. Hold hands at the 3 o'clock and 9 o'clock positions to keep the risk of injuring hands or arms as low as possible when the airbag deploys.
  - ▷ Adjust the seat and steering wheel so that hands can reach over the steering wheel diagonally. Select the settings so that when reaching over the steering wheel the shoulders rest against the backrest and the upper body is as far away as possible from the steering wheel.
  - ▷ Make sure that the front passenger is sitting correctly, i.e., with their feet and legs in the footwell, not resting on the dashboard.
  - ▷ Make sure that occupants keep their heads away from the side airbag.
  - ▷ There should be no additional persons, animals or objects between an airbag and a person.
  - ▷ Keep the dashboard and windshield on the front passenger side clear, i.e., do not cover with adhesive film or other coating, and do not attach mounts for, e.g., navigation devices or mobile phones.
  - ▷ Do not bond the airbag cover panels with adhesive, do not cover them, and do not modify them in any way.
  - ▷ Do not use the airbag cover on the front passenger side for storage.
  - ▷ Keep storage compartments near the airbags closed, e.g., glove compartment or center armrest.
  - ▷ Do not place slip covers, seat cushions, or other objects on the front seats unless they are specifically designed for seats with integrated airbags.
  - ▷ Do not hang pieces of clothing such as jackets over the backrests.
  - ▷ Do not modify individual components or wiring. This also applies to the dashboard, steering wheel covers, and seats.
- ▷ Keep a distance from the airbags.
  - ▷ Fasten seat belts correctly.

- ▷ Do not attach any objects to the steering wheel, e.g., mobile phone holders or trim elements.
- ▷ Do not disassemble the airbag system.

Even when all instructions are followed closely, the airbags may still cause injury upon contact in certain situations.

The ignition and inflation noise may lead to short-term and, in most cases, temporary hearing impairment in sensitive occupants.

Vehicle modifications for a person with disabilities may affect the airbag system; contact BMW Customer Relations for further information.

Additional warnings and information on the airbags are also found on the sun visors.

## Operational readiness of the airbag system

### Safety information

#### WARNING

Individual components can be hot after deployment of the airbag system. There is a risk of injury. Do not touch individual components.

#### WARNING

Improperly executed work can lead to failure, malfunction or unintentional deployment of the airbag system. In the case of a malfunction, the airbag system might not deploy as intended despite the accident severity. There is a risk of injury and danger to life. Have the airbag system checked, repaired, disassembled, and scrapped by an authorized service center or another qualified service center or repair shop.

## Display in the instrument cluster



The airbag system warning light on the instrument cluster illuminates briefly when drive-ready state is turned on, thus indicating the operational readiness of the entire airbag system and seat belt tensioners.

## Malfunction



▷ The airbag system warning light on the instrument cluster does not illuminate when drive-ready state is on.

▷ The airbag system warning light on the instrument cluster illuminates continuously.

The airbag system or the seat belt tensioners may not be operational. Have the vehicle checked immediately by an authorized service center or another qualified service center or repair shop.

## Setting the front seat positions

The power that deploys the driver's/front passenger airbags depends on the position of the driver's/front passenger seat.

To maintain the accuracy of this function, calibrate the electrical front seats as soon as a respective message appears on the control display.

Additional information:

Seats, refer to page 96.

## Deactivating the front passenger airbag automatically

### Principle

The automatic front passenger airbag deactivation system can detect if the front passenger seat is occupied.

The front passenger airbag is activated or deactivated accordingly.

## Safety information

### WARNING

To ensure the front passenger airbag function, the system must be able to detect whether a person is sitting in the front passenger seat. The entire seat surface must be used for this purpose. There is a risk of injury and danger to life. Make sure that the front passenger keeps his or her feet in the footwell.

## Functional requirements

To ensure that occupants in the front passenger seat are detected properly, the following functional requirements must be met:

- ▶ Do not attach covers, cushions, ball mats or other items to the front passenger seat unless they are specifically determined to be safe for use on the front passenger seat.
- ▶ Do not place objects under the seat that can press against the seat from below.
- ▶ Sit upright in the seat with the back against the backrest.
- ▶ Sit down with your feet touching the floor.

## Installing child restraint systems

To ensure that occupants on the front passenger seat are detected properly, note the following:

- ▶ When using child restraint systems, pay close attention to the operating and safety instructions provided by the child restraint system manufacturer.
- ▶ Make sure that the seat surface of the child restraint system rests as flat as possible on the seat surface.
- ▶ Move the head restraint up or remove it to ensure that the child restraint system rests

as flat as possible against the rear seat backrest.

- ▶ Observe the maximum size of the child restraint system, for example to avoid possible touching the roof.

Before transporting a child on the front passenger seat, refer to the safety information and instructions in the section "Children on the front passenger seat".

Additional information:

Install child restraint systems, refer to page 111.

## Indicator light, front passenger airbag

The front passenger airbag indicator light in the headliner shows the operating state of the front passenger airbag.

The indicator light shows whether the airbag is activated or deactivated.

After drive-ready state is turned on, the indicator light illuminates briefly and then shows whether the airbag is activated or deactivated.

### Display

### Function

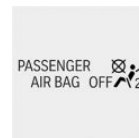

The indicator light is continuously illuminated when the seat is not occupied or when a child is detected on the seat in a provided child restraint system as intended. The airbag on the front passenger's side is not activated.

The indicator light does not illuminate when, for instance, a correctly seated person of sufficient size is detected on the seat. The airbag on the front passenger's side is activated.

When the front passenger seat is occupied, check the indicator light in the headliner before and while driving.

## Fault of the automatic deactivation system

For adolescents and adults, the front passenger airbag may deactivate in certain seat positions. In this case, the indicator light for the front passenger airbag illuminates in the headliner.

In this case, change the seat position so that the front passenger airbag activates and the indicator light goes out.

If it is not possible to establish the desired condition, have the person sit in the rear seat.

## Occupancy detection

The occupant detection system satisfies the legal requirements of Federal Motor Vehicle Safety Standard FMVSS 208 and deactivates the front passenger airbag under certain conditions.

## Collision warning systems

### Principle

The Intelligent Safety systems can help prevent an impending collision. To do so, the area around the vehicle is monitored by various sensors.

Depending on vehicle equipment, various safety and warning systems are available:

- ▶ Forward Collision Mitigation with brake intervention, refer to page 169.
- ▶ The Exit Warning, refer to page 181.
- ▶ The Lane Departure Warning, refer to page 183.
- ▶ The Active Blind Spot Detection, refer to page 186.
- ▶ The Side Collision Protection, refer to page 189.
- ▶ The Rear-End Collision Preparation, refer to page 191.

- ▶ The Traffic Light and Sign Warning, refer to page 192.
- ▶ The Wrong Way Warning, refer to page 195.
- ▶ No Turn on Red Information, refer to page 196.
- ▶ The Emergency Stop Assistant, refer to page 197.

The Intelligent Safety Systems can be activated or deactivated on the control display. Some functions, e.g., warning times, can be configured.

## Safety information

### WARNING

The system cannot serve as a substitute for the driver's personal judgment in assessing the traffic situation. Based on the limits of the system, it cannot independently react to all traffic situations. There is a risk of accident, injury, and property damage. Adjust driving style to traffic conditions. Watch the surrounding traffic situation closely, be ready to take over steering and braking at any time, and actively intervene where appropriate.

### WARNING

Indicators and warnings cannot serve as a substitute for the driver's personal judgment. Due to its limits, the system may not issue warnings or responses, or these may be issued late or in a manner that is not consistent with their normal use. There is a risk of accident, injury, and property damage. Adjust driving style to traffic conditions. Watch surrounding traffic closely and actively intervene where appropriate.

## Sensors

Depending on vehicle equipment, the Intelligent Safety systems are controlled by the following sensors:

- ▶ Camera behind the windshield.
- ▶ Front radar sensor.
- ▶ Side radar sensors, front.
- ▶ Side radar sensors, rear.

Additional information:

Sensors of the vehicle, refer to page [34](#).

## Activating/deactivating/adjusting Intelligent Safety systems

1. To activate/deactivate Intelligent Safety systems or configure settings, go through the menu as follows: Apps menu / "Vehicle" / "Driving settings" / "Driver Assistance" / "Safety and warnings".
2. Select the desired settings.

Depending on national-market version, some Intelligent Safety Systems are automatically activated whenever you start driving.

## Resetting the settings

The settings of the collision warning systems can be reset to the default settings at vehicle outbound delivery.

Go through the menu as follows: Apps menu / "Vehicle" / "Driving settings" / "Driver Assistance" / "Safety and warnings" / "Reset to recommended settings".

## System limits

### Safety information

#### **WARNING**

Because of system limitations, this system may either not respond, or respond too late, incorrectly, or without cause. There is a risk of accident, injury, and property damage. Ac-

tively intervene as warranted. Refer to the information in this Owner's Manual regarding the scope of the system's operation and limitations.

## Detection capability

The detection capability of the collision warning systems is limited.

The system only takes into account objects that are located in the detection range of the installed sensors and are detected by the system.

Depending on the vehicle equipment, the area is monitored by cameras or radar sensors.

Thus, a system response might not come or might come late.

## System limits of the sensors

The Intelligent Safety systems may be restricted by the system limits of the sensors.

Additional information:

Sensors of the vehicle, refer to page [34](#).

## Forward Collision Mitigation with brake intervention

### Principle

Forward Collision Mitigation with brake intervention can help to prevent accidents within a certain speed range. To do so, the area around the vehicle is monitored by various sensors.

If an accident cannot be avoided, the system can help reduce the severity of the accident. The system can issue a warning of a possible risk of collision and activate the brakes independently, if needed. You can cancel automatic brake intervention manually, e.g., by actively moving the steering wheel.

Depending on vehicle equipment, the Forward Collision Mitigation system includes the following functions:

- ▷ The Rear-end collision warning function, refer to page 172.
- ▷ The oncoming traffic warning function, refer to page 174.
- ▷ The oncoming traffic warning function when turning, refer to page 175.
- ▷ The pedestrian warning function, refer to page 176.
- ▷ The intersection warning function, refer to page 178.
- ▷ The Evasion Assistant, refer to page 179.

Forward Collision Mitigation can be activated or deactivated on the control display. You can also configure the warning time. Depending on the detected risk of collision, various indicator lights and warning lights are displayed on the instrument cluster.

## Safety information

### WARNING

The system cannot serve as a substitute for the driver's personal judgment in assessing the traffic situation. Based on the limits of the system, it cannot independently react to all traffic situations. There is a risk of accident, injury, and property damage. Adjust driving style to traffic conditions. Watch the surrounding traffic situation closely, be ready to take over steering and braking at any time, and actively intervene where appropriate.

### WARNING

Indicators and warnings cannot serve as a substitute for the driver's personal judgment. Due to its limits, the system may not issue warnings or responses, or these may be issued late or in a manner that is not consistent with their normal use. There is a risk of accident, injury, and property damage. Adjust driving style to traffic conditions. Watch sur-

rounding traffic closely and actively intervene where appropriate.

## Sensors

Depending on vehicle equipment, the Forward Collision Mitigation system is controlled by the following sensors:

- ▷ Camera behind the windshield.
- ▷ Front radar sensor.
- ▷ Side radar sensors, front.

Additional information:

Sensors of the vehicle, refer to page 34.

## Speed range

The Forward Collision Mitigation system issues a warning for a possible risk of collision at speeds above approx. 3 mph/5 km/h.

If the vehicle speed exceeds approx.

155 mph/250 km/h, the system is deactivated temporarily.

Some functions are deactivated earlier.

The system is enabled as soon as the speed drops below this value again.

## Activating/deactivating the Forward Collision Mitigation

### Automatic activation of system

Depending on national-market version, the Forward Collision Mitigation is automatically activated whenever you start driving.

### Activating the system manually

The Forward Collision Mitigation is activated by setting the warning time.

Additional information:

Set the warning time for Forward Collision Mitigation, refer to page 171.

## Deactivating the system manually

Depending on national-market version, you must significantly reduce your vehicle's speed or stop your vehicle in order to deactivate the Forward Collision Mitigation manually. Forward Collision Mitigation is deactivated via iDrive.

You may need to successively confirm deactivation on the control display.

Go through the menu as follows: Apps menu / "Vehicle" / "Driving settings" / "Driver Assistance" / "Safety and warnings" / "Forward Collision Mitigation" / "Off".

## Setting the warning time for Forward Collision Mitigation

You can configure the warning time at which Forward Collision Mitigation should issue a warning.





1. Go through the menu as follows: Apps menu / "Vehicle" / "Driving settings" / "Driver Assistance" / "Safety and warnings" / "Forward Collision Mitigation".
2. Select the desired setting.

The more sensitive the warning time is set to be, the more warnings will be displayed. The system can therefore also issue more early or unfounded warnings and reactions.

The system checks for visual impairments. Depending on the vehicle equipment, the Driver Attention Camera in the instrument cluster captures the driver's field of vision. Visibility and gaze behavior also affect the timing of warnings.

## Display in the instrument cluster

Forward Collision Mitigation is shown on the instrument cluster and, depending on vehicle equipment, Head-up display by various indicator lights and warning lights:

Icon	Meaning
	Risk of collision with a person, e.g., a pedestrian.
	Risk of collision, for instance with an oncoming or a vehicle driving ahead.
	Risk of collision, e.g., with a vehicle crossing from the right.
	Risk of collision, e.g., with a vehicle crossing from the left.
	General risk of collision.

Indicator lights and warning lights may be displayed differently since the system has detected multiple objects.

## Warning function

The Forward Collision Mitigation warns on different warning levels, depending on the respective hazardous situation.

In the event of a prewarning, a warning light illuminates red. In the event of an acute warning, a warning light flashes red and a warning tone sounds.

In the event of a system warning, the driver must intervene immediately and in accordance with the situation.

- ▷ Red warning light illuminates:
  - A hazardous situation has been detected. Increased awareness is required.
- ▷ Red warning light flashes:
  - There is a risk of collision. Intervene immediately.
- ▷ A warning signal sounds:
  - There is a risk of collision. Intervene immediately.
- ▷ Automatic brake intervention:

Depending on the equipment and situation in case of risk of imminent collision, the system can also intervene with an automatic brake intervention and automatically decelerate the vehicle, if necessary, to a complete stop.

When the brake pedal is depressed quickly and hard, the maximum brake power of the vehicle is used.

## Automatic brake intervention

If there is a risk of collision, the Forward Collision Mitigation system can assist with an automatic brake intervention, if necessary.

When the vehicle is traveling at a low speed, the vehicle may come to a complete stop.

A brake intervention can be canceled by depressing the accelerator pedal with sufficient force, releasing the brake pedal, or by actively steering.

Depending on the equipment and situation, the brake intervention can occur up to approx. 155 mph/250 km/h.

At speeds above approx. 130 mph/210 km/h, only a brief brake intervention will occur.

## System limits

### Safety information

#### WARNING

Because of system limitations, this system may either not respond, or respond too late, incorrectly, or without cause. There is a risk of accident, injury, and property damage. Actively intervene as warranted. Refer to the information in this Owner's Manual regarding the scope of the system's operation and limitations.

## Detection capability

The detection capability of the Forward Collision Mitigation is restricted.

The system only takes into account objects that are located in the detection range of the installed sensors and are detected by the system.

Depending on the vehicle equipment, the area is monitored by cameras or radar sensors.

Thus, a system response might not come or might come late.

## System limits of the sensors

Forward Collision Mitigation may be restricted by the system limits of the sensors.

Additional information:

Sensors of the vehicle, refer to page 34.

## Functional limitations

The Forward Collision Mitigation system may be limited in the following situations:

- ▶ In tight curves.
- ▶ With limitation of the driving stability control systems.
- ▶ Up to 10 seconds after turning on drive-ready state using the Start/Stop button.

Also, do not use Forward Collision Mitigation when towing.

## Warning function in rear-end collision situations

### Principle

The rear-end collision function warns you of a possible collision risk by displaying a warning light on the instrument cluster. This system also brakes automatically when necessary. You can cancel automatic brake intervention manually, e.g., by actively moving the steering wheel.

In the event of an accident, the system helps by reducing impact speed.

The time of warnings may vary depending on the current driving situation.

The system considers the driver's vehicle handling when responding. If an active driving style is detected, warnings and brake interventions occur less frequently.

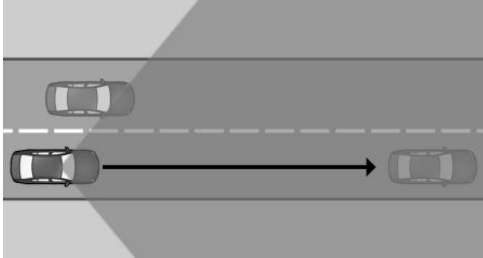

The sensors detect the traffic situation in their detection range.

## Safety information

### **WARNING**

The system cannot serve as a substitute for the driver's personal judgment in assessing the traffic situation. Based on the limits of the system, it cannot independently react to all traffic situations. There is a risk of accident, injury, and property damage. Adjust driving style to traffic conditions. Watch the surrounding traffic situation closely, be ready to take over steering and braking at any time, and actively intervene where appropriate.

### **WARNING**

Indicators and warnings cannot serve as a substitute for the driver's personal judgment. Due to its limits, the system may not issue warnings or responses, or these may be issued late or in a manner that is not consistent with their normal use. There is a risk of accident, injury, and property damage. Adjust

driving style to traffic conditions. Watch surrounding traffic closely and actively intervene where appropriate.

## Speed range

The rear-end collision warning function is activated when your vehicle speed is greater than approx. 3 mph/5 km/h.

## Display in the instrument cluster

If there is a risk of collision with a detected vehicle, a warning light is shown on the instrument cluster and Head-up display, depending on vehicle equipment.

Icon	Meaning
	Forward Collision Warning with a detected vehicle.
	General risk of collision.



Forward Collision Warning with a detected vehicle.



General risk of collision.

## Warning function

The rear-end collision warning function issues warnings on different levels, depending on the respective hazard situation. This system prompts the driver to intervene manually.

Additional information:

Forward Collision Mitigation, refer to page 169.

## System limits

### General information

Observe the system limits in Chapter "Forward Collision Mitigation with Brake Intervention".

### Detection range

With the rear-end collision warning function, the following may not be detected or may be detected only with a delay in the detection range of the sensors, e.g.:

- ▶ Preceding vehicle driving slowly and being approached at high speed.
- ▶ Vehicles that suddenly swerve in front of you, or strongly decelerating vehicles.
- ▶ Vehicles with unusual rear designs.

## Warning function for oncoming traffic

### Principle

The oncoming traffic warning function warns you of a possible risk of collision with oncoming traffic by displaying a warning light on the instrument cluster. This system also brakes automatically when necessary. You can cancel automatic brake intervention manually, e.g., by actively moving the steering wheel.

In the event of an accident, the system helps by reducing impact speed.

The time of warnings may vary depending on the current driving situation.

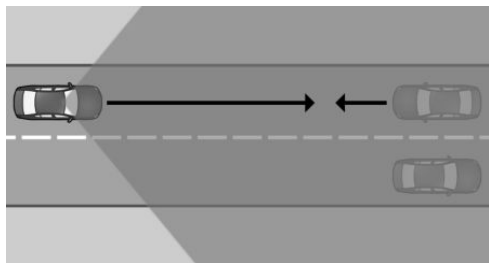

The sensors detect the traffic situation in their detection range.

### Safety information

#### WARNING

The system cannot serve as a substitute for the driver's personal judgment in assessing the traffic situation. Based on the limits of the system, it cannot independently react to all traffic situations. There is a risk of acci-

dent, injury, and property damage. Adjust driving style to traffic conditions. Watch the surrounding traffic situation closely, be ready to take over steering and braking at any time, and actively intervene where appropriate.

#### WARNING

Indicators and warnings cannot serve as a substitute for the driver's personal judgment. Due to its limits, the system may not issue warnings or responses, or these may be issued late or in a manner that is not consistent with their normal use. There is a risk of accident, injury, and property damage. Adjust driving style to traffic conditions. Watch surrounding traffic closely and actively intervene where appropriate.

### Speed range

The oncoming traffic warning is activated when your vehicle speed is greater than approx. 3 mph/5 km/h.

### Display in the instrument cluster

If there is a risk of collision with a detected vehicle, a warning light is shown on the instrument cluster and Head-up display, depending on vehicle equipment.

Icon	Meaning
	Oncoming traffic warning when a vehicle is detected.
	General risk of collision.



Oncoming traffic warning when a vehicle is detected.



General risk of collision.

### Warning function

The oncoming traffic warning function issues warnings on different levels, depending on the respective hazard situation. This system prompts the driver to intervene manually.

In case of a possible risk of collision, a brake intervention is triggered.

Additional information:

Forward Collision Mitigation, refer to page 169.

## System limits

### General information

Observe the system limits in Chapter "Forward Collision Mitigation with Brake Intervention".

### Detection range

With the oncoming traffic warning function, the following may not be detected or may be detected only with a delay in the detection range of the sensors, e.g.:

- ▷ Oncoming vehicles at a very high speed.
- ▷ Vehicles with an unusual front view.

## Warning function for turning with oncoming traffic

### Principle

The warning function for turning with oncoming traffic warns you of a possible risk of collision with oncoming traffic by displaying a warning light on the instrument cluster. This system also brakes automatically when necessary. You can cancel automatic brake intervention manually, e.g., by actively moving the steering wheel.

In the event of an accident, the system helps by reducing impact speed.

The time of warnings may vary depending on the current driving situation.

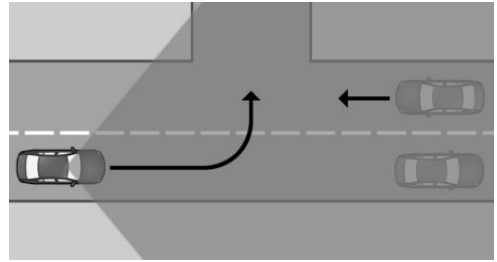

The sensors detect the traffic situation in their detection range.

## Safety information

### WARNING

The system cannot serve as a substitute for the driver's personal judgment in assessing the traffic situation. Based on the limits of the system, it cannot independently react to all traffic situations. There is a risk of accident, injury, and property damage. Adjust driving style to traffic conditions. Watch the surrounding traffic situation closely, be ready to take over steering and braking at any time, and actively intervene where appropriate.

### WARNING

Indicators and warnings cannot serve as a substitute for the driver's personal judgment. Due to its limits, the system may not issue warnings or responses, or these may be issued late or in a manner that is not consistent with their normal use. There is a risk of accident, injury, and property damage. Adjust driving style to traffic conditions. Watch surrounding traffic closely and actively intervene where appropriate.



## Speed range

The warning function for turning is activated when your vehicle speed is greater than approx. 3 mph/5 km/h.

This system reacts when your vehicle speed is less than approx. 15 mph/25 km/h.

### Display in the instrument cluster

If there is a risk of collision with a detected vehicle, a warning light is shown on the instrument cluster and Head-up display, depending on vehicle equipment.

Icon	Meaning
	Oncoming traffic warning when a vehicle is detected.
	General risk of collision.

### Warning function

The warning function for turning with oncoming traffic issues warnings on different levels, depending on the respective hazard. This system prompts the driver to intervene manually.

Additional information:

Forward Collision Mitigation, refer to page 169.

### System limits

#### General information

Observe the system limits in Chapter "Forward Collision Mitigation with Brake Intervention".

#### Detection range

With the warning function for turning with oncoming traffic, the following may not be detected or may be detected only with a delay in the detection range of the sensors, e.g.:

- ▶ Oncoming vehicles at a very high speed.
- ▶ Vehicles that are hidden by other vehicles.
- ▶ Vehicles with an unusual front view.

## Warning function for pedestrians

### Principle

The Pedestrian Warning system warns you of a possible risk of collision with pedestrians and cyclists by displaying a warning light on the instrument cluster. This system also brakes automatically when necessary. You can cancel automatic brake intervention manually, e.g., by actively moving the steering wheel.

The system issues warnings for speeds that are common in towns and cities.

In the event of an accident, the system helps by reducing impact speed.

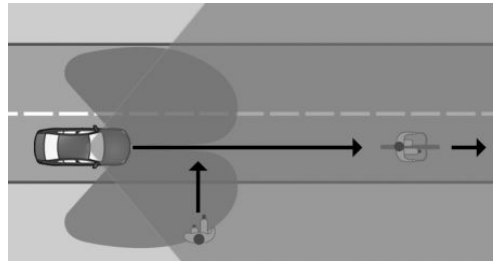

The sensors detect the traffic situation in their detection range on a straight road.

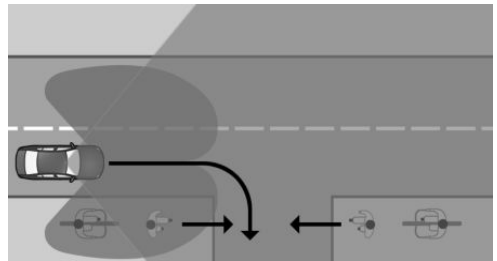

In addition, the sensors detect the traffic situation in their detection range when turning.

## Safety information

### WARNING

The system cannot serve as a substitute for the driver's personal judgment in assessing the traffic situation. Based on the limits of the system, it cannot independently react to all traffic situations. There is a risk of accident, injury, and property damage. Adjust driving style to traffic conditions. Watch the surrounding traffic situation closely, be ready to take over steering and braking at any time, and actively intervene where appropriate.

### WARNING

Indicators and warnings cannot serve as a substitute for the driver's personal judgment. Due to its limits, the system may not issue warnings or responses, or these may be issued late or in a manner that is not consistent with their normal use. There is a risk of accident, injury, and property damage. Adjust driving style to traffic conditions. Watch surrounding traffic closely and actively intervene where appropriate.

## Speed range

The Pedestrian Warning function is activated when your vehicle speed is greater than approx. 3 mph/5 km/h.

Depending on vehicle equipment, this system reacts when your vehicle speed is less than approx. 50 mph/80 km/h.

## Display in the instrument cluster

If there is a risk of collision with a detected pedestrian or cyclist, a warning light is shown on the instrument cluster and Head-up display, depending on vehicle equipment.

### Icon Meaning



Risk of collision with a person, e.g., a pedestrian.



General risk of collision.

## Warning function

The Pedestrian Warning system issues warnings on different levels, depending on the respective hazard situation. This system prompts the driver to intervene manually.

Additional information:

Forward Collision Mitigation, refer to page 169.

## System limits

### General information

Observe the system limits in Chapter "Forward Collision Mitigation with Brake Intervention".

### Detection range

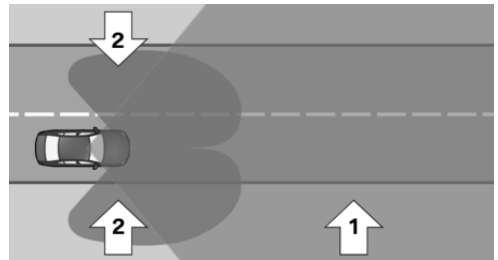

With the Pedestrian Warning, the sensor detection range consists of the following:

- ▶ From area in front of vehicle, arrow 1.
- ▶ If vehicle is equipped with front side radar sensors, side areas, arrows 2.

The following situations may not be detected, for instance:

- ▷ Partially covered pedestrians or bikes.
- ▷ Pedestrians that are not detected as such because of their contour or posture.
- ▷ Pedestrians who are too small for the sensors to detect.

## Warning function at intersections

### Principle

The Intersection Warning function warns you of a possible risk of collision with crossing traffic by displaying a warning light on the instrument cluster. This system also brakes automatically when necessary. You can cancel automatic brake intervention manually, e.g., by actively moving the steering wheel.

At intersections and junctions, this system issues warnings for speeds that are common in towns and cities.

In the event of an accident, the system helps by reducing impact speed.

The time of warnings may vary depending on the current driving situation.

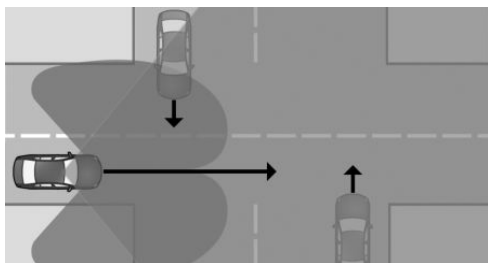

The sensors detect the traffic situation in their detection range.

Vehicles crossing your driving direction can be detected by the system as soon as these vehicles enter into detection range of the sensors.

## Safety information

### **⚠ WARNING**

The system cannot serve as a substitute for the driver's personal judgment in assessing the traffic situation. Based on the limits of the system, it cannot independently react to all traffic situations. There is a risk of accident, injury, and property damage. Adjust driving style to traffic conditions. Watch the surrounding traffic situation closely, be ready to take over steering and braking at any time, and actively intervene where appropriate.

### **⚠ WARNING**

Indicators and warnings cannot serve as a substitute for the driver's personal judgment. Due to its limits, the system may not issue warnings or responses, or these may be issued late or in a manner that is not consistent with their normal use. There is a risk of accident, injury, and property damage. Adjust driving style to traffic conditions. Watch surrounding traffic closely and actively intervene where appropriate.

### **⚠ Warning**

When towing while safety systems or driver assistance systems are activated, the behavior of the individual systems may lead to an accident, e.g., due to automatic braking or acceleration. There is a risk of accident, injury, and property damage. Do not use the corresponding safety systems or driver assistance systems when towing.



## Speed range

The Intersection Warning is activated when your vehicle speed is greater than approx. 3 mph/5 km/h.

The system responds to crossing vehicles when the vehicle speed is below approx. 50 mph/80 km/h.

## Display in the instrument cluster

If there is a risk of collision with a detected vehicle, a warning light is shown on the instrument cluster and Head-up display, depending on vehicle equipment.

Icon	Meaning
	Risk of collision with vehicle crossing from the right.
	Risk of collision with vehicle crossing from the left.
	General risk of collision.

## Warning function

The Intersection Warning system issues warnings on different levels, depending on the respective hazard. This system prompts the driver to intervene manually.

Additional information:

Forward Collision Mitigation, refer to page 169.

## System limits

### General information

Observe the system limits in Chapter "Forward Collision Mitigation with Brake Intervention".

### Detection range

With the Intersection Warning function, the following may not be detected or may be detected only with a delay in the detection range of the sensors, e.g.:

- ▷ Crossing vehicles when they are hidden, e.g. by buildings.
- ▷ Vehicles with an unusual side view.
- ▷ Vehicles in highly dynamic driving situations.

## Evasion Assistant

### Principle

The Evasion Assistant can help the driver perform evasive maneuvers in certain situations, e.g., when obstacles or pedestrians appear suddenly. This system intervenes actively to assist the driver if it is possible to make an evasive maneuver to the side.

If the system detects sufficient free space alongside the vehicle, it helps the driver perform an evasive maneuver safely.

The system warns the driver of a possible risk of collision by displaying various warning lights on the instrument cluster.

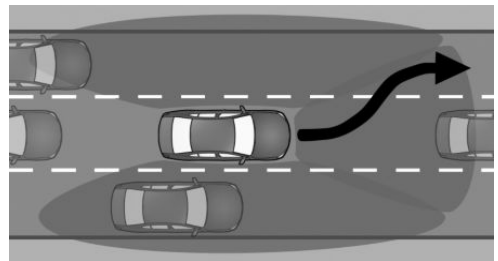

The sensors monitor and detect the clearance in front of the vehicle. Depending on the vehicle equipment, the areas next to the vehicle are also monitored.

## Safety information

### WARNING

The system cannot serve as a substitute for the driver's personal judgment in assessing the traffic situation. Based on the limits of the system, it cannot independently react to all traffic situations. There is a risk of accident, injury, and property damage. Adjust driving style to traffic conditions. Watch the surrounding traffic situation closely, be ready to take over steering and braking at any time, and actively intervene where appropriate.

### WARNING

Indicators and warnings cannot serve as a substitute for the driver's personal judgment. Due to its limits, the system may not issue warnings or responses, or these may be issued late or in a manner that is not consistent with their normal use. There is a risk of accident, injury, and property damage. Adjust driving style to traffic conditions. Watch surrounding traffic closely and actively intervene where appropriate.

## Functional requirements

To use the Evasion Assistant, the following functional requirements must be met:

- ▶ Forward Collision Mitigation is active.
- ▶ Sensors have detected sufficient clearance around the vehicle.

## Speed range

The Evasion Assistant helps the driver when the vehicle speed is between approx. 19 mph/30 km/h to 100 mph/160 km/h.

## Display in the instrument cluster

If there is a risk of collision with a detected vehicle or person, e.g., a pedestrian, a warning

light appears on the instrument cluster and, depending on vehicle equipment, on the Head-up display.

Icon	Meaning
	Warning when a vehicle is detected.
	Risk of collision with a pedestrian.
	Risk of collision with unknown obstacle.



Warning when a vehicle is detected.



Risk of collision with a pedestrian.



Risk of collision with unknown obstacle.

## Warning function with evasion support

If the vehicle approaches another object at a high differential speed, a warning is displayed if there is an immediate risk of collision.

Intervene in case of a warning.

The system is designed to provide assistance during evasive maneuvers when there is a risk of collision.

A message in the instrument cluster and, depending on the equipment, in the Head-up display signals the evasion support.

## System limits

### General information

Observe the system limits in Chapter "Forward Collision Mitigation with Brake Intervention".

### Detection range

With the Evasion Assistant, the following may not be detected in the sensor detection range, e.g.:

- ▶ Preceding vehicle driving slowly and being approached at high speed.
- ▶ Vehicles that suddenly swerve in front of you, or strongly decelerating vehicles.
- ▶ Vehicles with unusual rear designs.

- ▷ Two-wheeled vehicles ahead of you.
- ▷ Partially covered pedestrians or bikes.
- ▷ Pedestrians that are not detected as such because of their contour or posture.
- ▷ Pedestrians who are too small for the sensors to detect.

## Exit Warning

### Principle

The Exit Warning helps to avoid accidents.

The system monitors the vehicle's surroundings for a limited time after you get in or park. When opening doors, vehicle occupants are then warned if a risk of collision with an approaching object is detected.

A possible risk of collision is indicated by various warnings, e.g., warning light on the exterior mirror and a warning tone.

The warning light in the exterior mirror gives warnings at different levels.

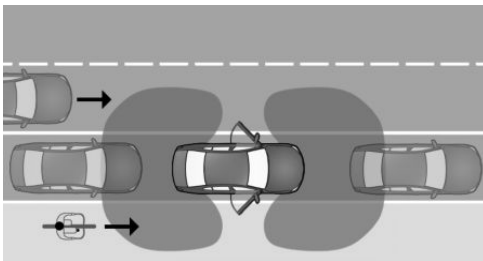

The sensors monitor the area behind the vehicle.

Depending on the vehicle equipment, the area around the vehicle in front of the vehicle is monitored as well.

The Exit Warning can be activated or deactivated on the control display.

The warning function can also be configured depending on national-market version.

## Safety information

### WARNING

The system cannot serve as a substitute for the driver's personal judgment in assessing the traffic situation. Based on the limits of the system, it cannot independently react to all traffic situations. There is a risk of accident, injury, and property damage. Pay attention to surrounding traffic and react accordingly as necessary.

### WARNING

Indicators and warnings cannot serve as a substitute for the driver's personal judgment. Due to its limits, the system may not issue warnings or responses, or these may be issued late or in a manner that is not consistent with their normal use. There is a risk of accident, injury, and property damage. Adjust driving style to traffic conditions. Watch surrounding traffic closely and actively intervene where appropriate.

## Sensors

The Exit Warning is controlled by the following sensors:

- ▷ Side radar sensors, rear.
- ▷ Depending on whether vehicle is equipped with side front radar sensors.

## Activating/deactivating the Exit Warning

### Automatic activation of system

The Exit Warning activates automatically whenever you start driving if this function was switched on when you completed your last trip.

## Deactivating the system manually

1. To deactivate the Exit Warning, go through the menu as follows: Apps menu / "Vehicle" / "Driving settings" / "Driver Assistance" / "Safety and warnings" / "Exit Warning".
2. Select the desired setting.

Depending on national-market version, this system activates automatically at the start of every drive.

## Configuring the Exit Warning

1. To configure the Exit Warning, go through the menu as follows: Apps menu / "Vehicle" / "Driving settings" / "Driver Assistance" / "Safety and warnings" / "Exit Warning".
2. Select the desired setting.

Depending on national-market version, it may not be possible to configure the warning function.

## Turning the warning signal on/off

To turn the Exit Warning tone on/off, go through the menu as follows: Apps menu / "Vehicle" / "Driving settings" / "Driver Assistance" / "Safety and warnings" / "Exit Warning" / "Warning tone".

Depending on national-market version, the warning tone cannot be turned off.

## Displays

### Warning light in exterior mirror



The warning light in the exterior mirror warns of a possible collision with a detected vehicle.

### Ambient light

Depending on the equipment, warnings are also indicated by the ambient light in the interior.

### Warning function

#### Prewarning

In the event of a prewarning for the Exit Warning, the warning light on the exterior mirror illuminates. Depending on the equipment, the ambient light also flashes.

An object was detected in the opening area of the doors. Increased awareness is required.

#### Acute warning

In the event of an acute Exit Warning, the warning light on the exterior mirror flashes, as does the ambient light, depending on vehicle equipment. In addition, a warning tone sounds.

There is a risk of collision when opening the doors.

## System limits

### General information

Follow the system limits in the "Collision warning systems" chapter.

### Detection range

With the Exit Warning, the following may not be identified in the sensor detection range, e.g.:

- ▷ Fully or partially hidden objects.
- ▷ Stationary or very slow objects.
- ▷ Pedestrians.

### Functional limitations

The Exit Warning may be restricted in the following situations:

- ▷ The speed of an approaching vehicle is too fast or too slow.
- ▷ In curves.
- ▷ In case of fully or partially hidden objects.

## Lane Departure Warning with Lane Return

### Principle

The Lane Departure Warning with Lane Return alerts the driver when their vehicle is about to leave the road or lane.

An automatic steering intervention helps to keep the vehicle in its lane.

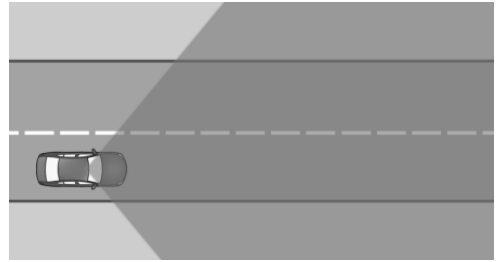

The sensors detect the traffic situation in their detection range.

The Lane Departure Warning can be activated, deactivated and set on the control display.

Various warning functions from this system help the driver keep their vehicle in their lane.

If you set your turn signal for the corresponding direction before leaving your lane, no warnings are displayed.

### Safety information

#### **WARNING**

The system cannot serve as a substitute for the driver's personal judgment in assessing road and traffic situations. There is a risk of accident, injury, and property damage. Adjust driving style to traffic conditions. Watch surrounding traffic closely and actively intervene where appropriate. Do not jerk the steering wheel in response to a warning.

#### **WARNING**

Indicators and warnings cannot serve as a substitute for the driver's personal judgment. Due to its limits, the system may not issue warnings or responses, or these may be issued late or in a manner that is not consistent with their normal use. There is a risk of accident, injury, and property damage. Adjust driving style to traffic conditions. Watch sur-

rounding traffic closely and actively intervene where appropriate.

## Functional requirements

For the Lane Departure Warning to activate, the camera must detect the lane boundary.

## Speed range

The Lane Departure Warning is activated when your vehicle exceeds a given minimum speed. The minimum speed is country-specific and displayed on the control display.

## Sensors

Depending on vehicle equipment, the Lane Departure Warning system is controlled by the following sensors:

- ▶ Camera behind the windshield.
- ▶ Front radar sensor.
- ▶ Side radar sensors, front.

## Activating/deactivating the Lane Departure Warning

### Automatic activation of system

Depending on national-market version, the Lane Departure Warning is automatically activated whenever you start driving.

### Activating the system manually

The Lane Departure Warning is activated by setting the warning time.

Additional information:

Configuring the Lane Departure Warning, refer to page 184.

### Deactivating the system manually

Depending on vehicle equipment and national-market version, you must successively confirm deactivation of the Lane Departure Warning on the control display.

Go through the menu as follows: Apps menu / "Vehicle" / "Driving settings" / "Driver Assistance" / "Safety and warnings" / "Lane Departure Warning" / "Off".

## Setting Lane Departure Warning

The Lane Departure Warning menu can be used to configure this function and specify when it should issue warnings.

1. Go through the menu as follows: Apps menu / "Vehicle" / "Driving settings" / "Driver Assistance" / "Safety and warnings" / "Lane Departure Warning".
2. Select the desired setting.

- ▶ "Expanded"

If the system detects that your vehicle is about to leave your lane or cross a lane marking, a warning is issued. The system performs a steering intervention.

- ▶ "In dangerous situations"

A warning is issued if the system detects that the vehicle is about to inadvertently cross a lane marking, or if the sensors detect an oncoming vehicle. A steering intervention is performed.

Depending on national-market version, with continuous lane markings: If the system detects that your vehicle is about to inadvertently leave your lane or cross a lane marking, a warning is issued. A steering intervention is performed.

## Setting the intensity of the steering wheel vibration

1. To adjust the steering wheel vibration intensity, go through the menu as follows: Apps menu / "Vehicle" / "Driving settings" / "Driver Assistance" / "Feedback via steering wheel" / "Vibration intensity".
2. Select the desired setting.

The setting is applied to all collision warning systems.

## Depending on national-market version: activate/deactivate steering intervention

Depending on national-market version, the Lane Departure Warning steering intervention can be activated or deactivated.

Go through the menu as follows: Apps menu / "Vehicle" / "Driving settings" / "Driver Assistance" / "Safety and warnings" / "Lane Departure Warning" / "Steering intervention".

Depending on the national-market version, the steering intervention is automatically active after every driving off.

## Display in the instrument cluster

Depending on vehicle equipment and national-market version, different warnings are displayed on the instrument cluster for the Lane Departure Warning.

Icon	Meaning
	Indicator light flashes green: System is actively issuing a warning. If necessary, the system performs a steering intervention.

Depending on vehicle equipment and national-market version, information for the system is displayed in the Assisted View of the instrument cluster.

Additional information:

Assisted View, refer to page [147](#).

## Warning function

### General information

Different warnings are issued by the Lane Departure Warning system, depending on situation and speed:

- ▷ Indicator lights and warning lights on the instrument cluster.
- ▷ Vibration of steering wheel.

- ▷ Steering intervention.
- ▷ Warning tone.

### Steering wheel vibration

If you leave the lane and if a lane boundary has been detected, the steering wheel vibrates in accordance with the steering wheel vibration setting.

Additionally, a light is displayed on the instrument cluster.

When the turn signal is switched on in the corresponding direction before changing the lane, a warning is not issued.

### Steering intervention

Depending on vehicle equipment and national-market version: The Lane Departure Warning system may intervene with an active steering intervention in addition to vibration if you cross a lane boundary at speeds up to 130 mph/210 km/h. The system supports the driver in keeping the vehicle within the lane. The steering intervention can be noticed on the steering wheel and can be manually overridden at any time.

During an active steering intervention, a light is displayed on the instrument cluster.

For instance, the steering intervention will be suppressed in the following situations:

- ▷ With hard accelerating or braking.
- ▷ When flashing.
- ▷ With hazard warning system switched on.
- ▷ In driving situation with high driving dynamics.
- ▷ While Dynamic Stability Control regulates driving stability.
- ▷ While Dynamic Stability Control is limited.
- ▷ Immediately following a steering intervention by the vehicle systems.

## End of warning

The warning or active steering intervention of the Lane Departure Warning will be canceled in the following situations, for example:

- ▷ Automatically after a few seconds.
- ▷ When returning to your own lane.
- ▷ With hard accelerating or braking.
- ▷ With hazard warning system switched on.
- ▷ When flashing.
- ▷ While Dynamic Stability Control regulates driving stability.
- ▷ Immediately following a steering intervention by the vehicle systems.
- ▷ With manual steering intervention.
- ▷ When another driver assistance system is activated, if applicable.
- ▷ When no lane boundaries are detected.
- ▷ When the system limits are reached.

## Warning signal

A warning tone sounds if the driver does not actively steer after the Lane Departure Warning system has performed multiple active steering interventions within one minute.

In addition, a Check Control message is displayed.

The warning tone and Check Control message advise the driver to pay closer attention to their lane.

The longer warning tone is stopped if the driver takes control of the steering.

## System limits

### General information

Follow the system limits in the "Collision warning systems" chapter.

### Functional limitations

The Lane Departure Warning system may be restricted in the following situations:

- ▷ In the event of missing, worn, poorly visible, merging, diverging, or multiple lane boundaries such as in construction areas.
- ▷ With lane boundaries that are covered in snow, ice, dirt or water.
- ▷ In tight corners or on narrow roads.
- ▷ With lane boundaries that are covered by objects.
- ▷ When driving very close to the vehicle in front of you.
- ▷ Up to 10 seconds after turning on drive-ready state using the Start/Stop button.
- ▷ While Dynamic Stability Control regulates driving stability.
- ▷ While Dynamic Stability Control is restricted or disabled.

A Check Control message may be displayed on the instrument cluster when this system is not functioning properly. A yellow warning light also illuminates on the instrument cluster, depending on national-market version.

## Active Blind Spot Detection with active return

### Principle

The Active Blind Spot Detection with active return detects vehicles in your blind spot or vehicles approaching from behind in the adjacent lane.

Objects are also detected when turning, depending on vehicle equipment.

An automatic steering intervention helps to keep the vehicle in its lane.

A possible risk of collision is indicated by various warnings, e.g., signaled by warning light on the exterior mirror.

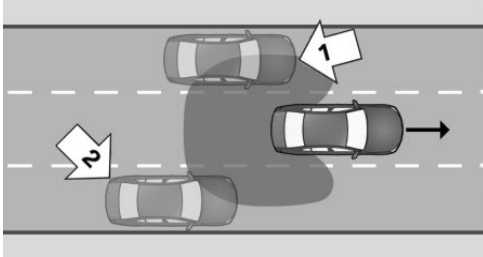

The sensors monitor the area behind and next to the vehicle.

The system indicates whether there are vehicles in your blind spot, arrow 1, or approaching from behind in an adjacent lane, arrow 2. The warning light in the exterior mirror illuminates dimly.

The system will warn in the previously named situations prior to a lane change. The warning light in the exterior mirror flashes. When changing lanes, the steering wheel also vibrates at the set intensity.

Active Blind Spot Detection can be activated, deactivated, and configured on the control display.

## Safety information

### WARNING

The system cannot serve as a substitute for the driver's personal judgment in assessing the traffic situation. Based on the limits of the system, it cannot independently react to all traffic situations. There is a risk of accident, injury, and property damage. Adjust driving style to traffic conditions. Watch the surrounding traffic situation closely, be ready to take over steering and braking at any time, and actively intervene where appropriate.

### WARNING

Indicators and warnings cannot serve as a substitute for the driver's personal judgment. Due to its limits, the system may not issue warnings or responses, or these may be issued late or in a manner that is not consistent with their normal use. There is a risk of accident, injury, and property damage. Adjust driving style to traffic conditions. Watch surrounding traffic closely and actively intervene where appropriate.

## Sensors

Active Blind Spot Detection is controlled by the following sensors:

- ▶ Camera behind the windshield.
- ▶ Side radar sensors, rear.
- ▶ Depending on whether vehicle is equipped with side front radar sensors.

## Speed range

Active Blind Spot Detection is activated when your vehicle exceeds a given minimum speed. The minimum speed is country-specific and displayed in the Active Blind Spot Detection menu.

When turning at a speed of up to approx. 12 mph/20 km/h, the steering wheel will not vibrate.

This system is temporarily deactivated at speeds greater than approx. 155 mph/250 km/h.

If the vehicle speed falls below approx. 155 mph/250 km/h, the system is reactivated.

## Activating/deactivating the Active Blind Spot Detection

1. To activate/deactivate Active Blind Spot Detection, go through the menu as follows: Apps menu / "Vehicle" / "Driving

settings" / "Driver Assistance" / "Safety and warnings" / "Active Blind Spot Detection".

2. Select the desired setting.

Depending on vehicle equipment and national-market version, Active Blind Spot Detection activates automatically whenever you start driving.

## Adjusting the Active Blind Spot Detection

1. To configure Active Blind Spot Detection, go through the menu as follows: Apps menu / "Vehicle" / "Driving settings" / "Driver Assistance" / "Safety and warnings" / "Active Blind Spot Detection".
2. Select the desired setting.

You can configure how many warnings will be shown. However, there may also be an excess of unwarranted warnings of critical situations.

## Setting the intensity of the steering wheel vibration

1. To adjust the steering wheel vibration intensity, go through the menu as follows: Apps menu / "Vehicle" / "Driving settings" / "Driver Assistance" / "Feedback via steering wheel" / "Vibration intensity".
2. Select the desired setting.

The setting is applied to all collision warning systems.

## Depending on national-market version: activate/deactivate steering intervention

Depending on national-market version, the Active Blind Spot Detection steering intervention can be activated or deactivated.

Go through the menu as follows: Apps menu / "Vehicle" / "Driving settings" / "Driver Assistance" / "Safety and warnings" / "Active Blind Spot Detection" / "Steering intervention".

## Activating/deactivating the Turn Warning

Objects in your blind spot are detected when turning at low speed, depending on vehicle equipment.

To activate/deactivate the Turn Warning, go through the menu as follows: Apps menu / "Vehicle" / "Driving settings" / "Driver Assistance" / "Safety and warnings" / "Active Blind Spot Detection" / "Warning when turning".

## Warning function

### Warning light in exterior mirror



The warning light in the exterior mirror warns of a possible collision with a detected vehicle.

## Prewarning

In the event of a prewarning for Active Blind Spot Detection, the dimmed warning light on the exterior mirror indicates when vehicles are in your blind spot or approaching from the rear.

## Acute warning

When an acute warning is issued by Active Blind Spot Detection, the steering wheel vibrates briefly. The warning light in the exterior mirror flashes brightly.

An acute warning is issued if the following conditions are met:

- ▷ Another vehicle is located in the critical area.
- ▷ Your own vehicle is approaching the other lane.
- ▷ Depending on the system setting when the turn signal is turned on.

The warning stops when the other vehicle has left the critical area.

## Steering intervention

Depending on national-market version: The Active Blind Spot Detection system may perform an active steering intervention when there is no response to the steering wheel vibration and a lane boundary is crossed at speeds of up to 130 mph/210 km/h. The steering intervention helps return the vehicle into the lane. The steering intervention can be noticed on the steering wheel and can be manually overridden at any time.

The steering intervention is carried out from a minimum speed. The minimum speed is displayed on the control display.

## Warning light flashing

As a self-test of Active Blind Spot Detection, the warning light on the exterior mirror flashes briefly when the vehicle is unlocked.

## System limits

### General information

Follow the system limits in the "Collision warning systems" chapter.

### Functional limitations

The Active Blind Spot Detection may be restricted in the following situations:

- ▷ When a vehicle is approaching at a speed much faster than your own.
- ▷ In tight corners or on narrow roads.
- ▷ The bumper is dirty, iced up or covered, for instance by stickers.

Depending on the national-market version, the steering intervention e.g. in the following situations:

- ▷ In the event of missing, worn, poorly visible, merging, diverging, or multiple lane boundaries such as in construction areas.
- ▷ With lane boundaries that are covered in snow, ice, dirt or water.
- ▷ With lane boundaries that are not white.
- ▷ With lane boundaries that are covered by objects.
- ▷ When driving very close to the vehicle in front of you.
- ▷ If the camera is impaired.
- ▷ Up to 10 seconds after turning on drive-ready state using the Start/Stop button.

A Check Control message may be displayed on the instrument cluster when this system is not functioning properly. A yellow warning light also illuminates on the instrument cluster, depending on national-market version.

## Side Collision Protection

### Principle

The Side Collision Protection helps to avoid an impending side collision.

If, for example, another vehicle is detected next to your vehicle and there is a risk of collision with this vehicle, the system helps avoid a collision. The system warns the driver by flashing the warning light on the exterior mirror, issuing a Check Control message, and vibrating the steering wheel.

If necessary, an active steering intervention is performed by the system.

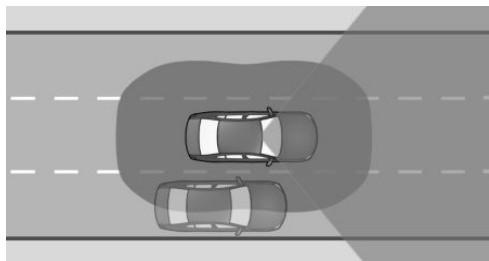

The sensors monitor the space next to the vehicle.

The Side Collision Protection can be activated or deactivated on the control display. The severity of the steering wheel vibration can be adjusted.

## Safety information

### WARNING

The system cannot serve as a substitute for the driver's personal judgment in assessing the traffic situation. Based on the limits of the system, it cannot independently react to all traffic situations. There is a risk of accident, injury, and property damage. Adjust driving style to traffic conditions. Watch the surrounding traffic situation closely, be ready to take over steering and braking at any time, and actively intervene where appropriate.

### WARNING

Indicators and warnings cannot serve as a substitute for the driver's personal judgment. Due to its limits, the system may not issue warnings or responses, or these may be issued late or in a manner that is not consistent with their normal use. There is a risk of accident, injury, and property damage. Adjust driving style to traffic conditions. Watch surrounding traffic closely and actively intervene where appropriate.

## Functional requirements

The camera behind the windshield determines the lane boundary positions.

For the Side Collision Protection with steering intervention to activate, the camera must detect the lane boundary.

## Speed range

The Side Collision Protection is activated when your vehicle exceeds a given minimum speed. The minimum speed is country-specific and displayed on the control display.

This system responds when your vehicle speed is less than approx. 130 mph/210 km/h.

## Sensors

The Side Collision Protection is controlled by the following sensors:

- ▷ Camera behind the windshield.
- ▷ Side radar sensors, front.
- ▷ Side radar sensors, rear.

## Activating/deactivating the Side Collision Protection

1. To activate/deactivate the Side Collision Protection, go through the menu as follows: Apps menu / "Vehicle" / "Driving settings" / "Driver Assistance" / "Safety and warnings" / "Side Collision Protection".
2. Select the desired setting.

## Setting the intensity of the steering wheel vibration

1. To adjust the steering wheel vibration intensity, go through the menu as follows: Apps menu / "Vehicle" / "Driving settings" / "Driver Assistance" / "Feedback via steering wheel" / "Vibration intensity".
2. Select the desired setting.

The setting is applied to all collision warning systems.

## Display in the instrument cluster

Depending on vehicle equipment and national-market version, Side Collision Protection information is displayed in the Assisted View on the instrument cluster.

Additional information:

Assisted View, refer to page 147.

## Warning function

### Warning light in exterior mirror



The warning light in the exterior mirror warns of a possible collision with a detected vehicle.

### Acute warning

In the event of an acute warning of the Side Collision Protection, the warning light on the exterior mirror flashes and the steering wheel begins to vibrate if there is a risk of collision.

A Check Control message is displayed on the instrument cluster at the same time.

### Steering intervention

Depending on the national-market version, if necessary, the system engages the active steering intervention to prevent a collision and maintain the vehicle within its own lane. The steering intervention can be noticed on the steering wheel and can be manually overridden at any time.

## System limits

### General information

Follow the system limits in the "Collision warning systems" chapter.

### Functional limitations

The Side Collision Protection may be restricted in the following situations:

- ▷ In tight corners or on narrow roads.
- ▷ In the event of missing, worn, poorly visible, merging, diverging, or multiple lane boundaries such as in construction areas.
- ▷ With lane boundaries that are covered in snow, ice, dirt or water.
- ▷ With lane boundaries that are not white.
- ▷ With lane boundaries that are covered by objects.
- ▷ When driving very close to the vehicle in front of you.
- ▷ Up to 10 seconds after turning on drive-ready state using the Start/Stop button.

A Check Control message may be displayed on the instrument cluster when this system is not functioning properly.

## Rear-End Collision Preparation

### Principle

Depending on the equipment and national-market version, the Rear-End Collision Preparation can react to vehicles approaching from behind.

Depending on national-market version, the hazard warning system turns on and PreCrash functions may be triggered if a vehicle is detected approaching at a certain speed.

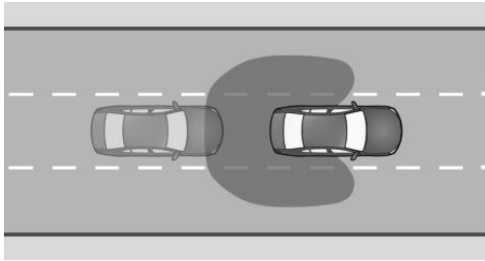

The sensors monitor the area behind the vehicle.

The Rear-End Collision Preparation is activated automatically when you start driving and is deactivated automatically in certain situations.

## Safety information

### WARNING

The system cannot serve as a substitute for the driver's personal judgment in assessing the traffic situation. Based on the limits of the system, it cannot independently react to all traffic situations. There is a risk of accident, injury, and property damage. Adjust driving style to traffic conditions. Watch the surrounding traffic situation closely, be ready to take over steering and braking at any time, and actively intervene where appropriate.

### WARNING

Indicators and warnings cannot serve as a substitute for the driver's personal judgment. Due to its limits, the system may not issue warnings or responses, or these may be issued late or in a manner that is not consistent with their normal use. There is a risk of accident, injury, and property damage. Adjust driving style to traffic conditions. Watch surrounding traffic closely and actively intervene where appropriate.

## Sensors

The Rear-End Collision Preparation is controlled by the side, rear radar sensors.

## Activating/deactivating the Rear-End Collision Preparation

The Rear-End Collision Preparation is automatically activated whenever you start driving.

The system is deactivated when reversing.

## System limits

### General information

Follow the system limits in the "Collision warning systems" chapter.

### Functional limitations

The Rear-End Collision Preparation may be restricted if the speed of the approaching vehicle is much higher or similar to your own speed.

## Traffic Light and Sign Warning

### Principle

The Traffic Light and Sign Warning provides support in situations in which the right-of-way needs to be yielded based on road signs or traffic lights.

This system uses a camera to analyze traffic signs and traffic lights. The navigation system directs information on the road layout to the system.

For warning purposes, the respective traffic situation, for example, is displayed on the instrument cluster. An acoustic signal also sounds in acute warning situations.

A warning is given if the right of way is about to be violated, e.g., in the following traffic situations:

- ▷ At an intersection.
- ▷ At a road entrance.
- ▷ On a highway entrance ramp.
- ▷ At a roundabout.
- ▷ With a red traffic light.

The Traffic Light and Sign Warning can be activated or deactivated on the control display. You can also configure the warning time.

## Safety information

### **WARNING**

The system cannot serve as a substitute for the driver's personal judgment in assessing the traffic situation. Based on the limits of the system, it cannot independently react to all traffic situations. There is a risk of accident, injury, and property damage. Adjust driving style to traffic conditions. Watch the surrounding traffic situation closely, be ready to take over steering and braking at any time, and actively intervene where appropriate.

### **WARNING**



Indicators and warnings cannot serve as a substitute for the driver's personal judgment. Due to its limits, the system may not issue warnings or responses, or these may be issued late or in a manner that is not consistent with their normal use. There is a risk of accident, injury, and property damage. Adjust driving style to traffic conditions. Watch surrounding traffic closely and actively intervene where appropriate.

## Functional requirements

The right-of-way situation ahead of the vehicle must be clearly controlled by traffic signs or light signal systems.

## Identifiable right-of-way situations

Various traffic signs are taken into account for the Traffic Light and Sign Warning:

Sign	Meaning
	Give way signs: A pre-warning is issued for these road signs.
	Stop signs: A pre-warning is issued for these road signs.
	When traffic lights are red, a pre-warning and an acute warning will be issued.

## Speed range

The Traffic Light and Sign Warning issues a warning as from a variable minimum speed and at speeds up to approx. 60 mph/100 km/h.

## Sensors

The Traffic Light and Sign Warning is controlled by the camera behind the windshield.

## Activating/deactivating the Traffic Light and Sign Warning

1. To activate/deactivate the Traffic Light and Sign Warning, go through the menu as follows: Apps menu / "Vehicle" / "Driving settings" / "Driver Assistance" / "Safety and warnings" / "Traffic Light and Sign Warning".
2. Select the desired setting.

## Setting the warning time for the Traffic Light and Sign Warning

1. To configure the warning time for the Traffic Light and Sign Warning, go through the menu as follows: Apps menu / "Vehicle" / "Driving settings" / "Driver Assistance" /

"Safety and warnings" / "Traffic Light and Sign Warning".

2. Select the desired setting.

The selected setting is saved and adopted for the next journey.

## Warning function

### General information

The Traffic Light and Sign Warning issues warnings in two levels.



In the event of a prewarning, the system issues a warning by means of an icon on the instrument cluster.

In the event of an acute warning, the system issues a warning by displaying an icon on the instrument cluster and sounding an acoustic signal.

The timing of the warning varies with the actual driving situation and the warning time setting.

### Prewarning

If a prewarning is issued for the Traffic Light and Sign Warning because there is a risk that a vehicle is not yielding the right-of-way, an icon is displayed on the instrument cluster:

Icon	Meaning
	Give way.
	Stop.
	Red traffic light.

When a prewarning is issued, intervene as appropriate for the situation; for example, by braking.

### Acute warning

If an acute warning is issued for the Traffic Light and Sign Warning because there is a risk that a vehicle is not yielding the right-of-way, a signal tone sounds and an icon is displayed on the instrument cluster:

Icon	Meaning
	Red traffic light.

When an acute warning is issued, intervene as appropriate for the situation; for example, by braking.

### Display in the Head-up display

Depending on vehicle equipment, the Traffic Light and Sign Warning is displayed simultaneously on the Head-up display and instrument cluster.

### System limits

#### General information

Follow the system limits in the "Collision warning systems" chapter.

#### No warning

The Traffic Light and Sign Warning does not issue a warning in the following situations, for example:

- ▶ In right-of-way situations without right-of-way signs, stop signs, or red light signal systems.
- ▶ With intersections with relevant traffic lights that are illuminated yellow or green.

#### Functional limitations

The Traffic Light And Sign Warning system may be limited in the following situations:

- ▷ If road signs or light signal systems are unclear.
- ▷ If traffic signs or light signal systems are fully or partially concealed or soiled.
- ▷ If traffic signs or light signal systems are difficult to read or rotated.
- ▷ If traffic signs or light signal systems are too small or too large.
- ▷ If the traffic signs do not correspond to the standard.
- ▷ When traffic signs are detected that apply to a junction or parallel street.
- ▷ In the presence of country-specific road signs or road layouts.
- ▷ With intersections with flashing light signal systems.
- ▷ Up to 10 seconds after turning on drive-ready state using the Start/Stop button.
- ▷ In the case of navigation data that is invalid, outdated or not available.
- ▷ In some regions, the system may not be available or only partially available.

## Wrong Way Warning

### Principle

The Wrong Way Warning warns the driver of an upcoming wrong entry onto roads, for instance onto freeways, roundabouts and one-way streets.

The system uses sensors and, depending on vehicle equipment, navigation data and traffic signs to monitor the traffic situation.

For warning purposes, a corresponding traffic sign is displayed on the instrument cluster and an acoustic signal sounds.

## Safety information

### WARNING

The system cannot serve as a substitute for the driver's personal judgment in assessing the traffic situation. Based on the limits of the system, it cannot independently react to all traffic situations. There is a risk of accident, injury, and property damage. Adjust driving style to traffic conditions. Watch the surrounding traffic situation closely, be ready to take over steering and braking at any time, and actively intervene where appropriate.

### WARNING

Indicators and warnings cannot serve as a substitute for the driver's personal judgment. Due to its limits, the system may not issue warnings or responses, or these may be issued late or in a manner that is not consistent with their normal use. There is a risk of accident, injury, and property damage. Adjust driving style to traffic conditions. Watch surrounding traffic closely and actively intervene where appropriate.

## Functional requirements

The road layout ahead must be controlled clearly with traffic signs.

### Identifiable traffic situations

The Wrong Way Warning system recognizes the following traffic signs, for example:

- ▷ No entrance.
- ▷ Roundabout.
- ▷ Direction arrows for required passing maneuver.

## Sensors

The Wrong Way Warning function is controlled by the camera behind the windshield.

## Enabling the Wrong Way Warning

Depending on national-market version, the Wrong Way Warning is automatically activated whenever you start driving.

### Warning function



The Wrong Way Warning is displayed and an acoustic signal sounds when your vehicle is traveling in the wrong direction on a highway, roundabout, or one-way street, for example.

Warnings are displayed on the instrument cluster and, depending on vehicle equipment, on the Head-up display.

### System limits

#### General information

Follow the system limits in the "Collision warning systems" chapter.

#### No warning

For example, the Wrong Way Warning does not issue warnings for roadways without traffic signs.

#### Functional limitations

The Wrong Way Warning may be restricted in the following situations, for example, and will either output an incorrect wrong way warning or no warning at all:

- ▶ When the signage is not clear.
- ▶ If the traffic signs are fully or partially concealed or soiled.
- ▶ If the traffic signs are poorly legible or rotated.
- ▶ If the traffic signs are too small or too large.
- ▶ If the traffic signs do not correspond to the standard.
- ▶ When traffic signs are detected that apply to a junction or parallel street.

- ▶ In the presence of country-specific road signs or road layouts.
- ▶ Up to 10 seconds after turning on drive-ready state using the Start/Stop button.
- ▶ In the case of navigation data that is invalid, outdated or not available.
- ▶ It may not be possible to use the system in all regions.

## No Turn on Red Information

### Principle

The No Turn on Red Information assists the driver by indicating at which traffic lights turning on red is prohibited.

To do so, this function analyzes traffic lights and traffic signs using the camera behind the windshield. In addition, the navigation system data is used.

### Safety information

#### WARNING

The system cannot serve as a substitute for the driver's personal judgment in assessing the traffic situation. Based on the limits of the system, it cannot independently react to all traffic situations. There is a risk of accident, injury, and property damage. Adjust driving style to traffic conditions. Watch the surrounding traffic situation closely, be ready to take over steering and braking at any time, and actively intervene where appropriate.

#### WARNING

Indicators and warnings cannot serve as a substitute for the driver's personal judgment. Due to its limits, the system may not issue warnings or responses, or these may be issued late or in a manner that is not consistent with their normal use. There is a risk of

accident, injury, and property damage. Adjust driving style to traffic conditions. Watch surrounding traffic closely and actively intervene where appropriate.

## Functional requirements

To use the No Turn on Red Information function, the following functional requirements must be met:

- ▶ The system detects the right-of-way situation ahead by analyzing traffic lights and traffic signs.
- ▶ Vehicle is less than approx. 164 ft/50 m from the traffic lights.
- ▶ Depending on vehicle equipment, the Traffic Light and Sign Warning is activated.

## Sensors

The No Turn on Red Information is controlled by the camera behind the windshield.

## Display in the instrument cluster



If the driver approaches a red traffic light with a traffic sign that prohibits a turn on red, an indicator light is displayed on the instrument cluster.

The indicator light goes out automatically after you drive off at a speed greater than approx. 9 mph/15 km/h.

## System limits

### General information

Follow the system limits in the "Collision warning systems" chapter.

### Functional limitations

The No Turn on Red Information may be limited in the following situations, for example:

- ▶ If road signs or light signal systems are unclear.
- ▶ If traffic signs or light signal systems are fully or partially concealed or soiled.
- ▶ If traffic signs or light signal systems are difficult to read or rotated.
- ▶ If traffic signs or light signal systems are too small or too large.
- ▶ If the traffic signs do not correspond to the standard.
- ▶ With intersections with flashing light signal systems.
- ▶ In the case of navigation data that is invalid, outdated or not available.
- ▶ In some regions, this function may not be completely available or not available at all.

## Emergency Stop Assistant

### Principle

The Emergency Stop Assistant assists the driver if they are no longer able to drive their vehicle safely. When the system is triggered, the vehicle is brought to a stop in its own lane by the lane keeping system.

Triggering of the Emergency Stop Assistant can be enabled or disabled on the control display.

The driver can manually cancel the Emergency Stop Assistant at any time.

### Safety information

#### **WARNING**

The system cannot serve as a substitute for the driver's personal judgment in assessing one's physical state. An increasing lack of alertness or fatigue may not be detected or not be detected in time. There is a risk of accident, injury, and property damage. Make

sure that the driver is rested and alert. Adjust driving style to traffic conditions.

## Functional requirements

To use the Emergency Stop Assistant, the following functional requirements must be met:

- ▷ The Emergency Stop Assistant is activated via iDrive.
- ▷ The system is activated from a speed of approx. 43 mph/70 km/h.
- ▷ The Driver Attention Camera detects driver activity.

## Activating/deactivating Emergency Stop Assistant

To activate/deactivate triggering of the Emergency Stop Assistant, go through the menu as follows: Apps menu / "Vehicle" / "Driving settings" / "Driver Assistance" / "Safety and warnings" / "Fatigue Alert" / "Emergency stop".

## Triggering the Emergency Stop Assistant

If the Emergency Stop Assistant detects that the driver is no longer driving their vehicle safely or is ignoring warnings, the system is triggered automatically. The triggered system is displayed in the instrument cluster.

An immediate emergency call can be triggered on the control display.

The following is performed automatically when the Emergency Stop Assistant is triggered:

- ▷ A display is shown on the instrument cluster.
- ▷ This system maneuvers the vehicle until it comes to a standstill.
- ▷ The hazard warning system is switched on.

- ▷ An emergency call is triggered when stationary, depending on vehicle equipment.
- ▷ The Head-up display may turn off while an emergency call is ongoing.

The Emergency Stop Assistant can also be triggered via voice input.

Additional information:

BMW Intelligent Personal Assistant, refer to page 50.

## Canceling Emergency Stop Assistant

The driver can cancel the Emergency Stop Assistant at any point by taking active control of driving the vehicle.

The system is stopped by the following actions, for example:

- ▷ By firmly pressing the accelerator pedal.
- ▷ By stopping the system on the control display.
- ▷ By operating the turn signal.
- ▷ By turning off the hazard warning system.
- ▷ By firmly countersteering.
- ▷ By changing the selector lever position when the vehicle was already at a standstill.

## At standstill

As soon as the vehicle is stationary, the Emergency Stop Assistant will apply the following settings:

- ▷ The vehicle is secured against rolling away.
- ▷ The interior lights are switched on.
- ▷ The central locking system is unlocked.

## Display in the instrument cluster

When triggered, the Emergency Stop Assistant is shown on the instrument cluster.

Icon	Meaning
	The Emergency Stop Assistant has triggered.

## System limits

The Emergency Stop Assistant does not release the driver from their obligation to drive safely in traffic.

This system may be restricted in the following situations:

- ▶ When the Driver Attention Camera is covered by the steering wheel.
- ▶ When wearing sunglasses with high protection against infrared light.

## Cross Traffic Warning with brake intervention

### Principle

The Cross Traffic Warning with brake intervention helps the driver by providing visual and acoustic warnings when driving through confusing exits or pulling out of perpendicular parking spaces.

The system detects road users approaching from the side earlier than would be possible from the driver's seat.

If there is a risk of collision when reversing, this system provides assistance by performing an automatic brake intervention.

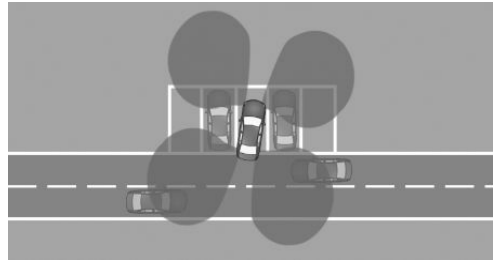

The sensors monitor the area behind the vehicle.

Depending on the vehicle equipment, the area around the vehicle in front of the vehicle is monitored as well.

The system displays a warning light on the exterior mirror, for example, when other road users are approaching.

The Cross Traffic Warning can be activated or deactivated on the control display.

In addition, note the information in Chapter "Parking assistance systems".

Additional information:

Parking assistance systems, refer to page [239](#).

### Safety information

#### WARNING

The system cannot serve as a substitute for the driver's personal judgment in assessing the traffic situation. Based on the limits of the system, it cannot independently react to all traffic situations. There is a risk of accident, injury, and property damage. Adjust driving style to traffic conditions. Watch the surrounding traffic situation closely, be ready to take over steering and braking at any time, and actively intervene where appropriate.

### Sensors

The Cross Traffic Warning is controlled by the following sensors:

- ▷ Side radar sensors, rear.
- ▷ Depending on whether vehicle is equipped with side front radar sensors.

## Activating/deactivating Cross Traffic Warning

The system must be activated on the control display for the Cross Traffic Warning and brake intervention to switch on automatically.

1. Go through the menu as follows: Apps menu / "Vehicle" / "Driving settings" / "Driver Assistance" / "Parking".
2. Select the desired setting, depending on vehicle equipment:
  - ▷ "Rear warning"
  - ▷ "Front and rear warning"
  - ▷ "Brake intervention at rear"

## Turning on the cross traffic warning automatically

The cross traffic warning must be activated on the control display. The system turns on automatically as soon as Park Distance Control or camera view activates and you engage a gear position.

If reverse gear is engaged, the rear system is switched on.

Depending on the equipment, the front system is turned on when a gear position is engaged.

Depending on the national-market version, the system is automatically active when the vehicle is started.

## Turning off the cross traffic warning automatically

The Cross Traffic Warning switches off automatically in the following situations, for example:

- ▷ When walking speed is exceeded.
- ▷ When a certain distance covered is exceeded.

## Warning function

### General information

With the Cross Traffic Warning, the control display shows the corresponding view, an acoustic signal may sound, and the warning light on the exterior mirror flashes.

In case of a brake intervention, a message is displayed on the control display and close after a brief period of time.

### Visual warning

#### Warning light in exterior mirror



The warning light in the exterior mirror flashes if the rear sensors detect other vehicles when the vehicle is reversing.

#### Display in the Park Distance Control view

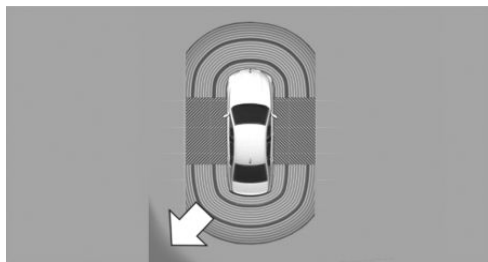

In the Park Distance Control view, the respective boundary area flashes red if vehicles are detected by the sensors.

## Display in camera view

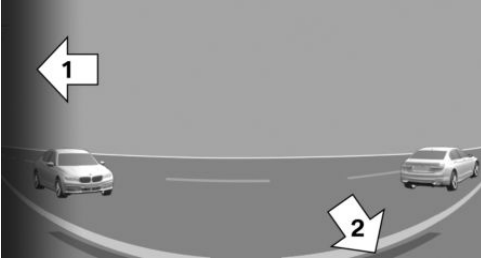

Depending on the direction of travel, the view to the front or back is displayed in the camera image.

The boundary area in the camera image flashes red if vehicles are detected by the sensors, arrow 1.

Yellow lines mark the bumper of your own vehicle, arrow 2.

## Acoustic warning

In addition to the visual warning of the Cross Traffic Warning function, an acoustic signal sounds if your vehicle moves in the corresponding direction.

Depending on the national-market version, the signal tone will already sound when the gear position is engaged.

## System limits

### System limits of the sensors

The Cross Traffic Warning may be restricted by the system limits of the sensors.

Additional information:

Sensors of the vehicle, refer to page 34.

### Functional limitations

The Cross Traffic Warning system may be restricted in the following situations:

- ▷ In tight curves.
- ▷ Crossing objects are moving at a very slow or a very fast speed.
- ▷ Other objects that hide cross traffic are in the capture range of the sensors.

## BMW Drive Recorder

### Principle

The BMW Drive Recorder stores brief video recordings of the vehicle surroundings, e.g., to document surrounding traffic. This system must be activated on the control display before it can be used for the first time.

The control display can be used to configure video recording settings like the recording type and time, e.g., for an accident.

Video recordings can be saved in different ways:

- ▷ Automatic storage of recordings makes it possible to document the vehicle accident or theft using the corresponding recording type configured.
- ▷ Saving recordings manually helps you document traffic situations using your set recording type.

Depending on vehicle equipment, video recordings can be saved directly to a mobile device, e.g., smartphone.

Recordings can be played on the control display.

Assistance system cameras are used to record, e.g., panorama view cameras.

In addition, the following parameters are stored for the trip:

- ▷ Date.
- ▷ Time.
- ▷ Speed.
- ▷ GPS coordinates.

## Vehicle features and options

This system may not be available in the owned vehicle, e.g. due to the selected optional equipment, the national-market version or the option for later enabling and software updates. This also applies to individual functions of the system.

For information on whether a function is currently available in the vehicle or when the function can be installed in the vehicle, contact an authorized service center or another qualified service center or repair shop.

Additional information:

Vehicle equipment, refer to page 8.

## Data protection

The BMW Drive Recorder is permitted to record and evaluate video recordings in accordance with the statutory regulations of the country in which the system is to be used. The user is responsible for the use of the system and compliance with respective applicable regulations.

The vehicle manufacturer recommends that you verify there are no statutory or regulatory restrictions on using the system in your region or country prior to initial use. In addition, the laws with respect to use of the system should be verified in regular intervals, especially when borders are frequently crossed.

Other drivers of the vehicle must be informed about the system. In addition, you should inform others about the system when giving them the vehicle.

## Functional requirements

To use the BMW Drive Recorder, the following functional requirements must be met:

- ▶ Standby or drive-ready state is on.
- ▶ The BMW Drive Recorder is activated.
- ▶ The Privacy Policy has been accepted.

- ▶ Depending on vehicle equipment, the use of cameras and GPS coordinates has been accepted in the Privacy menu.
- ▶ The recording type has been selected.
- ▶ The recording duration has been selected.

To use the Theft Alert, the following functional requirements must be met:

- ▶ The theft notification was activated in the Data Protection menu or in the Drive Recorder menu.
- ▶ Data transfer is activated.
- ▶ The My BMW App is installed on the mobile device.
- ▶ The My BMW app is linked to the ConnectedDrive account.
- ▶ The Privacy Policy has been accepted.

## Activating/deactivating the BMW Drive Recorder

You must activate the BMW Drive Recorder on the control display before using the recording function for the first time.

1. Go through the menu as follows: Apps menu / "All" / "Drive Recorder".
2. Accept the Privacy Policy.
3. "Settings"
4. "Allow recordings"
5. Select the desired setting.

## Recording functions

### Starting/stopping an automatic recording

If the vehicle sensors detect an accident or theft, the BMW Drive Recorder starts recording automatically and then saves this recording.

- ▶ In the event of an accident, the BMW Drive Recorder saves recordings up to 30 seconds before and after storage is triggered.
- ▶ In the event of theft, the BMW Drive Recorder saves recordings after being trig-

gered. Recordings are stored depending on the setting selected for recording duration.

When the alarm system is triggered, a message is sent to the My BMW App.

After saving the recording, the reduced quality video can be downloaded to a mobile device.

If the vehicle accelerates rapidly, an automatic recording may be taken.

## Starting/stopping manual recording

### Using the button

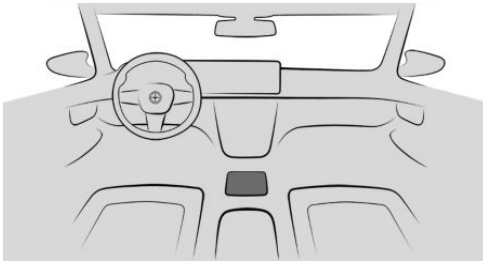

 To start a manual recording with the BMW Drive Recorder, press and hold the parking assistance button on the center console.

Recordings are made for the set recording duration or can be ended manually on the control display.

### Via iDrive

To start recording with BMW Drive Recorder in the vehicle, go through the menu as follows: Apps menu / "All" / "Drive Recorder" / "Start recording" / "Vehicle".

Recordings are made for the set recording duration and can be stopped manually by reselecting the menu item on the control display.

The system saves recordings up to 30 seconds before and after storage is triggered.

## Recording playback and administration

Video recordings saved by the BMW Drive Recorder can be played, exported, and deleted.

For your own safety, video recordings are only shown on the control display if the vehicle speed is below approx. 2 mph/3 km/h. Depending on national-market version, video recordings are only shown when the parking brake is applied or selector lever position P is engaged.

1. Go through the menu as follows: Apps menu / "All" / "Drive Recorder" / "Recordings".
2. Select the desired recording.
3. If necessary, select the camera.

## Settings

### Recording type

1. To select the recording type for BMW Drive Recorder, go through the menu as follows: Apps menu / "All" / "Drive Recorder" / "Settings".
2. Select the desired setting.

### Recording time

1. To configure the recording time for BMW Drive Recorder, go through the menu as follows: Apps menu / "All" / "Drive Recorder" / "Settings".
2. Select the desired setting.

## Recording on a mobile device

### General information

Depending on national-market version, recordings can be saved to a mobile device.

The length of the video that can be stored depends on the available memory capacity on the mobile device.

## Functional requirements

To record on a mobile device, the following functional requirements for the BMW Drive Recorder must be met:

- ▷ The Privacy Policy has been accepted.
- ▷ The BMW Drive Recorder is activated.

To send recordings to a mobile device, the following functional requirements for the BMW Drive Recorder must be met:

- ▷ Depending on vehicle equipment, a mobile device can be paired with the vehicle over Wi-Fi and Bluetooth audio.
- ▷ The My BMW App is installed and open on the mobile device.
- ▷ A BMW ID is linked to a ConnectedDrive account in the vehicle and the My BMW App.
- ▷ The My BMW App is permitted to access your photo library.
- ▷ The mobile device is placed close to the center console.

## Starting/ending recording

To start recording with BMW Drive Recorder on a mobile device, go through the menu as follows: Apps menu / "All" / "Drive Recorder" / "Start recording" / "(My BMW App)".

Recordings can be stopped manually by selecting the menu item on the control display.

## Cameras

You can select any camera of the BMW Drive Recorder.

1. Go through the menu as follows: Apps menu / "All" / "Drive Recorder" / "Settings" / "Camera selection".
2. Select your desired camera.

## System limits

In the event of serious accidents, the BMW Drive Recorder may not be able to store recordings if the damage to the vehicle is too great or the power supply was interrupted.

If the accident severity is too low, the BMW Drive Recorder may not save a recording.

In case of theft, recordings are only saved automatically when the alarm system has been triggered.

If the internet connection is weak or cannot be established, theft alerts and video downloads may be restricted or not available.

The BMW Drive Recorder may not work properly if used in parallel with Apple CarPlay or Android Auto on the vehicle Wi-Fi. A corresponding message appears on the control display.

The quality of the Wi-Fi connection affects whether recordings can be saved on your smartphone. This function may be restricted or not available if the connection is weak.

If the mobile device overheats, e.g., when charging in the Wireless Charging tray, the recording system may stop when recording manually or sending a recording.

## Active Protection

### Principle

Active Protection prepares occupants and the vehicle for a possible accident in critical driving situations.

Depending on vehicle equipment and national-market version, Active Protection consists of various PreCrash functions.

Active Protection is used to detect certain critical driving situations that might lead to an accident. The following critical driving situations can occur, for example:

- ▷ Emergency braking.
- ▷ Severe understeering.
- ▷ Severe oversteering.

Certain functions of some vehicle systems can lead to Active Protection being triggered within their system limits:

- ▷ Automatic brake intervention by Forward Collision Mitigation.
- ▷ Brake power assistance provided by Forward Collision Mitigation.
- ▷ Detection of an impending rear collision by the Rear-End Collision Preparation.

## Safety information

### WARNING

The system cannot serve as a substitute for the driver's personal judgment. Due to the system limits, critical situations might not be detected reliably or in time. There is a risk of accident, injury, and property damage. Adjust driving style to traffic conditions. Watch surrounding traffic closely and actively intervene where appropriate.

## PreCrash functions

Depending on vehicle equipment and requirements, Active Protection activates the following individual functions in critical driving situations:

- ▷ Automatic closing of the windows.  
The windows remain open with a small gap.
- ▷ Automatic closing of the glass sunroof.  
The sun protection is also closed.

Systems can be returned to the desired settings following a critical driving situation without accident.

## PostCrash iBrake

### Principle

In certain accident situations, PostCrash iBrake can automatically bring the vehicle to a stop without any need for the driver to intervene. This can reduce the risk of a further collision.

After coming to a halt, the brake is released automatically.

The driver can intervene manually to brake the vehicle more sharply or cancel automatic braking with PostCrash iBrake.

## Harder vehicle deceleration

In certain situations, it may be necessary to bring the vehicle to a stop more quickly than automatic braking with PostCrash iBrake.

Brake quickly and forcefully. The brake pressure will then be higher than the brake pressure generated by automatic braking. Automatic braking with PostCrash iBrake is canceled.

## Abort automatic braking

It may be necessary to cancel PostCrash iBrake automatic braking in certain situations, e.g., when making an evasive maneuver.

Automatic braking can be canceled by doing as follows:

- ▷ By depressing the brake pedal for slightly longer.
- ▷ By pressing the accelerator pedal for slightly longer.

## Fatigue Alert

### Principle

The Fatigue Alert can detect when the driver is less alert using various criteria.

The Fatigue Alert break recommendation function can detect driver fatigue, e.g., during long, monotonous trips. This function recommends taking a break as necessary. A prompt appears on the control display.

The break recommendation can be adjusted on the control display.

## Safety information

### WARNING

The system cannot serve as a substitute for the driver's personal judgment in assessing one's physical state. An increasing lack of alertness or fatigue may not be detected or not be detected in time. There is a risk of accident, injury, and property damage. Make sure that the driver is rested and alert. Adjust driving style to traffic conditions.

## Break recommendation

### Function

The break recommendation begins training to the driver once a trip is started, enabling it to detect when the driver is inattentive or fatigued.

This process takes the following criteria into account:

- ▷ Personal driving style, e.g., steering behavior.
- ▷ Driving conditions, e.g., the time or duration of the drive.
- ▷ Depending on vehicle equipment, information from the Driver Attention Camera.

This function activates at speeds greater than approx. 43 mph/70 km/h and can also display a break recommendation.

### Setting break recommendation

The Distraction Warning from the Fatigue Alert system can be turned on or off or configured.

1. Go through the menu as follows: Apps menu / "Vehicle" / "Driving settings" / "Driver Assistance" / "Safety and warnings" / "Fatigue Alert".
2. Select the desired setting.

Despite this function being off, some driver assistance systems may issue break recommendations.

### Display

If the driver becomes less alert or fatigued, the Fatigue Alert system displays a message on the control display, recommending the driver to take a break.

During the display, various settings can be selected.

The system is reset approx. 45 minutes after parking the vehicle. A break recommendation can only be displayed again after this time has elapsed.

### System limits

The Fatigue Alert system may be limited. If the system is limited, either no warning may be issued or an unwarranted warning may be issued.

The break recommendation may be limited in the following situations:

- ▷ If the time is set incorrectly.
- ▷ At a predominantly driven speed below approx. 43 mph/70 km/h.
- ▷ With a sporty driving style such as during rapid acceleration or when cornering fast.
- ▷ In active driving situations such as when changing lanes frequently.
- ▷ When the road condition is poor.
- ▷ In the event of strong side winds.

## Driver Attention Camera

### Principle

The Driver Attention Camera is a camera on the instrument cluster. The camera monitors the driver's activity and direction of view, depending on vehicle equipment.

The assistance systems help drivers by analyzing whether they are paying attention, e.g., by evaluating their head position and eyes.

## Functional requirements

For full operability, make sure that the field of view of the Driver Attention Camera is not obstructed.

The steering wheel and driver's seat height must be adjusted so that the entire instrument cluster is visible. This enables the Driver Attention Camera to record the driver's entire face.

## Overview

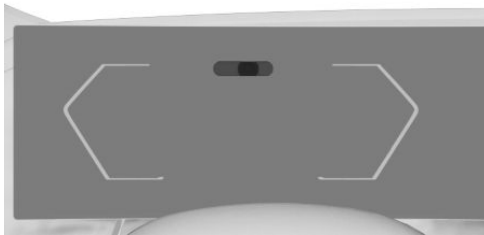

One infrared light source is located on the instrument cluster. Depending on the lighting conditions, these light sources may be visible when the vehicle is in standby.

## System limits

The Driver Attention Camera may not be fully operational in the following situations:

- ▶ When the Driver Attention Camera is covered by the steering wheel.
- ▶ When wearing sunglasses with high protection against infrared light.

# Driving stability control systems

## Vehicle features and options

This chapter describes model-specific equipment, systems, and functions that are currently available, or may become available in the future, even if they are not present in the vehicle.

Additional information:

Vehicle equipment, refer to page 8.

## Antilock Braking System

### Principle

The Antilock Braking System prevents locking of the wheels during braking.

You remain able to steer your vehicle even during full braking, which increases active driving safety.

The Antilock Braking System activates automatically whenever drive-ready state is turned on.

### Malfunction



The Antilock Braking System warning light illuminates continuously on the instrument cluster if the system is not operational.



A Check Control message is displayed.

- ▶ The Antilock Braking System is not available.
- ▶ Steerability is limited during full braking.

Have the vehicle checked immediately by an authorized service center or another qualified service center or repair shop.

## Brake assistant

The brake assistant automatically applies maximum braking assistance when the brake pedal is depressed quickly. This reduces the braking distance to a minimum for full braking.

To make full use of braking assistance, do not reduce the pressure on the brake pedal during full braking.

## Compound brake

### General information

The M Compound brake is a high-performance brake system with perforated compound brake disks.

Due to the specific design, temporary function-related noise may occur after an extended minor load.

The function-related noises have no effect on the performance, operational reliability, and durability of the brake.

### Correct braking

To prevent function-related noises, depress the brakes hard a few times in regular intervals. Ensure that the traffic situation permits the braking.

With moisture on the brake disks, the brake system may be operated dry to prevent noise.

## Dynamic Stability Control

### Principle

Dynamic Stability Control helps keep your vehicle safely on the road in critical driving situations. Depending on the situation, the drive

power is reduced and wheels can be braked individually. This system can be activated or deactivated via My Modes.

Dynamic Stability Control will detect the following unstable driving conditions, for example:

- ▶ Skidding at the vehicle rear, which can lead to oversteering.
- ▶ Loss of adhesion of the front wheels, which can lead to understeering.

## Safety information

### WARNING

The system cannot serve as a substitute for the driver's personal judgment in assessing the traffic situation. Based on the limits of the system, it cannot independently react to all traffic situations. There is a risk of accident, injury, and property damage. Adjust driving style to traffic conditions. Watch the surrounding traffic situation closely, be ready to take over steering and braking at any time, and actively intervene where appropriate.

### WARNING

When driving with a roof load, e.g., roof bars, the vehicle's center of gravity is higher. This increases the risk of the vehicle tipping in critical driving situations. There is a risk of accident, injury, and property damage. Drive with roof load only with activated Dynamic Stability Control.

## Overview

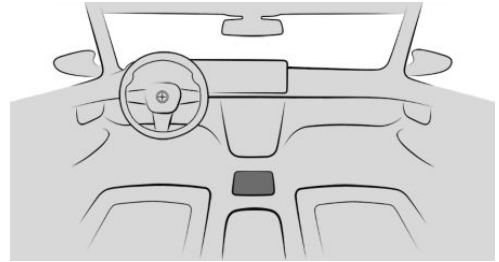



 The My Modes button located on the center console.

## Activating/deactivating Dynamic Stability Control

If Dynamic Stability Control is deactivated, driving stability is limited when accelerating and cornering.

To support driving stability, reactivate Dynamic Stability Control as soon as possible.

1.  Press the My Modes button on the center console.
2. "SPORT"
  - The last Dynamic Stability Control setting applied in this mode is activated.
3.  Tap the settings icon as necessary.
4. "Driving dynamics"
5. "DSC OFF"

Dynamic Stability Control is deactivated.

Dynamic Stability Control is automatically activated when changing to another drive mode.

## Displays in the instrument cluster



If the Dynamic Stability Control is deactivated, DSC OFF is displayed in the instrument cluster.



If the OFF indicator light for Dynamic Stability Control illuminates, the system is deactivated.



If the warning light for Dynamic Stability Control flashes, the system is regulating the drive and brake power. The vehicle is stabilized. Reduce the vehicle speed and adjust your driving style to the road conditions.



If the warning light for Dynamic Stability Control illuminates, the system has failed or is initializing. Driving stabilization is restricted or has failed.

If the warning light illuminates continuously, have the vehicle checked immediately by an authorized service center or another qualified service center or repair shop.

## Setting for increased driving dynamics

### Principle

For a more dynamic driving experience, you can increase the driving dynamics via My Modes.

Dynamic Stability Control, and thus driving stability, are limited while accelerating and cornering.

### Overview

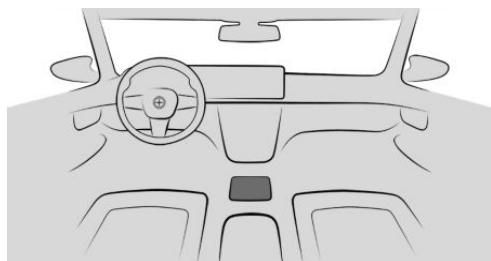



The My Modes button located on the center console.

### Functional requirements

To increase driving dynamics, you must select the following drive mode via My Modes: "SPORT".

### Activating/deactivating increased driving dynamics

-  To activate/deactivate increased driving dynamics, press the My Modes button on the center console.
- "SPORT"
  - The last Dynamic Stability Control setting applied in this mode is activated.
-  Select the settings icon.
- "Driving dynamics"
- "SPORT PLUS"

Increased driving dynamics is activated.

Dynamic Stability Control automatically reactivates when changing to another drive mode.

### Display in the instrument cluster



The Dynamic Stability Control indicator light on the instrument cluster illuminates when increased driving dynamics is activated.

### Automatic program change

Increased driving dynamics deactivates automatically in the following situations, for example:

- ▶ When Distance Control is activated.
- ▶ In case of a brake intervention by Forward Collision Mitigation. Deactivate Forward Collision Mitigation as necessary.
- ▶ If the suspension control system fails.
- ▶ The vehicle has a flat tire.

Additional information:

Forward Collision Mitigation with brake intervention, refer to page 169.

## Drive-off support

### Principle

Drive-off support provides the best possible traction when driving off in certain situations, e.g., on difficult surfaces like snow or sand.

This function ensures maximum drive power at low speeds with adapted driving stability.

### Activating/deactivating the drive-off support

To activate/deactivate drive-off support, go through the menu as follows: Apps menu / "Vehicle" / "Driving settings" / "Drivetrain and chassis" / "Activate drive-off support once".

Drive-off support remains on until it is deactivated or the driving mode is changed.

### Display in the instrument cluster



If drive-off support is activated, the drive-off support indicator light illuminates on the instrument cluster.

## BMW xDrive

BMW xDrive is the all-wheel-drive system of the vehicle. The interplay between BMW xDrive and other suspension control systems such as Dynamic Stability Control further optimizes traction and driving dynamics.

BMW xDrive variably distributes the drive forces to the front and rear axles as required by the driving situation and road conditions.

## Hill Descent Control

### Principle

Hill Descent Control is a downhill control feature for vehicles with all-wheel drive. This feature adjusts the vehicle speed on steep downhill gradients, e.g., when driving on unpaved roads.

When Hill Descent Control is on, the vehicle moves at the speed set by the driver, without the driver having to depress the brake pedal.

While Hill Descent Control is regulating the speed, it automatically distributes the brake power to the individual wheels. Driving stability and steerability are improved. If necessary, the Antilock Braking System prevents the wheels from locking.

Hill Descent Control can be enabled at speeds below approx. 25 mph/40 km/h.

Speeds can be set between approx. 2 mph/3 km/h and approx. 20 mph/30 km/h. While driving downhill, this system reduces the vehicle speed to the set value, as physically possible.

Hill Descent Control provides assistance when driving in selector lever positions D, N, and R.

### Vehicle features and options

This system may not be available in the owned vehicle, e.g. due to the selected optional equipment, the national-market version or the option for later enabling and software updates. This also applies to individual functions of the system.

For information on whether a function is currently available in the vehicle or when the function can be installed in the vehicle, contact an authorized service center or another qualified service center or repair shop.

Additional information:

Vehicle equipment, refer to page 8.

## Enabling/disabling Hill Descent Control

To activate/deactivate Hill Descent Control, go through the menu as follows: Apps menu / "Vehicle" / "Driving settings" / "Driver Assistance" / "Hill Descent Control".

Hill Descent Control is automatically disabled at speeds above approx. 25 mph/40 km/h.

While Hill Descent Control is regulating the vehicle speed, the following functions are deactivated:

- ▷ Forward Collision Mitigation.
- ▷ Active Park Distance Control emergency braking.

Additional information:

- ▷ Forward Collision Mitigation with brake intervention, refer to page [169](#).
- ▷ Active Park Distance Control, refer to page [253](#).

## Display in the instrument cluster

The set speed is displayed on the instrument cluster together with the indicator light for Hill Descent Control.



The display illuminates green when the system is on. Hill Descent Control decelerates the vehicle.



The indicator illuminates gray when the system is in standby.

## Display in the Head-up display

The status of Hill Descent Control can also be shown on the Head-up display.

## Increasing or decreasing vehicle speed

### Using the rocker button for Cruise Control



The desired speed for Hill Descent Control can be set using the rocker button on the left of the steering wheel.

- ▷ Press the rocker button up or down to gradually increase or decrease the set speed.
- ▷ Press the rocker button up/down and hold it until the desired speed is reached.

### Using the brake pedal

While Hill Descent Control is regulating the vehicle speed, the set speed can be decreased by depressing the brake pedal.

## Malfunction

If the Hill Descent Control malfunctions, a Check Control message is displayed on the instrument cluster.

## Servotronic

Servotronic is a speed-dependent steering support.

The system provides the steering force with more support at low speeds than at higher ones. This makes parking easier, for example, and makes the steering firmer when driving at faster speeds.

The steering force is adapted to the set drive mode to convey a firm, sporty feel or a comfortable steering response.

Additional information:

My Modes, refer to page [126](#).

# Driver assistance systems

## Vehicle features and options

This chapter describes model-specific equipment, systems, and functions that are currently available, or may become available in the future, even if they are not present in the vehicle.

Additional information:

Vehicle equipment, refer to page 8.

## Speed warning

### Principle

The speed warning can be used to set a speed limit. A warning will be issued when this speed limit is exceeded.

Another speed warning is given when the set speed limit is exceeded again after it has dropped by 3 mph/5 km/h.

### Settings

The Speed Limit Warning can be activated or deactivated. In addition, the speed limit for the warning can be configured.

1. To set the speed, go through the menu as follows: Apps menu / "All" / "Driving settings" / "Driver Assistance" / "Safety and warnings" / "Speed warning".
2. Select the desired setting.

## Speed Limit Info

### Speed Limit Info

#### Principle

Speed Limit Info uses a camera near the interior rearview mirror to detect road signs at

the edge of the road as well as overhead sign posts.

Speed Limit Info shows the currently valid speed limit in the instrument cluster and, if necessary, the Head-up display.

Speed Limit Info may also show speed limits that apply to routes that are not signposted if the navigation system has current map data.

### General information

Traffic signs with subplates are analyzed and compared with the vehicle's on-board data. The traffic sign will then be either displayed or ignored depending on the situation in the instrument cluster and the Head-up display.

For Speed Limit Info to function correctly, current map data for the country in which the vehicle is operated must be downloaded.

For information on the current map version and the driver assistance map, see "Driver assistance map" under "Navigation system".

Without map data, the system is subject to certain technical limitations. Traffic signs with speed limitations are detected and displayed only. Speed limits due to entering towns/cities, highway signs, etc., are not displayed. Speed limits with extra traffic signs are always displayed.

Additional information:

- ▶ Owner's Manual for Navigation, Entertainment, and Communication, refer to page 6.

### Safety information

#### WARNING

The system cannot serve as a substitute for the driver's personal judgment in assessing the traffic situation. Based on the limits of the system, it cannot independently react to all traffic situations. There is a risk of acci-





dent, injury, and property damage. Adjust driving style to traffic conditions. Watch the surrounding traffic situation closely, be ready to take over steering and braking at any time, and actively intervene where appropriate.

## Sensors

The system is controlled by a camera behind the windshield.

## Display

### Speed Limit Info

Icon	Description
	Current speed limit. Depending on the national-market version, it is possible to switch between the units of measurement.
	
	No data on current speed limit available.
	Speed Limit Info not available.

## Warning signals

Depending on the settings, an acoustic signal sounds if the detected speed limit is exceeded or the speed limit changes. The display also flashes if the detected speed limit is exceeded.

## Settings

Individual settings can be configured for Speed Limit Info, e.g., warnings issued if the speed is exceeded or the permissible maximum speed changes.

1. Go through the menu as follows: Apps menu / "Vehicle" / "Driving settings" /

"Driver Assistance" / "Driving" / "Speed Limit Assistant".

2. Select the desired setting.

## System limits

### System limits of the sensors

The sensors may not work properly, e.g., show something that is incorrect.

Additional information:

- ▶ Camera, refer to page 34.

### Functional limitations

Speed Limit Info may be restricted and provide incorrect information in the following situations:

- ▶ Traffic signs are completely or partially concealed by objects, stickers, or paint.
- ▶ Traffic signs do not adhere to applicable standards.
- ▶ In areas that are not included in the navigation system map data.
- ▶ If navigation system map data is invalid, outdated, or unavailable.
- ▶ When roads deviate from the navigation such as due to changes in road layout.
- ▶ When driving very close to the vehicle in front of you.
- ▶ When passing buses or trucks with traffic signs applied to them.
- ▶ In case of electronic traffic signs.
- ▶ When traffic signs that are valid for a parallel road are detected.
- ▶ In the presence of country-specific road signs or road layouts.

## Speed control systems

### Principle

The speed control systems provide assistance while driving, for example, by limiting your speed, maintaining your distance, or keeping your vehicle in its lane.

These systems are operated using the buttons on the steering wheel.

Speed control system information is displayed on the instrument cluster.

Depending on vehicle equipment, the speed control systems include the following individual systems:

- ▶ Cruise Control, refer to page 217.
- ▶ Distance Control, refer to page 219.
- ▶ Assisted Driving Mode, refer to page 225.
- ▶ Assisted Driving Mode Plus, refer to page 232.

Depending on the equipment and national-market version, the individual systems are enhanced with additional functions.





### Safety information

#### **WARNING**



The system cannot serve as a substitute for the driver's personal judgment in assessing the traffic situation. Based on the limits of the system, it cannot independently react to all traffic situations. There is a risk of accident, injury, and property damage. Adjust driving style to traffic conditions. Watch the surrounding traffic situation closely, be ready to take over steering and braking at any time, and actively intervene where appropriate.

## Overview

### Buttons on the steering wheel

Button	Function
	Turn last active speed control system on/off.
	Interrupt and continue speed control systems.
	Select the desired speed control system.
	Store current speed. Speed Limit Assistant: accept suggested speed manually.
	Set speed.

### Turning on/selecting speed control systems

1.  To activate the speed control system, press the on/off button on the left side of the steering wheel. The instrument cluster contains a toolbar with available speed control systems.
2.  To select a different speed control system while this system is active, repeatedly press the MODE button on the left of the steering wheel until the desired system is displayed on the toolbar on the instrument cluster.

The icon for the respective system is shown in white when the system can be activated.

The icon for the respective system is shown in green when the system is activated.

The icon for the respective system is grayed out if the system has failed or if the functional requirements have not been met.

**Icon Speed control system**

Cruise Control.



Distance Control.



Assisted Driving Mode: Cruise Control with Distance Control, Steering Assistance with lane keeping.



## Interrupting speed control systems automatically

Depending on the system, speed control systems are interrupted automatically, for instance in the following situations:

- ▶ When changing from selector lever position D to P, N, or R.
- ▶ While Dynamic Stability Control regulates driving stability.
- ▶ While Dynamic Stability Control is disabled.
- ▶ "SPORT PLUS": Upon activating the increased driving dynamics setting.
- ▶ When braking manually.

## Interrupting speed control systems manually

Speed control systems can be stopped manually.

- ▶  Press the on/off button on the left side of the steering wheel.
- ▶  Press the MODE button on the left side of the steering wheel.

The speed control system has been stopped.

## Continuing speed control systems



To resume the speed control system, press the on/off button on the left side of the steering wheel.

## Switching off speed control systems

Speed control systems can be switched off manually.



To turn off the speed control system, press and hold the on/off button on the left side of the steering wheel until the indicators go out.

Speed control systems switch off automatically when drive-ready state is switched off.

## Adjusting speed values

The speeds for the speed control systems can be adjusted on the steering wheel.



On the left side of the steering wheel, repeatedly press the rocker button up or down until the desired value is set.

- ▶ Each time the rocker button is pressed to the resistance point, the set speed increases or decreases by 1 mph/1 km/h.
- ▶ Each time the rocker button is pressed past the resistance point, the set speed changes by a maximum of 5 mph/10 km/h.

## Display in the instrument cluster

### Marking on speedometer



A marking for the speed set for the speed control system is shown on the speedometer.

- ▷ The marking illuminates green when the speed control system is active.
- ▷ The mark illuminates gray when the system is interrupted.
- ▷ No mark is shown when the system is turned off.

## Notifications

Messages are displayed for some functions in addition to the corresponding speed control system indicator lights.

1. To configure the notification scope, go through the menu as follows: Apps menu / "Vehicle" / "Driving settings" / "Driver Assistance" / "Driving" / "Notifications".
2. Select the desired setting.

## Cruise Control

### Principle

With the Cruise Control, the buttons on the left of the steering wheel can be used to adjust your set speed. The system maintains the set speed. This system automatically accelerates and brakes the vehicle as necessary.

Cruise Control information is displayed on the instrument cluster.

Cruise Control can be activated starting from a vehicle speed of 20 mph/30 km/h.

Depending on the vehicle setting, the Cruise Control settings can change under certain conditions. For instance, the acceleration can change depending on the driving mode.

### Safety information

#### **WARNING**

The system cannot serve as a substitute for the driver's personal judgment in assessing the traffic situation. Based on the limits of the system, it cannot independently react to

all traffic situations. There is a risk of accident, injury, and property damage. Adjust driving style to traffic conditions. Watch the surrounding traffic situation closely, be ready to take over steering and braking at any time, and actively intervene where appropriate.

#### **WARNING**

The use of the system can lead to an increased risk of accidents in the following situations, for instance:

- ▷ On winding roads.
- ▷ With high traffic volume.
- ▷ On slippery roads, in fog, snow, or wet conditions, or on a loose road surface.

There is a risk of accident, injury, and property damage. Only use the system if driving at constant speed is possible.

#### **WARNING**

The set speed can be incorrectly adjusted or called up by mistake. There is a risk of accident, injury, and property damage. Adjust the set speed to the traffic conditions. Watch surrounding traffic closely and actively intervene where appropriate.

## Overview

### Buttons on the steering wheel

#### Button Function



Turn last active speed control system on/off.

Interrupt and continue speed control systems.



Select the desired speed control system.

**Button Function**

 Store current speed.  
Speed Limit Assistant: accept suggested speed manually.



 Set speed.

## Turning on the Cruise Control

Cruise Control can be switched on as follows:

For vehicles equipped with Distance Control: change the Cruise Control mode to Cruise Control without Distance Control.

In vehicles without Distance Control: turn on the Cruise Control with the buttons on the steering wheel.

-  To switch on Cruise Control, press the on/off button on the left side of the steering wheel.
-  If necessary, repeatedly press the MODE button on the left side of the steering wheel until Cruise Control is selected.

Cruise Control is active. The current speed is maintained and stored as desired speed.

The indicator lights on the instrument cluster illuminate and the mark on the speedometer is set to the current speed.

The driving mode changes or Dynamic Stability Control activates when Cruise Control is switched on.

Additional information:

Distance Control, refer to page 219.

## Turning the speed control system off/interrupting

The speed control system can be turned off or canceled automatically or manually.

Additional information:

Speed control systems, refer to page 215.

## Adjusting the speed

### Store/maintain speed

The speed can be maintained and stored using the buttons on the steering wheel.

 Press the rocker button on the left side of the steering wheel up or down once while the system is stopped.

When Cruise Control is switched on, the current speed is maintained and saved as the desired speed.

The saved speed is shown on the speedometer.

If the Speed Limit Assistant is off, you can also save your current speed with the press of a button:

 Press the SET button on the left side of the steering wheel.

## Changing the speed

The speed can be changed with the buttons on the steering wheel.

 On the left side of the steering wheel, repeatedly press the rocker button up or down until the desired speed is set.

If active, the displayed speed is stored and the vehicle reaches the stored speed when the road is clear.

The maximum speed that can be set depends on the vehicle.

Press rocker button to resistance point and hold: The vehicle accelerates or decelerates without the accelerator pedal being pressed.

After the rocker button is released, the vehicle maintains the final speed achieved. Pressing the switch beyond the resistance point causes the vehicle to accelerate more rapidly.

## Continuing Cruise Control

### At the stored speed

#### WARNING

The set speed can be incorrectly adjusted or called up by mistake. There is a risk of accident, injury, and property damage. Adjust the set speed to the traffic conditions. Watch surrounding traffic closely and actively intervene where appropriate.

An interrupted Cruise Control can be continued by calling up the stored speed. The difference between the current speed and the stored speed should be as little as possible.



To resume Cruise Control while the system is stopped, press the on/off button on the left side of the steering wheel.

Cruise Control is continued with the stored values.

In the following cases, the stored speed value is deleted and cannot be called up again:

- ▶ When the system is switched off.
- ▶ When drive-ready state is switched off.

### At the current speed



To continue using the Cruise Control at the current speed, press the rocker button up or down on the left side of the steering wheel.

### Speed Limit Assistant: at the suggested speed



To apply the speed suggested by the Speed Limit Assistant to the Cruise Control, press the SET button on the left of the steering wheel.

## Displays in the instrument cluster

### Marking on speedometer

The marking on the speedometer indicates the status of the Cruise Control.



- ▶ The mark illuminates green when the system is active.
- ▶ The mark illuminates gray when the system is interrupted.
- ▶ No mark is shown when the system is turned off.

### Indicator light



The Cruise Control status is also displayed with the indicator light on the instrument cluster. The indicator light illuminates green when the system is activated.

## Displays in the Head-up display

Depending on vehicle equipment, some speed control system information can also be displayed on the Head-up display.

## System limits

Depending on the drive mode or drive power, the vehicle may exceed or drop below the set desired speed in some situations, e.g., when driving uphill or downhill.

Do not use Cruise Control when towing.

## Distance Control

### Principle

With the Distance Control, a distance to a vehicle driving ahead can be adjusted in addition to the Cruise Control.

The distance can be adjusted at several levels. For safety reasons, it depends on the respective speed.

The system maintains the set speed on clear roads. The vehicle accelerates or brakes automatically.

If a vehicle is driving ahead of you, the system adjusts the speed of the vehicle so that the set distance to the vehicle ahead is maintained. The speed is adjusted as far as the given situation allows.

If the preceding vehicle brakes to a stop then drives off again shortly afterward, Distance Control is capable of detecting this depending on vehicle equipment and ambient conditions.

Otherwise, drive off independently such as by stepping on the accelerator pedal or by pressing the button for the speed setting on the steering wheel.

Distance Control is operated using the buttons on the left of the steering wheel. The distance is set via iDrive.

Distance Control information is displayed on the instrument cluster.

## Safety information

### WARNING

The system cannot serve as a substitute for the driver's personal judgment in assessing the traffic situation. Based on the limits of the system, it cannot independently react to all traffic situations. There is a risk of accident, injury, and property damage. Adjust driving style to traffic conditions. Watch the surrounding traffic situation closely, be ready to take over steering and braking at any time, and actively intervene where appropriate.

### WARNING

An unsecured vehicle can begin to move and possibly roll away. There is a risk of accident, injury, and property damage. Before leaving the vehicle, secure the vehicle against rolling away.

In order to ensure that the vehicle is secured against rolling away, follow the following:

- ▷ Set the parking brake.
- ▷ Make sure that selector lever position P is engaged.
- ▷ On uphill grades or on downhill slopes, turn the front wheels in the direction of the curb.
- ▷ On uphill grades or on downhill slopes, also secure the vehicle, for instance with a wheel chock.

### WARNING

The set speed can be incorrectly adjusted or called up by mistake. There is a risk of accident, injury, and property damage. Adjust the set speed to the traffic conditions. Watch surrounding traffic closely and actively intervene where appropriate.

### WARNING





Risk of accident is greater when there is a high speed differential to other vehicles, for instance in the following situations:

- ▷ When approaching a slowly moving vehicle at speed.
- ▷ Vehicle suddenly swerving into own lane.
- ▷ When approaching stationary vehicles at speed.

There is a risk of injury and danger to life. Watch surrounding traffic closely and actively intervene where appropriate.

## Overview

### Buttons on the steering wheel

Button	Function
	Turn last active speed control system on/off. Interrupt and continue speed control systems.
	Select the desired speed control system.
	Store current speed. Speed Limit Assistant: accept suggested speed manually.
	Set speed.

### Sensors

Distance Control is controlled by the following sensors:

- ▷ Camera behind the windshield.
- ▷ Front radar sensor.
- ▷ Front ultrasonic sensors.
- ▷ Depending on vehicle equipment, via the front, side radar sensors.
- ▷ Driver Attention Camera, depending on vehicle equipment and national-market version.

Additional information:

- ▷ Sensors of the vehicle, refer to page 34.
- ▷ Driver Attention Camera, refer to page 206.

### Application range



Distance Control is best when used on well-maintained roads.

The maximum speed that can be set is limited and depends, for example, on the vehicle and the vehicle equipment.

The system can also be activated when stationary.

Do not use Cruise Control and Distance Control when towing.

### Turning on Cruise Control with Distance Control

1.  To switch on Cruise Control with Distance Control, press the on/off button on the left side of the steering wheel.
2.  If necessary, press the MODE button on the left side of the steering wheel repeatedly until Distance Control is selected.

Cruise Control with Distance Control is active. The current speed is maintained and stored as desired speed.

The selected distance to a vehicle driving ahead is maintained.

The indicator lights on the instrument cluster illuminate and the mark on the speedometer is set to the current speed.

The driving mode changes or Dynamic Stability Control activates when Distance Control is switched on.

### Adjusting the speed

The speed can be set with the buttons on the steering wheel.

Additional information:

Cruise Control, refer to page 217.

### Interrupting Cruise Control with Distance Control automatically

Cruise Control with Distance Control is interrupted automatically in the following situations, for example:

- ▷ When braking manually.
- ▷ When selector lever position D is disengaged.

- ▶ While Dynamic Stability Control is disabled.
- ▶ "SPORT PLUS": When the setting for enhanced driving dynamics is enabled.
- ▶ While Dynamic Stability Control regulates driving stability.
- ▶ When the driver's seat belt and driver's door are opened.
- ▶ If the system has not detected objects for an extended period, for instance on a road with very little traffic without curb or shoulder markings.
- ▶ If the detection range of the radar is impaired, for instance by contamination or heavy precipitation.
- ▶ After a longer stationary period when the vehicle has been braked to a stop by the system.

### Turning the speed control system off/interrupting

The speed control system can be turned off or canceled automatically or manually.

Additional information:

Speed control systems, refer to page 215.

### Continuing Cruise Control while driving

#### **WARNING**

The set speed can be incorrectly adjusted or called up by mistake. There is a risk of accident, injury, and property damage. Adjust the set speed to the traffic conditions. Watch surrounding traffic closely and actively intervene where appropriate.

An interrupted Cruise Control can be continued by calling up the stored speed. The difference between the current speed and the stored speed should be as little as possible.

Additional information:

Cruise Control, refer to page 217.

### Continuing Cruise Control while vehicle is stationary

If the Cruise Control is stopped, the driver may need to confirm their intention to drive off in certain situations.

The displays show the following:



The mark on the speedometer illuminates gray.



The Distance Control indicator light illuminates green.

Cruise Control can be continued as follows:

- ▶ Pressing the accelerator pedal.



- ▶ Press the rocker button on the left side of the steering wheel.



- ▶ Press the SET button on the left side of the steering wheel.

### Distance

#### Safety information

#### **WARNING**

The system cannot serve as a substitute for the driver's personal judgment. Due to the system limits, deceleration can be late. There is a risk of accident, injury, and property damage. Be aware of the surrounding traffic situation at all times. Adjust the distance to the traffic and weather conditions and maintain the prescribed safety distance, possibly by braking.

### Adjusting the distance

1. To adjust the distance, go through the menu as follows: Apps menu / "Vehicle" /

"Driving settings" / "Driver Assistance" / "Driving" / "Distance Control" / "Distance".

2. Select the desired setting.

## Automatic adaptation of the distance

Depending on vehicle equipment and national-market version, Distance Control can be configured to automatically adjust the distance to the preceding vehicle within the set distance. This system analyzes the traffic situation and ambient conditions.

If automatic adjustment is enabled, the distance is adjusted in the following situations, for example:

- ▶ With poor visibility, the distance is slightly increased.
- ▶ With heavy traffic, the distance is slightly decreased.

To have the distance adjusted automatically, go through the menu as follows: Apps menu / "Vehicle" / "Driving settings" / "Driver Assistance" / "Driving" / "Distance Control" / "Situational distance control".

## Changing between Cruise Control with/without Distance Control

### Safety information

#### **WARNING**

The system does not react to traffic driving ahead of you, but instead maintains the stored speed. There is a risk of accident, injury, and property damage. Adjust the set speed to the traffic conditions and brake as needed.

## Changing over the Cruise Control mode

To switch between Cruise Control with/without Distance Control, go through the menu as follows: Apps menu / "Vehicle" / "Driving

settings" / "Driver Assistance" / "Driving" / "Distance Control" / "Switch to Cruise Control".

The setting is reset when the vehicle is parked.

## Displays in the instrument cluster

### General information

Depending on vehicle equipment, the Distance Control displays on the instrument cluster may vary.



### Marking on speedometer

The marking on the speedometer indicates the status of the Cruise Control.



- ▶ The mark illuminates green when the system is active.
- ▶ The mark illuminates gray when the system is interrupted.
- ▶ No mark is shown when the system is turned off.

## Indicator lights and warning lights

Icon	Description
	Indicator light illuminates white: No Distance Control because accelerator pedal is being pressed.
	Indicator light illuminates green: Vehicle has been detected ahead of you. The vehicle icon goes out if no vehicle has been detected ahead of you. Indicator light flashes green: Preceding vehicle has driven off.

Icon	Description
	Indicator light flashes gray: Conditions are not adequate for the system to work. The system was deactivated but applies the brakes until you actively resume control by pressing on the brake pedal or accelerator pedal.
	Warning light flashes red and acoustic signal sounds: Brake and make an evasive maneuver, if necessary.

## Assisted View

Depending on vehicle equipment and national-market version, in Assisted View, Distance Control information is displayed on the central display area of the instrument cluster.

Additional information:

Assisted View, refer to page [147](#).

## Displays in the Head-up display

### Set speed

Depending on vehicle equipment, some speed control system information can also be displayed on the Head-up display.

## System limits

### System limits of the sensors

Distance Control is subject to the system limits of the sensors.

Additional information:

- ▷ Sensors of the vehicle, refer to page [34](#).
- ▷ Driver Attention Camera, refer to page [206](#).

## Detection range

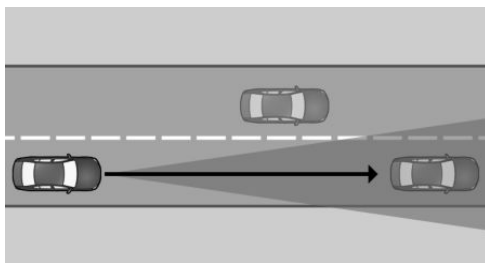

The vehicle sensors detect the traffic situation in their detection range.

The sensor detection capability and automatic braking power are limited.

For instance, two-wheeled vehicles may not be detected.

## Deceleration

Distance Control does not decelerate in the following situations:

- ▷ For pedestrians or similarly slow-moving road users.
- ▷ For cross traffic.
- ▷ For oncoming traffic.

## Merging vehicles

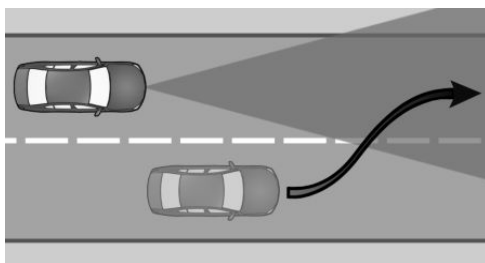

Distance Control may not be able automatically restore your chosen distance if a preceding vehicle suddenly cuts into your lane. It may not be possible to restore the selected distance in certain situations, including if you are driving significantly faster than vehicles driving ahead of you, for instance when rapidly

approaching a truck. When a vehicle has been detected ahead of you, the system requests that the driver intervene by braking and making an evasive maneuver, if needed.

## Cornering

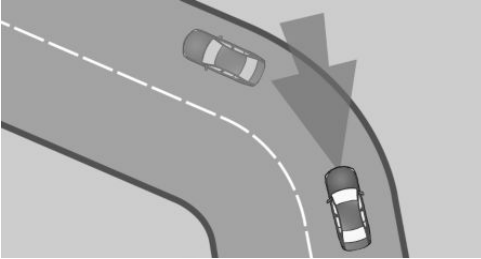

When Distance Control is on, if your set speed is too high for a bend, your vehicle will be slowed slightly in the bend. Because curves may not be anticipated in advance, drive into a curve at an appropriate speed.

Distance Control has a limited detection range. Situations can arise in tight curves where a vehicle driving ahead will not be detected or will be detected very late.

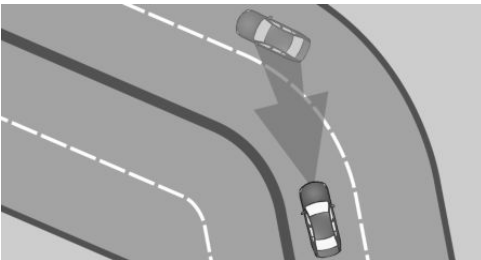

When you approach a curve the system may briefly report vehicles in the next lane due to the bend of the curve. If the system decelerates you may compensate for it by briefly accelerating. After releasing the accelerator pedal the system is reactivated and controls speed independently.

## Driving off

Your vehicle cannot drive off automatically using Distance Control in the following situations, for example:

- ▷ On steep uphill grades.
- ▷ In front of bumps in the road.

In these cases, step on the accelerator pedal.

## Weather

Under unfavorable weather or light conditions, Distance Control may be limited in the following ways:

- ▷ Poorer vehicle detection.
- ▷ Short-term interruptions for vehicles that are already recognized.

Drive attentively, and react to the current surrounding traffic situation. If necessary, intervene actively, for instance by braking, steering or making an evasive maneuver.

## Drive power

Depending on the drive mode or drive power, the vehicle may exceed or drop below the set desired speed in some situations, e.g., when driving uphill or downhill.

## Assisted Driving Mode

### Principle

Assisted Driving Mode enhances Distance Control with Steering Assistance and lane keeping. The system assists the driver in keeping the vehicle within the lane. This system assists the driver by moving the steering when necessary, e.g., when cornering.

Assisted Driving Mode is operated using the buttons on the steering wheel.

Depending on vehicle speed, Assisted Driving Mode orients itself using the lane boundaries or preceding vehicles.

Sensors in the steering wheel detect whether the steering wheel is being touched.

Depending on the vehicle equipment and national-market version, the Driver Attention Camera in the instrument cluster monitors the driver's attention.

System information is indicated on the instrument cluster displays and by the steering wheel LEDs.

If a lane boundary is crossed, the system issues a warning by vibrating the steering wheel. The steering wheel vibration intensity can be adjusted.

## Safety information

### WARNING

The system cannot serve as a substitute for the driver's personal judgment in assessing the traffic situation. Based on the limits of the system, it cannot independently react to all traffic situations. There is a risk of accident, injury, and property damage. Adjust driving style to traffic conditions. Watch the surrounding traffic situation closely, be ready to take over steering and braking at any time, and actively intervene where appropriate.





The Cruise Control and Distance Control alerts also apply.

Additional information:

- ▶ Cruise Control, refer to page 217.
- ▶ Distance Control, refer to page 219.

## Overview

### Buttons on the steering wheel

Button	Function
	Turn last active speed control system on/off.
	Interrupt and continue speed control systems.
	Select the desired speed control system.
	Store current speed. Speed Limit Assistant: accept suggested speed manually.
	Set speed.

## Sensors

Assisted Driving Mode is controlled by the following sensors:

- ▶ Camera behind the windshield.
- ▶ Front radar sensor.
- ▶ Depending on vehicle equipment, via the front, side radar sensors.
- ▶ Depending on vehicle equipment, via the rear, side radar sensors.
- ▶ The sensors in the steering wheel.
- ▶ Depending on the vehicle equipment and national-market version, the Driver Attention Camera in the instrument cluster.

Additional information:



- ▶ Sensors of the vehicle, refer to page 34.
- ▶ Driver Attention Camera, refer to page 206.

## Functional requirements

To use Assisted Driving Mode, the following functional requirements must be met:

- ▷ Depending on vehicle equipment, the speed must be below 130 mph/210 km/h or 110 mph/180 km/h.
- ▷ The lane is sufficiently wide.
- ▷ Hands are on the steering wheel rim.
- ▷ The bend radius is sufficiently large.
- ▷ The vehicle is driving in the center of the lane.
- ▷ The sensor system calibration process is complete.
- ▷ Distance Control is active.
- ▷ The seat belt on the driver's side is fastened.
- ▷ Forward Collision Mitigation is active.
- ▷ The Side Collision Protection must be active, depending on vehicle equipment.

## Switching on Assisted Driving Mode

1.  To switch Assisted Driving Mode on, press the on/off button on the left side of the steering wheel.
2.  If necessary, repeatedly press the MODE button on the left side of the steering wheel until Assisted Driving Mode is selected.

System activates automatically as soon as all function conditions are fulfilled.

The status of Assisted Driving Mode is displayed on the instrument cluster.

 The indicator light illuminates gray when the system is ready and not performing any steering movement.

 The indicator light illuminates green when the system is activated.

When the system is switched on, the Forward Collision Mitigation and, depending on the equipment, the Side Collision Protection are active.

## Stopping Assisted Driving Mode automatically

Assisted Driving Mode automatically interrupts steering support in the following situations, for example:



- ▷ Depending on vehicle equipment: at speeds greater than 130 mph/210 km/h or 110 mph/180 km/h.
- ▷ After releasing the steering wheel.
- ▷ With a strong steering intervention.
- ▷ When leaving own lane.
- ▷ When the turn signal is switched on or, depending on the vehicle equipment, when the driver turns the steering wheel while the turn signal is switched on.
- ▷ Lane is too narrow.
- ▷ If a lane boundary is not detected and there is no vehicle driving in front.
- ▷ The Cruise Control with Distance Control is interrupted.
- ▷ The seat belt on the driver's side is unfastened.



The indicator light illuminates gray when the system is ready and not performing any steering movement.

System activates automatically as soon as all function conditions are fulfilled.

## Displays in the instrument cluster

Icon	Description
	Indicator light illuminates gray: The system is ready.
	Indicator light illuminates green: The system is activated. The system supports the driver in keeping the vehicle within the lane.

**Icon Description**

 Warning light flashes yellow and steering wheel vibrates:  
A lane boundary has been crossed.

 Warning light illuminates yellow and acoustic signal sounds:  
System interruption is imminent.

 Warning light flashes red and acoustic signal sounds:  
The system is switched off or will be interrupted very soon.

 Warning light illuminates yellow:  
The driver's hands are not currently gripping the steering wheel. The system is still active.  
Grab the steering wheel with your hands.

 Warning light illuminates red, acoustic signal sounds:

 The driver's hands are not currently gripping the steering wheel or, depending on vehicle equipment and national-market version, the driver is not looking at the surrounding traffic. System interruption is imminent.

The system reduces the speed to a standstill if applicable.

It is possible that the system will not execute any supporting steering movements.

Immediately grasp the steering wheel with your hands and pay attention to the surrounding traffic.

Depending on the vehicle equipment and national-market version, a Check Control message is displayed if the Driver Attention Camera detects that the driver is inattentive.

Depending on vehicle equipment and national-market version, in Assisted View, Assisted

Driving Mode information is displayed on the central display area of the instrument cluster.

Additional information:

Assisted View, refer to page 147.

Displays on the steering wheel

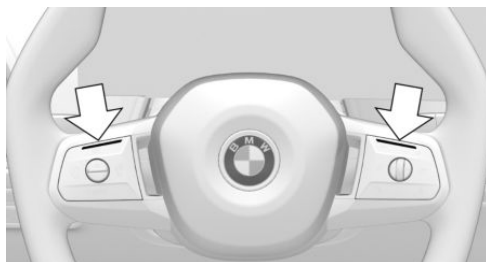

Similar to the displays for Assisted Driving Mode on the instrument cluster, the two LEDs above the keypads on the steering wheel illuminate.

1. To turn the steering wheel displays on/off, go through the menu as follows: Apps menu / "Vehicle" / "Driving settings" / "Driver Assistance" / "Feedback via steering wheel" / "Light elements".
2. Select the desired setting.

Displays in the Head-up display

Depending on vehicle equipment, Assisted Driving Mode information can also be shown on the Head-up display.

Setting the intensity of the steering wheel vibration

1. To adjust the steering wheel vibration intensity, go through the menu as follows: Apps menu / "Vehicle" / "Driving settings" / "Driver Assistance" / "Feedback via steering wheel" / "Vibration intensity".
2. Select the desired setting.

This setting is applied to all collision warning systems.

## System limits

### General information

Assisted Driving Mode cannot be activated or used sensibly in certain situations.

### Safety information

#### **WARNING**

Because of system limitations, this system may either not respond, or respond too late, incorrectly, or without cause. There is a risk of accident, injury, and property damage. Actively intervene as warranted. Refer to the information in this Owner's Manual regarding the scope of the system's operation and limitations.

The Cruise Control and Distance Control alerts also apply.

Additional information:

- ▶ Cruise Control, refer to page 217.
- ▶ Distance Control, refer to page 219.

### System limits of the sensors

Assisted Driving Mode is subject to the system limits of the sensors.

Additional information:

- ▶ Cameras, refer to page 34.
- ▶ Radar sensors, refer to page 35.
- ▶ Driver Attention Camera, refer to page 206.

### Hands on the steering wheel

The sensors cannot detect hand-steering wheel contact in the following situations:

- ▶ Driving with gloves.
- ▶ Protective covers on the steering wheel.

## Weather

With unfavorable weather or light conditions, Assisted Driving Mode may be limited as follows:

- ▶ Poorer recognition of vehicles and lane boundaries.
- ▶ Short-term interruptions in case of already detected vehicles and lane boundaries.

Drive attentively, and react to the current surrounding traffic situation. If necessary, intervene actively, for instance by braking, steering or making an evasive maneuver.

## Lane Change Assistant

### Principle

The Lane Change Assistant also performs slight steering interventions to assist the driver when changing lanes on multilane roads.

The Lane Change Assistant is switched on/off via iDrive and operated with the turn signal lever.

The following system functions are shown on the instrument cluster.

The Lane Change Assistant uses the Assisted Driving Mode sensors.

### Safety information

#### **WARNING**

The system cannot serve as a substitute for the driver's personal judgment in assessing the traffic situation. Based on the limits of the system, it cannot independently react to all traffic situations. There is a risk of accident, injury, and property damage. Adjust driving style to traffic conditions. Watch the surrounding traffic situation closely, be ready to take over steering and braking at any time, and actively intervene where appropriate.

Federal, state or local laws differ and the use of this function may be prohibited or limited. Before use, check federal, state and local laws.

The Assisted Driving Mode alerts also apply.

Additional information:

Assisted Driving Mode, refer to page [225](#).

## Functional requirements

To use the Lane Change Assistant, the following functional requirements must be met:

- ▶ The functional requirements for Assisted Driving Mode have been met.
- ▶ Driving on a highway-like road without pedestrians or cyclists. The road is also structurally separated from oncoming traffic, e.g., guard rails.
- ▶ A vehicle has been detected at a sufficient distance behind your own vehicle since beginning the drive.
- ▶ Crossable lane boundaries are detected.
- ▶ Vehicle speed is max. approx. 110 mph/180 km/h.
- ▶ The minimum speed is country-specific.

Additional information:

- ▶ Assisted Driving Mode, refer to page [225](#).

## Turning the Lane Change Assistant on/off

To turn the Lane Change Assistant on/off, go through the menu as follows: Apps menu / "Vehicle" / "Driving settings" / "Driver Assistance" / "Driving" / "Lane Change Assistant" / "Lane Change Assistant".

## Changing lanes

1. Ensure that the traffic situation permits changing lanes.
2. Start the lane change.



- ▶ To change lanes with Lane Change Assistant, press the turn signal lever in the desired direction to the resistance point.
- ▶ Depending on the vehicle equipment, the turn signal lever can also be pressed beyond the resistance point.

After a short time, Lane Change Assistant initiates a lane change.

After the lane change, the system helps keep the vehicle in the new lane.

The lane change can be canceled by steering movement into the opposite direction or by operating the turn signal in the opposite direction.

## Displays in the instrument cluster

Icon	Description
	Steering wheel icon and lane change arrow icon are green: The system performs a lane change in the arrow direction.
	Steering wheel icon is green and line for lane boundary on respective side is gray: The system detected the lane change request. Lane change not currently possible.

Depending on vehicle equipment and national-market version, in Assisted View, Lane Change Assistant information is displayed on the central display area of the instrument cluster.

Additional information:

Assisted View, refer to page [147](#).

## System limits

The Lane Change Assistant is subject to the system limits of Assisted Driving Mode.

Additional information:

Assisted Driving Mode, refer to page [225](#).

## Lane change with active guidance

### Principle

Lane change with active guidance assists the driver when lane changes are necessary to reach a destination. A corresponding prompt appears on the instrument cluster. In addition, a slight jerk can be felt on the steering wheel.

This function is switched on/off via iDrive.

When route guidance is active, the Lane Change function uses the Assisted Driving Mode sensors.

### Safety information

#### WARNING

The system cannot serve as a substitute for the driver's personal judgment in assessing the traffic situation. Based on the limits of the system, it cannot independently react to all traffic situations. There is a risk of accident, injury, and property damage. Adjust driving style to traffic conditions. Watch the surrounding traffic situation closely, be ready to take over steering and braking at any time, and actively intervene where appropriate.

The Cruise Control, Distance Control, and Assisted Driving alerts also apply.

Additional information:

- ▶ Cruise Control, refer to page [217](#).
- ▶ Distance Control, refer to page [219](#).
- ▶ Assisted Driving Mode, refer to page [225](#).

### Functional requirements

To change lanes when route guidance is on, the following functional requirements must be met:

- ▶ Cruise Control and Distance Control are activated.
- ▶ Driving on a highway or highway-like road.
- ▶ A situation-dependent minimum speed has been reached.
- ▶ The system detects a sufficiently large gap in traffic in the adjacent lane.
- ▶ A crossable lane boundary on the side of the desired lane change is detected.
- ▶ Destination guidance is active on the navigation system.  
The function is not available when using navigation software via Apple CarPlay or Android Auto.
- ▶ The function must be available in the country in which the vehicle is driven.
- ▶ The Driver Attention Camera in the instrument cluster detects that the driver is paying attention to the surrounding traffic.

### Switching lane change on/off with active destination guidance

To turn the Lane Change Assistant on/off while guidance is on, go through the menu as follows: Apps menu / "Vehicle" / "Driving settings" / "Driver Assistance" / "Driving" / "Lane Guiding with Navigation" / "Lane Guiding with Navigation".

### Switching the steering wheel jerk on/off

To enable/disable the steering wheel jerk for Lane Change Assistant, go through the menu as follows: Apps menu / "Vehicle" / "Driving settings" / "Driver Assistance" / "Driving" / "Lane Guiding with Navigation" / "Steering wheel impulse".

### Changing lanes

A corresponding prompt appears on the instrument cluster when changing lanes is nec-

essary to reach a destination. In addition, a slight jerk can be felt on the steering wheel.

To change lanes, follow the instructions on the instrument cluster.



1. The system detects a suitable gap in the flow of traffic in the adjacent lane. An icon with a green checkmark is displayed on the instrument cluster. The system prepares for the lane change.
2. When a suitable gap is detected, the speed is adapted so that the vehicle remains level with the opening.
3. A Check Control message indicates a lane change suggestion.
4. When the traffic permits changing lanes, the driver can steer the vehicle into an adjacent lane.

For vehicles equipped with Lane Change Assistant: once the Check Control message appears, the Lane Change Assistant can be started by, e.g., operating the turn signal.

5. If necessary, the system automatically starts additional lane changes.

## Display in the instrument cluster

Icon	Function
	Indicates a necessary lane change. The icon varies depending on the traffic situation.
	A green checkmark on the icon indicates that the function is active.
	A red cross on the icon indicates that the system cannot assist with the lane change.

Depending on vehicle equipment and national-market version, the traffic situation is displayed in Assisted View on the instrument cluster.

Additional information:

Assisted View, refer to page 147.

## System limits

The Lane Change Assistant with Active Guidance is subject to the system limits of the following systems:

- ▷ Cruise Control, refer to page 217.
- ▷ Distance Control, refer to page 219.
- ▷ Assisted Driving Mode, refer to page 225.
- ▷ Driver Attention Camera, refer to page 206.

## Assisted Driving Mode Plus

### Principle

Assisted Driving Mode Plus provides assistance with guiding the vehicle in traffic jams on select highways.

The system increases driving comfort in suitable driving situations.

Sensors in the steering wheel detect whether the steering wheel is being touched.

Assisted Driving Mode Plus is switched on/off via iDrive.

System information is indicated on the instrument cluster displays and by the steering wheel LEDs.

## Safety information

### WARNING

The system cannot serve as a substitute for the driver's personal judgment in assessing the traffic situation. Based on the limits of the system, it cannot independently react to all traffic situations. There is a risk of accident, injury, and property damage. Adjust driving style to traffic conditions. Watch the surrounding traffic situation closely, be ready to take over steering and braking at any time, and actively intervene where appropriate.

**⚠ WARNING**

This system is only intended for use on roads with structural separation from oncoming traffic, e.g., highways. Because of the system limits, the system can also remain active on roads without structural separations and may not react as expected. There is a risk of accident, injury, and property damage. Deactivate the system if it is enabled on roads without structural separations.

Federal, state or local laws differ and the use of this function may be prohibited or limited. Before use, check federal, state and local laws.

The Assisted Driving Mode alerts also apply.

Additional information:

Assisted Driving Mode, refer to page [225](#).

## Overview

### Sensors

Assisted Driving Mode Plus is controlled by the following sensors:

- ▷ Camera behind the windshield.
- ▷ Front radar sensor.
- ▷ Side radar sensors, front.
- ▷ Side radar sensors, rear.
- ▷ The sensors in the steering wheel.
- ▷ Driver Attention Camera.

Additional information:

Sensors of the vehicle, refer to page [34](#).

### Functional requirements

To use Assisted Driving Mode Plus, the following functional requirements must be met:

- ▷ Assisted Driving Mode Plus must be available in the country in which the vehicle is driven.
- ▷ The functional requirements for Assisted Driving Mode have been met.

Assisted Driving Mode is active and the LED displays on the steering wheel are switched on.

- ▷ Driving on a highway-like road without pedestrians or cyclists. The road is also structurally separated from oncoming traffic, e.g., guard rails.
- ▷ Lane boundaries are detected.
- ▷ The lane is sufficiently wide.
- ▷ The bend radius is sufficiently large.
- ▷ The navigation system must clearly identify the road and vehicle position.
- ▷ This function must be available on the road on which the vehicle is driving.
- ▷ Do not allow antennas on the roof to become covered, e.g., by roof loads or snow.
- ▷ The Driver Attention Camera in the instrument cluster detects that the driver is paying attention to the surrounding traffic.
- ▷ A vehicle has been detected ahead of you.
- ▷ Vehicle speed must be less than approx. 40 mph/60 km/h.

Additional information:

- ▷ Assisted Driving Mode, refer to page [225](#).

### Switching Assisted Driving Mode Plus on/off

To turn Assisted Driving Mode Plus on/off, go through the menu as follows: Apps menu / "Vehicle" / "Driving settings" / "Driver Assistance" / "Driving" / "Assisted Driving Plus" / "Assisted Driving Plus".

Assisted Driving Mode Plus is automatically offered when Assisted Driving Mode is active and all functional requirements for Assisted Driving Mode Plus have been met.

To activate this function, remove your hands from the steering wheel. Remain ready to steer and brake at all times.

Two green LED lights are illuminated on the steering wheel.





The indicator light in the instrument cluster is shown in green.

The system begins to assist the driver with vehicle control.

When the system is switched on, the following functions are enabled:

- ▶ Forward Collision Mitigation.
- ▶ Side Collision Protection.

## Displays in the instrument cluster

Icon	Description
	Indicator light green: system is active.
	Indicator light is white: system can be used.

## Displays on the steering wheel



The two LEDs above the keypads on the steering wheel illuminate depending on the situation.

- ▶ The LEDs on the steering wheel illuminate green when Assisted Driving Mode Plus is active.
- ▶ The LEDs on the steering wheel illuminate yellow when the system is interrupted. Grab the steering wheel with your hands.
- ▶ The LEDs on the steering wheel illuminate red when the system is deactivated.

Grab the steering wheel immediately with your hands.

Additional information:

Assisted Driving Mode, refer to page 225.

## Displays in the Head-up display

Depending on vehicle equipment, Assisted Driving Mode Plus information can also be shown on the Head-up display.

## System limits

Assisted Driving Mode Plus is subject to the system limits of the following systems:

- ▶ Assisted Driving Mode, refer to page 225.
- ▶ Driver Attention Camera, refer to page 206.
- ▶ Vehicle sensors, refer to page 34.

## Speed Limit Assistant

### Principle

Speed Limit Assistant supports driving at the speed limit. You can have speeds suggested by the Speed Limit Assistant adopted by your vehicle's speed control systems.

Speed Limit Assistant is switched on/off via iDrive and operated using the buttons on the steering wheel.

Suggested speeds can be adjusted by entering tolerances.

The following system functions are shown on the instrument cluster.

When the systems in the vehicle, e.g., Speed Limit Info, detect a change of the speed limit, this new speed value can be applied for the following systems:

- ▶ Cruise Control.
- ▶ Distance Control.
- ▶ Assisted Driving Mode.
- ▶ Assisted Driving Mode Plus.

The speed value is suggested as the new desired speed to be applied. To apply the speed value, the corresponding system must be activated.

Depending on the equipment, destination system and national-market version, the value can be applied automatically.

## Safety information

### WARNING



The system cannot serve as a substitute for the driver's personal judgment in assessing the traffic situation. Based on the limits of the system, it cannot independently react to all traffic situations. There is a risk of accident, injury, and property damage. Adjust driving style to traffic conditions. Watch the surrounding traffic situation closely, be ready to take over steering and braking at any time, and actively intervene where appropriate.

### WARNING

The set speed can be incorrectly adjusted or called up by mistake. There is a risk of accident, injury, and property damage. Adjust the set speed to the traffic conditions. Watch surrounding traffic closely and actively intervene where appropriate.

## Overview

### Buttons on the steering wheel

Button	Function
	Accept suggested speed manually.
	Set speed, refer to page 215.

## Turning Speed Limit Assistant on/off



- To configure the settings for Speed Limit Assistant, go through the menu as follows: Apps menu / "Vehicle" / "Driving settings" / "Driver Assistance" / "Driving" / "Speed Limit Assistant".
- Select the desired setting:
  - ▷ "Adjust automatically": depending on the equipment, detected speed limits are applied automatically.
  - ▷ "Adjust manually": detected speed limits can be applied manually.
  - ▷ "Show current limit": current speed limits are displayed without being applied in the instrument cluster.
  - ▷ "Off": depending on the national-market version, Speed Limit Info and Speed Limit Assistant will be turned off. If necessary, other anticipatory comfort functions will be turned off.

Additional information:

Speed Limit Info, refer to page 213.

## Displays in the instrument cluster

A message is displayed on the instrument cluster when Speed Limit Assistant and a speed control system are activated.

Icon	Function
	Detected change of a speed limit with immediate effect.
	Depending on the national-market version, it is possible to switch between the units of measurement.
	Indicator light illuminates green: the detected speed limit can be applied with the SET button. After it has been applied, a green checkmark is displayed.

## Automatic adoption

"Adjust automatically": Distance Control automatically adopts any detected speed limits when driving on roads with barriers separating traffic in opposing directions.

**SET** After automatic adoption, the SET button on the left side of the steering wheel can be pressed to switch back to the last value set for desired speed.

## Manual adoption

A detected speed limit can be applied manually to the active speed control system.

**SET** When the SET icon is displayed, press the SET button on the left side of the steering wheel.

## Speed adjustment

### General information

Speed Limit Assistant can be configured to adopt the speed limit 1:1 or with a tolerance.

A speed adaptation for all speed limits and an additional speed adaptation for speed limits up to 40 mph/60 km/h can be set up.

The additional speed adaptation for speed limits up to 40 mph/60 km/h can be activated or deactivated.

### Setting the speed adjustment

- To adjust the speed for Speed Limit Assistant, go through the menu as follows: Apps menu / "Vehicle" / "Driving settings" / "Driver Assistance" / "Driving" / "Speed Limit Assistant".
- Select the desired setting:

- ▶ "Adjust speed limits": Set a tolerance for a speed adjustment. This tolerance applies to all speed limits.
- ▶ "2nd adjustment up to ": Activate or deactivate additional speed adjustment.
- ▶ "Adjust speed limits": First activate additional speed adjustment, then set a tolerance for speed limits up to 40 mph/60 km/h.

## System limits

Speed Limit Assistant is based on the Speed Limit Info system.

Note the system limits for Speed Limit Info.

Speed limits cannot be applied automatically when using Cruise Control without Distance Control.

Additional information:

- ▶ System limits of Speed Limit Info, refer to page 214.
- ▶ System limits of the sensors, refer to page 34.

## Adapting the speed to the route

### Principle

The Cruise Control can be configured to automatically adjust the vehicle speed to the route when Distance Control is active.

For instance, the speed will be reduced in the following situations as necessary:

- ▶ Before making turns.
- ▶ Before a roundabout.
- ▶ Before a curve.
- ▶ In front of an exit ramp on highways or highway-like roads.

This function is operated via iDrive.

## Safety information

### WARNING

The system cannot serve as a substitute for the driver's personal judgment in assessing the traffic situation. Based on the limits of the system, it cannot independently react to all traffic situations. There is a risk of accident, injury, and property damage. Adjust driving style to traffic conditions. Watch the surrounding traffic situation closely, be ready to take over steering and braking at any time, and actively intervene where appropriate.

The Cruise Control, Distance Control, Assisted Driving Mode, and Speed Limit Assistant alerts also apply.

Additional information:

- ▶ Cruise Control, refer to page 217.
- ▶ Distance Control, refer to page 219.
- ▶ Assisted Driving Mode, refer to page 225.
- ▶ Speed Limit Assistant, refer to page 234.

## Functional requirements

To adapt the vehicle speed to the route, the following functional requirements must be met:

- ▶ Cruise Control and Distance Control are activated.
- ▶ Driving on a highway or highway-like road.
- ▶ Guidance is activated in the navigation system.

The use of navigation software via Apple CarPlay or Android Auto may lead to functional limitations, for instance deviations with navigation instructions.

- ▶ The function must be available in the country in which the vehicle is driven.

## Adapting speed automatically to route

To activate/deactivate automatic speed adjustment, go through the menu as follows: Apps menu / "Vehicle" / "Driving settings" / "Driver Assistance" / "Driving" / "Route control" / "Adjust speed automatically".

## Adjusting the cornering speed

The cornering speed can be adjusted depending on national-market version.

1. Go through the menu as follows: Apps menu / "Vehicle" / "Driving settings" / "Driver Assistance" / "Driving" / "Route control" / "Cornering speed".
2. Select the desired setting.

## Displays in the instrument cluster

Depending on vehicle equipment and national-market version, in Assisted View, Route-Ahead Assistant information is displayed on the central display range of the instrument cluster.

Additional information:

Assisted View, refer to page 147.

## System limits

Depending on national-market version or the country in which the vehicle is currently being driven, the Route-Ahead Assistant may not be available.

The system does not react or reacts to a limited extent to the route ahead in the following situations:

- ▶ If the vehicle location cannot be clearly determined by the navigation system.
- ▶ On wintry roads.

Additionally, the limits for Cruise Control, Distance Control, Assisted Driving, and Speed Limit Assistant systems apply.

Additional information:

- ▷ Cruise Control, refer to page [217](#).
- ▷ Distance Control, refer to page [219](#).
- ▷ Assisted Driving Mode, refer to page [225](#).
- ▷ Speed Limit Assistant, refer to page [234](#).

# Parking

## Vehicle features and options

This chapter describes model-specific equipment, systems, and functions that are currently available, or may become available in the future, even if they are not present in the vehicle.

Additional information:

Vehicle equipment, refer to page 8.

## Parking assistance systems

### Principle

With the Park Distance Control display and various camera views, the parking assistance systems help to park, maneuver, and reverse the vehicle. Parking assistance systems are operated using the Park Assist key or via the Parking menu.

When parking or reversing, the following individual systems provide active support with assistance functions and sensors:

- ▶ Park Distance Control, refer to page 250.
- ▶ Active Park Distance Control, refer to page 253.
- ▶ Drive-Off Monitoring, refer to page 254.
- ▶ Park Assist, refer to page 255.
- ▶ Maneuver Assistant, refer to page 261.
- ▶ Remote Control Parking, refer to page 264.
- ▶ Back-up Assistant, refer to page 265.

Various camera views and camera perspectives provide excellent visibility of the vehicle surroundings while parking and maneuvering. Depending on vehicle equipment, different camera views are available.

The following camera views can be used with the basic version:

- ▶ Rear View Camera, refer to page 244.
- ▶ Panorama view, rear, refer to page 247.

Depending on vehicle equipment, additional camera views can be used with parking view:

- ▶ Semi-automatic camera perspective, refer to page 245.
- ▶ Automatic camera perspective, refer to page 245.
- ▶ Side view, refer to page 246.
- ▶ 3D view, refer to page 246.
- ▶ Car wash view, refer to page 247.
- ▶ Panorama view, front, refer to page 247.
- ▶ Activating panorama view using activation points, refer to page 248.
- ▶ Door opening angle, refer to page 249.
- ▶ Remote 3D View, refer to page 249.

The camera-based individual systems are operated with the function bars on the control display. The camera views can be turned on and off by selecting the corresponding icon. Additional views with parking assistance lines or obstacle markings can be shown.

## Safety information

### WARNING

The system cannot serve as a substitute for the driver's personal judgment in assessing the traffic situation. Based on the limits of the system, it cannot independently react to all traffic situations. There is a risk of accident, injury, and property damage. Adjust driving style to traffic conditions. Watch the surrounding traffic situation closely, be ready to take over steering and braking at any time, and actively intervene where appropriate.

## Overview

### Button in the vehicle

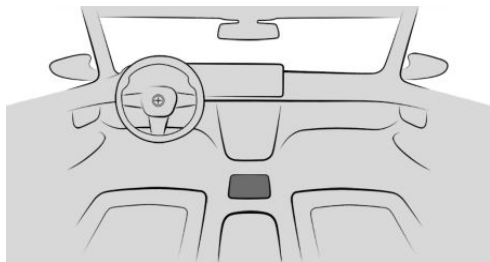

 The Park Assist key is located on the center console.

### Sensors

The parking assistance systems are controlled by the following sensors:

- ▶ Ultrasonic sensors in the front/rear bumpers.
- ▶ Ultrasonic sensors at the sides.
- ▶ Front camera.
- ▶ Exterior mirror cameras.
- ▶ Rear View Camera.

Additional information:

Sensors of the vehicle, refer to page 34.

### Calling up Park menu

Some parking assistance systems can be set individually in the Park menu.

1. To bring up the Parking menu, go through the menu as follows: Apps menu / "Vehicle" / "Driving settings" / "Driver Assistance" / "Parking".
2. Select the desired settings.

## Display

### Turning display on/off

#### General information

The parking assistance systems view switches off automatically when driving forwards or if a certain distance or speed is exceeded.

#### With reverse gear

When drive-ready state is on, the parking assistance systems display is automatically turned on when you engage selector lever position R.

#### With the Park Assist key



To turn on the parking assistance system display, press the Park Assist key on the center console.

#### Via iDrive

To turn on the parking assistance systems display, go through the menu as follows: Apps menu / "Vehicle" / "Parking".

### Display in the instrument cluster

The instrument cluster shows displays for some parking assistance systems such as Park Distance Control or Automatic Parking Assistant.

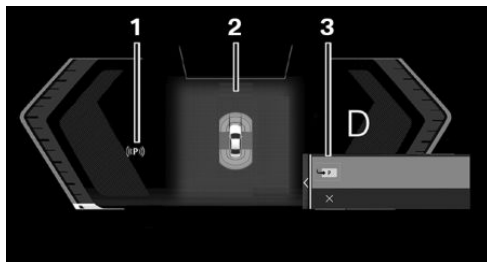

- 1 Status of parking assistance systems
- 2 Assisted View
- 3 Selection menu

## Display on the control display

### General information

The parking assistance system view on the control display varies depending on vehicle equipment and the parking assistance system activated.

### Assistance view

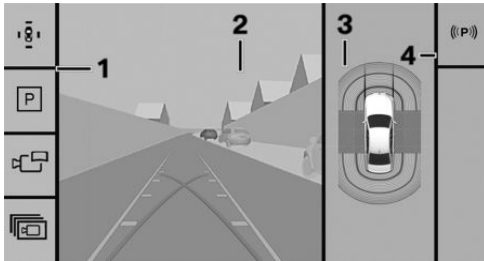

- 1 Toolbar, left
- 2 Camera image
- 3 Vehicle top view
- 4 Toolbar, right

### Parking view

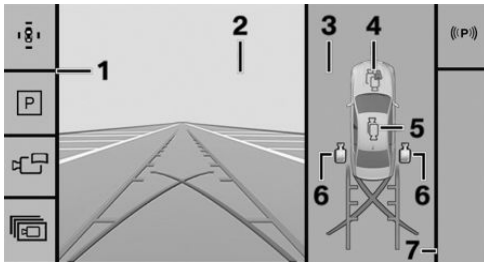

- 1 Toolbar, left
- 2 Camera image
- 3 Selection window
- 4 Automatic camera perspective
- 5 Semi-automatic camera perspective
- 6 Side view
- 7 Toolbar, right

### Camera image









Depending on the equipment, one or more cameras capture the area from different selectable perspectives.

Depending on the view, the vehicle's surroundings or a part of it is depicted.

Depending on the national-market version, either the automatic or the semi-automatic camera perspective is displayed.

### Toolbar, left

Different views and settings can be selected using the left toolbar, depending on vehicle equipment:

- ▷  "Parking view"
  - Depending on vehicle equipment, camera views or the Park Distance Control view are displayed.
- ▷  "Assist view"
  - A stylized top view of the vehicle is displayed.
- ▷  "Panorama view"
  - The cross traffic view is displayed.
- ▷  "More"
  - ▷  "3D view"
    - A three-dimensional view of the vehicle is displayed.
  - ▷  "Car wash view"
    - Your own lane can be displayed to make it easier to drive into a car wash.
  - ▷  "Camera cleaning"
    - When drive-ready state is on, the Rear View Camera cleaning can be activated as necessary.
  - ▷  "Settings"
    - Settings can be entered in the Park menu.

### Toolbar, right

The Parking Assistant functions are displayed in the right toolbar:

- ▷ Status of the parking assistance systems.
- ▷ Available parking methods of the Automatic Parking Assistant.
- ▷ Functions of the Back Up Assistant.
- ▷ Functions of the Maneuver Assistant.
- ▷ Additional information in case of malfunction.



## Status of parking assistance systems



The status of the parking assistance systems is indicated with icons as follows:

- ▷ On the right toolbar on the control display. Supplementary text is displayed in addition to the icon.
- ▷ In the status field on the instrument cluster.
- ▷ On the Head-up display, depending on vehicle equipment.

The following parking assistance systems are displayed:

- ▷ Automatic Parking Assistant.
- ▷ Maneuver Assistant.
- ▷ Back-up Assistant.

Icon	Meaning
	No search for parking assistance system offers. No other parking assistance systems available. Parking assistance systems have failed.
	Searching for parking assistance system offers is active.

Icon	Meaning
	White: an available maneuver is selected but is not being performed. Functional requirements have not been met or the function transfer is complete. Green: a parking assistance system is on. Functions are controlled depending on the system activated.
	The Maneuver Assistant records the maneuver to be saved.

## Additional displays

### General information

Additional views can be shown in the camera image for the parking assistance systems display, e.g., parking aid lines. This makes parking and maneuvering easier.

Several additional displays can be active at the same time.

### Turning additional displays on/off

1. To turn additional displays in the camera view on/off, go through the menu as follows: Apps menu / "Vehicle" / "Driving settings" / "Driver Assistance" / "Parking".
2. Select the desired setting.

## Parking aid lines

### Pathway lines

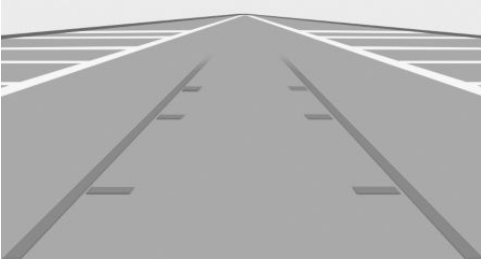

The pathway lines help to estimate the required space when parking and maneuvering on level roads.

Depending on the engaged gear position, the pathway lines are displayed in front of or behind the vehicle in the camera image on the control display.

The pathway lines are continuously adjusted to the steering movements depending on the steering-wheel angle.

### Turning circle lines

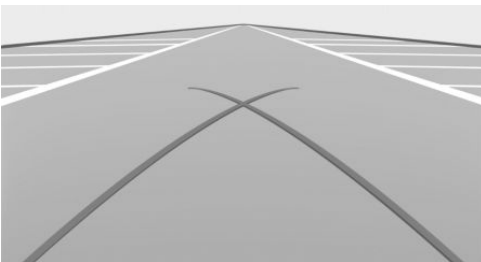

The turning circle lines show the path with the smallest possible turning circle on level roads in the camera image on the control display.

Only one turning circle line is displayed after the steering wheel is turned past a certain angle.

Turning circle lines can only be superimposed on the camera image together with pathway lines.

### Using parking aid lines

1. Position the vehicle so that the red turning circle line leads into the boundaries of the parking space.
2. Turn the steering wheel so that the green pathway line covers the corresponding turning circle line.

### Obstacle marking

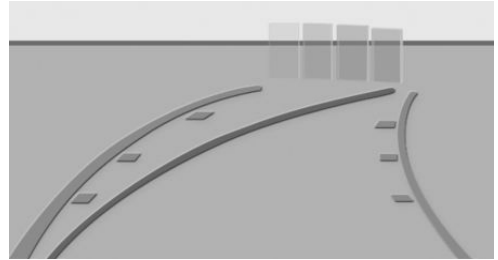

The sensors detect obstacles when parking.

The obstacles detected by the Park Distance Control are shown and marked in the camera image on the control display.

Colored gradients for the obstacle markings in green, yellow and red indicate the distances.

### Functional limitations

The parking assistance systems can only be used to a limited extent in the following situations:

- ▷ With a door open.
- ▷ With open cargo area.
- ▷ With exterior mirrors folded in.

Areas with gray hatching with an icon in the camera image identify areas that are currently not shown such as an open door.

## System limits

### Safety information

#### **WARNING**

Because of system limitations, this system may either not respond, or respond too late, incorrectly, or without cause. There is a risk of accident, injury, and property damage. Actively intervene as warranted. Refer to the information in this Owner's Manual regarding the scope of the system's operation and limitations.

### System limits of the sensors

Parking assistance systems may be restricted by the system limits of the sensors.

Additional information:

Sensors of the vehicle, refer to page 34.

### Field of view

Because of the camera angle, the areas under the vehicle cannot be viewed by the cameras.

### Detection of objects

The sensors may not detect very low obstacles as well as high, protruding objects, e.g., wall ledges.

Objects shown on the control display may be closer than they appear. Do not estimate the distance to the objects on the control display.

The camera's detection range can be limited by protruding cargo or a rear carrier.

### Malfunction

A camera failure is displayed on the control display.

The malfunctioning camera's detection range is shown by the shaded area on the control display.

## Rear View Camera

### Principle

The Rear View Camera helps when reverse parking and maneuvering. The area behind the vehicle is shown in the camera view on the control display. The Rear View Camera is switched on when reversing and can be operated via iDrive or the Park Assist key.

Additional information can be displayed on the camera view, e.g., parking assistance lines and obstacle markings.

In addition, note the information in Chapter "Parking assistance systems".

### Functional requirements

To use the Rear View Camera, the following functional requirements must be met:

- ▷ The cargo area is fully closed.
- ▷ The camera area is clean and clear.

### Turning the Rear View Camera on/off

#### Turning the camera view on automatically

The Rear View Camera is automatically turned on if selector lever position R is engaged while drive-ready state is on.

#### Turning the camera view off automatically

The Rear View Camera turns off automatically when driving forward or when a certain distance or speed is exceeded.

#### Turning the camera view on/off manually

1.  To manually switch on the Rear View Camera press the Park Assist button on the center console.

Parking assistance systems displays are shown on the control display.

## 2. Engage selector lever position R.

The Rear View Camera view is switched on.

 Depending on vehicle equipment: The icon for automatic camera perspective is automatically selected in the selection window.

To exit Rear View Camera view, select another camera view in the selection window or press the Park Assist key again.

## Deactivated Rear View Camera

When the Rear View Camera is deactivated, for instance when the cargo area is open, the camera image is displayed with gray shading.

## Semi-automatic camera perspective

### Principle

Depending on the parking direction and engaged selector lever position, the semi-automatic camera perspective shows a fixed camera perspective with the areas in front of or behind the vehicle.

You can turn the camera perspective on or off using the control display.

In addition, note the information in Chapter "Parking assistance systems".

### Turning the semi-automatic camera perspective on/off

-  To switch on the semi-automatic camera perspective, press the Park Assist key on the center console.

Parking assistance systems displays are shown on the control display.

-  Select the semi-automatic camera perspective icon in the selection window.

To exit the fixed camera view, select another camera view in the selection window.

## Automatic camera perspective

### Principle

The automatic camera perspective shows a steering-dependent view in the respective driving direction. This perspective adapts to the respective driving situation.

As soon as obstacles are detected, the view changes to a fixed display of the area in front of or behind the bumper, or switches to side Park Distance Control as necessary.

The side Park Distance Control is automatically displayed when the automatic camera perspective is turned on. The function shows obstacles located next to the vehicle.

You can turn the camera perspective on or off using the control display.

In addition, note the information in Chapter "Parking assistance systems".

### Turning the automatic camera perspective on/off

#### Turning the camera view on/off automatically

When the parking assistance systems' display is turned on, automatic camera perspective is selected automatically.



 The icon for automatic camera perspective is automatically selected in the selection window.

To exit the steering-dependent camera view, select another camera view in the selection window.

When reverse gear is engaged, the automatic camera perspective is, if necessary, exited and the system uses a semi-automatic camera perspective to the rear. If necessary, select the

automatic camera perspective when reverse gear is engaged. The automatic camera perspective will then be maintained for the current parking operation.

## Turning the camera view on/off manually

1.  To switch on automatic camera perspective, press the Park Assist button on the center console.  
Parking assistance systems displays are shown on the control display.
2.  The icon for automatic camera perspective is automatically selected in the selection window.

To exit the steering-dependent camera view, select another camera view in the selection window or press the Park Assist key again.

## Lateral Parking Aid display



To protect the sides of the vehicle, obstacle markings are displayed on the sides of the vehicle.

Colored obstacle markings warn the driver when obstacles have been detected.

If no obstacle markings are displayed, no obstacles have been detected.

## Limits of the side protection

The Lateral Parking Aid only displays stationary obstacles that were previously detected by the sensors while passing them.

The system does not detect whether an obstacle moves later on. For this reason, at standstill, the marks are not shown anymore in the display after a certain time. The area next to the vehicle must be newly captured.

## Side view

### Principle

Side view shows the vehicle's side surroundings, making it easier to position the vehicle at the curb or with other obstacles on the side.



The camera view looks from the rear to the front and, if there is a hazard, focuses automatically on potential obstacles.

Side view can be turned on or off using the control display.

In addition, note the information in Chapter "Parking assistance systems".

### Turning the side view on/off

The selection window lets you choose the side view for the left or right side of the vehicle.

1.  To switch on side view, press the Park Assist key on the center console.  
Parking assistance systems displays are shown on the control display.
2.  Select the camera icon for the desired vehicle side in the selection window.

To exit the side view, select another camera view in the selection window.

## 3D view

### Principle

With 3D view, a circle is displayed around the vehicle top view in the selection window.

Fixed perspectives can be selected directly on the circular path in the selection window, or by

swiping the vehicle in the middle of the camera image.

The current perspective is marked with a camera icon on the circular path.

3D view can be turned on or off using the control display.

In addition, note the information in Chapter "Parking assistance systems".

## Turning the 3D view on/off

-  To switch on 3D view, press the Park Assist key on the center console. Parking assistance systems displays are shown on the control display.
- Go through the menu as follows: "More" / "3D view".

To exit the 3D view, select another camera view on the left toolbar.

## Car wash view

### Principle

The car wash view assists when entering a car wash.

This function can be turned on or off on the control display.

In addition, note the information in Chapter "Parking assistance systems".

### Turning the car wash view on/off

-  To switch on the car wash view, press the Park Assist key on the center console. Parking assistance systems displays are shown on the control display.
- Go through the menu as follows: "More" / "Car wash view".

To exit the car wash view, select a different camera view in the left toolbar.

## Display

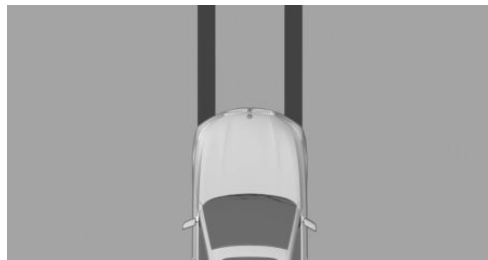

Your own lane is displayed for easier driving into a car wash.

This view can be used to position the vehicle correctly within the washing system guide rails.

In a car wash, the vehicle must be able to roll freely forward.

Additional information:

Rolling or pushing the vehicle, refer to page 121.

## Panorama View

### Principle

The panoramic view gives you an earlier view of crossing traffic at blind driveway exits and intersections.

Road users concealed by obstacles to the left and right of the vehicle can only be detected relatively late from the driver's seat. To provide greater visibility, the front camera and, depending on vehicle equipment, Rear View Camera cover the side of the vehicle.

The camera image shows different levels of distortion in some areas and is thus not suitable for distance estimations.

Depending on vehicle equipment, this function can be used when reversing or driving forward.

Panorama view can be turned on or off using the control display.

Depending on vehicle equipment, this function can be activated automatically by saving activation points.

In addition, note the information in Chapter "Parking assistance systems".

## Sensors

Panorama view is controlled by the following sensors:

- ▷ Rear View Camera.
- ▷ Depending on if vehicle is equipped with front camera.

## Turning the panoramic view on/off

1.  To turn on panorama view, press the Park Assist key on the center console. Parking assistance systems displays are shown on the control display.
2. Select the following menu: "Panorama view".

To exit panorama view, select another camera view on the left toolbar.

## Display



Yellow lines on the screen display identify the bumpers of your own vehicle.

When reverse gear is engaged, the Rear View Camera view is displayed. Depending on ve-

hicle equipment, the front camera view is displayed when forward gear is engaged.

## Automatic activation of panorama view

### Principle

Positions at which panorama view should switch on automatically can be saved as activation points.

Up to ten activation points can be saved and deleted.

The activation points can be used when driving forward and, depending on national-market version, when reversing.

In addition, note the information in Chapter "Panorama view".

### Functional requirements

To have panorama view activate automatically, the following functional requirements must be met:

- ▷ A GPS signal must be received.
- ▷ Depending on national-market version: You must activate a BMW ID or driver profile.
- ▷ The Rear View Camera and front camera must be installed.
- ▷ The direction of travel, the selector lever position, and the vehicle angle must match a stored activation point.

### Storing activation points

Desired activation points can be saved.

1. Drive your vehicle to the location where you want panorama view to switch on automatically, then stop.

2.  Press the Park Assist key on the center console.

Parking assistance systems displays are shown on the control display.

- Go through the menu as follows:  
"Panorama view" / "Activation point" / "Save activation point".

Activation points are saved with the following information, for example:

- ▷ With the city/town.
- ▷ With the city/town and the street.
- ▷ A default name.

## Using activation points

To enable/disable the use of activation points, go through the menu as follows: Apps menu / "Vehicle" / "Driving settings" / "Driver Assistance" / "Parking" / "GPS-based".

## Deleting activation points

Activation points can be deleted, individually or collectively.

-  Press the Park Assist key on the center console.  
Parking assistance systems displays are shown on the control display.
- Go through the menu as follows:  
"Panorama view" / "Manage points".  
A list of all saved activation points is displayed.
  - ▷ To delete an activation point, swipe over the desired activation point.
  - ▷ To delete all activation points, select the following function: "Delete all points".

## Door opening angle

### Principle

Depending on vehicle equipment, the door opening angle display is shown automatically when stationary.

This display helps estimate how far the doors can be opened when parking.

If obstacle marking is activated, the parking view indicates fixed obstacles that obstruct the opening angles of the doors.

In addition, note the information in Chapter "Parking assistance systems".

## Display

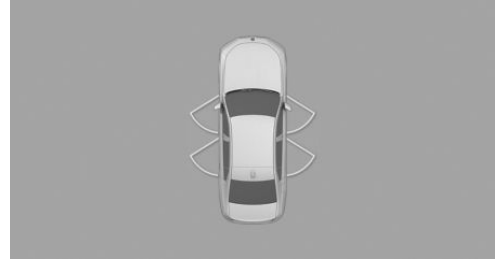

The maximum opening angle of the doors is displayed in selector lever position P.

## System limits

The door opening angle view does not warn you of approaching road users.

The vehicle's surroundings are distorted in the display for technical reasons.

Even if the door opening angle indicator on the control display does not overlap with any other objects, it is necessary to park carefully next to other objects.

Because of the perspective, higher, protruding objects may be closer than they appear on the control display.

## Remote 3D View

### Principle

The My BMW App and camera views in parking view such as automatic camera perspective enable you to display the vehicle's surroundings on a mobile device.

Remote 3D View shows a snapshot of the situation.

For reasons of data protection, Remote 3D View can only be used three times within two hours.

In addition, note the information in Chapter "Parking assistance systems".

## Sensors

Remote 3D View is controlled by the following sensors:

- ▷ Front camera.
- ▷ Exterior mirror cameras.
- ▷ Rear View Camera.

## Functional requirements

To use Remote 3D View, the following functional requirements must be met:

- ▷ Data transfer must be activated.
- ▷ The My BMW App must be installed on the mobile end device.
- ▷ In ConnectedDrive countries, you must activate a BMW ID with an existing ConnectedDrive account.

Additional information:

- ▷ Data protection, refer to page 60.
- ▷ BMW ID, refer to page 61.

## Activating/deactivating Remote 3D View

Remote 3D View can be activated or deactivated individually or together with other functions.

1. Go through the menu as follows: Apps menu / "All" / "Data privacy".
2. Select the desired setting.

After activation, Remote 3D View can be accessed using the My BMW App.

## System limits

Remote 3D View may not be fully operational or may not be available in the following situations:

- ▷ With a door or the cargo area open. Dark fields in the display indicate areas that are not recorded by the system.
- ▷ With manually folded-in exterior mirrors.
- ▷ When other camera functions are being performed in the vehicle.
- ▷ The vehicle moves faster than walking speed.
- ▷ In case of missing or weak Internet connection.

## Park Distance Control

### Principle

Park Distance Control assists with parking. Acoustic and visual warnings signal obstacles in front of or behind the vehicle.

Obstacles that are detected by the side ultrasonic sensors can also be reported.

The range of Park Distance Control, depending on obstacles and environmental conditions, is approx. 6 ft/2 m.

Park Distance Control turns on and off automatically in certain situations. You can enable or disable automatic activation on the control display.

In addition, note the information in Chapter "Parking assistance systems".

## Safety information

### WARNING

The system cannot serve as a substitute for the driver's personal judgment in assessing the traffic situation. Based on the limits of the system, it cannot independently react to all traffic situations. There is a risk of acci-

dent, injury, and property damage. Adjust driving style to traffic conditions. Watch the surrounding traffic situation closely, be ready to take over steering and braking at any time, and actively intervene where appropriate.

### **WARNING**

Due to high speeds when the Park Distance Control is activated, the warning can be delayed due to physical circumstances. There is a risk of injury and risk of property damage. Avoid approaching an object too fast. Avoid driving off quickly while Park Distance Control is not yet active.

## Sensors

Park Distance Control is controlled by the following sensors:

- ▶ Ultrasonic sensors in the front/rear bumpers.
- ▶ Ultrasonic sensors at the sides.

## Turning Park Distance Control on/off

### Turning on the system automatically

Park Distance Control switches on automatically in the following situations:

- ▶ When drive-ready state is switched on when selector lever position R is engaged.
- ▶ While approaching detected obstacles if the speed is lower than approx. 2.5 mph/4 km/h. The activation distance depends on the situation in question.

To activate/deactivate automatic activation when obstacles are detected, go through the menu as follows: Apps menu / "Vehicle" / "Driving settings" / "Driver Assistance" / "Parking" / "Automatic PDC activation".

### Turning off the system automatically

Park Distance Control switches off automatically when driving forward or if a certain distance or speed is exceeded.

### Turning the system on/off manually



To manually switch on Park Distance Control, press the Park Assist button on the center console.

When the LED illuminates, the system is on.

When the LED goes out, the system is off.

If the system is manually switched on when the reverse gear is engaged, the Rear View Camera image is displayed.

Depending on the national-market version, the system cannot be turned off manually when the reverse gear is engaged.

## Acoustic warning

### General information

An intermittent tone is given as acoustic warning for Park Distance Control to signal an approaching object. E.g., when an object is detected at the rear left of the vehicle, a sound is heard from the rear left speaker.

The shorter the distance to the object, the shorter the intervals of the intermittent tones.

An acoustic warning sounds in case of an impending collision at a distance to the object of approx. 27 in/70 cm.

For objects behind the vehicle, the acoustic warning is issued as early as a distance to the object of approx. 5 ft/1.50 m.

When the distance to a detected object is less than approx. 8 in/20 cm, a continuous tone is sounded.

When there are objects in front of and behind the vehicle at the same time, at a distance smaller than approx. 8 in/20 cm, an alternating continuous tone will sound between the front and rear speakers.

The intermittent tones and the continuous tone are turned off when selector lever position P is engaged.

Depending on national-market version, the intermittent tones are switched off after a short time when the vehicle is stationary.

If an object approaches when the vehicle is stationary, the acoustic signal is reactivated.

## Adjusting the volume

1. To adjust the volume of the acoustic warning, go through the menu as follows: Apps menu / "Vehicle" / "Driving settings" / "Driver Assistance" / "Parking" / "PDC signal volume".
2. Set the desired value.

## Depending on national-market version: Turn off acoustic warning

Depending on national-market version, the acoustic warning can be turned off while performing a parking maneuver.

 Press the acoustic warning icon in the status field at the top of the control display.

When the Park Distance Control is switched on again, the acoustic warning is automatically switched on again.

## Visual warning

### General information

The approach to an object is displayed on the control display and instrument cluster as soon as Park Distance Control is activated.

Objects that are farther away are already displayed before a signal sounds.

Depending on the view, pathway lines, turning circle lines and obstacle markings are shown for a better estimation of the space required.

Depending on vehicle equipment, the sensor detection range is shown by the shaded, ring-shaped area. Green, yellow, and red markings

indicate when obstacles are detected within the detection range.

If your vehicle is equipped with the Cross Traffic Warning, a warning is also shown on the display for vehicles approaching from the side at the rear and front.

To protect the sides of the vehicle, obstacle markings are displayed on the sides of the vehicle.

## Display

Depending on vehicle equipment, warnings may be displayed in front of, next to, and behind the vehicle.

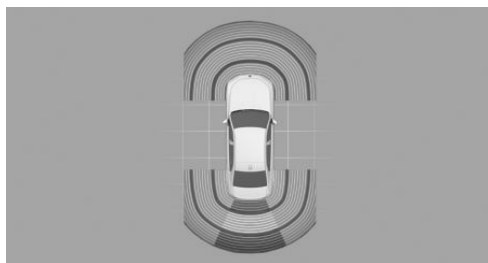

Example display of warnings behind the vehicle.

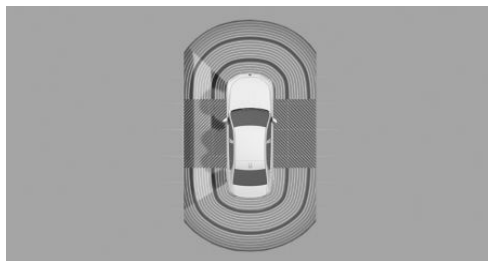

Example display of warnings next to the vehicle.

The gray shaded areas indicate the sensor detection range. No obstacles have been detected within detection range.

Colored markings in the shaded area indicate that obstacles have been detected within the detection range.

If the shaded area is not continuous, the area next to the vehicle has not been scanned yet.

## System limits

### General information

The function for protecting the vehicle sides only shows stationary obstacles that were previously detected by the sensors when passing by.

Park Distance Control does not detect when an obstacle moves later. When the vehicle is stationary, the gray shaded areas on the sides are hidden after a certain time. The area on the side of the vehicle must be newly captured.

Also follow the information on system limits in the "Parking assistance systems" chapter.

### Unwarranted warnings

Unwarranted warnings may be given if the system limits of Park Distance Control are reached.

To prevent unwarranted warnings, for instance in car washes, turn off automatic Park Distance Control activation on obstacle detection.

### Malfunction



If Park Distance Control malfunctions, the Attention icon appears on the control display.

Depending on vehicle equipment, the sensor detection range may not be shown on the control display.

A Check Control message is displayed.

Park Distance Control may not be operational. Have the vehicle checked by an authorized service center or another qualified service center or repair shop.

## Active Park Distance Control

### Principle

Active Park Distance Control is the brake function of Park Distance Control and initiates emergency braking in the event of an acute risk of collision.

The system can be used below walking speed when reversing or coasting backward.

Due to system limits, a collision cannot be prevented under all circumstances.

Pressing the accelerator pedal interrupts the brake intervention. Emergency braking is not performed.

Active Park Distance Control can be temporarily deactivated on the control display, where you can also change the settings for this system.

In addition, note the information in Chapter "Parking assistance systems".

### Safety information

#### **WARNING**

The system cannot serve as a substitute for the driver's personal judgment in assessing the traffic situation. Based on the limits of the system, it cannot independently react to all traffic situations. There is a risk of accident, injury, and property damage. Adjust driving style to traffic conditions. Watch the surrounding traffic situation closely, be ready to take over steering and braking at any time, and actively intervene where appropriate.

### Sensors

Active Park Distance Control is controlled by the following sensors:

- ▶ Ultrasonic sensors in rear bumpers.
- ▶ Ultrasonic sensors at the sides.
- ▶ Rear View Camera.

## Driving off after emergency braking

After emergency braking to a stop, further creeping toward an obstacle is possible. Proceed with caution. To move forward, lightly press the accelerator pedal and release as needed.

If the accelerator pedal is depressed longer, the vehicle drives off. Manual braking is possible at any time.

## Deactivating Active Park Distance Control temporarily

After emergency braking, Active Park Distance Control can be temporarily deactivated on the control display. A corresponding message is displayed.

Go through the menu as follows: "Configure" / "Deactivate temporarily".

No further emergency braking will be performed in this situation as you continue driving.

The function is automatically reactivated when Park Distance Control is switched on again.

## Settings

You can configure which areas of your vehicle to protect with the Park Distance Control system.

1. Go through the menu as follows: Apps menu / "Vehicle" / "Driving settings" / "Driver Assistance" / "Parking" / "Active PDC emergency braking".
2. Select the desired setting.

## Display



As soon as the system engages, an icon is displayed with a corresponding message.

## System limits

### General information

Follow the system limits in the "Parking assistance systems" chapter.

### Functional limitations

Active Park Distance Control cannot be used in the following situations, for example:

- ▶ While Hill Descent Control is regulating the vehicle speed, emergency braking is deactivated.

If applicable, turn off the system temporarily, if needed.

Additional information:

Hill Descent Control, refer to page [211](#).

## Drive-Off Monitoring

### Principle

In case of a risk of collision, the Drive-Off Monitoring reduces the drive power when driving off.

When obstacles are detected in close range in front of the vehicle, the acceleration will be reduced. If necessary, this permits timely manual braking.

When obstacles are detected behind the vehicle, the system will brake.

Drive-Off Monitoring can be activated/deactivated on the control display.

You can cancel reduced acceleration, e.g., by pressing the accelerator twice.

In addition, note the information in Chapter "Parking assistance systems".

## Safety information

### WARNING

The system cannot serve as a substitute for the driver's personal judgment in assessing the traffic situation. Based on the limits of the system, it cannot independently react to all traffic situations. There is a risk of accident, injury, and property damage. Adjust driving style to traffic conditions. Watch the surrounding traffic situation closely, be ready to take over steering and braking at any time, and actively intervene where appropriate.

## Sensors

Drive-Off Monitoring is controlled by the following sensors:

- ▶ Ultrasonic sensors in the front/rear bumpers.
- ▶ Ultrasonic sensors at the sides.

## Functional requirements

To use Drive-Off Monitoring, the following functional requirements must be met:

- ▶ Selector lever position D or R is engaged when the vehicle is stationary.
- ▶ Obstacles in the immediate vicinity are detected in front of or behind the vehicle.
- ▶ The accelerator pedal is heavily applied, nearly to the end point.
- ▶ The accelerator pedal is immediately applied after engaging the selector lever position and obstacle detection.

## Activating/deactivating Drive-Off Monitoring

To activate/deactivate Drive-Off Monitoring, go through the menu as follows: Apps menu / "Vehicle" / "Driving settings" / "Driver Assistance" / "Parking" / "Drive-Off Monitoring".

A Check Control message is displayed where applicable.

Depending on national-market version, this system turns on automatically for the next drive.

## Canceling reduced drive power

The reduction of the drive power is canceled in the following situations:

- ▶ The accelerator pedal is released.
- ▶ After the accelerator pedal has been depressed completely twice.
- ▶ A specific distance has been traveled.

If the reduction in drive power is canceled by covering a certain distance, the drive power is released gradually.

## Display



As soon as the system engages, an icon is displayed with a corresponding message.

## System limits

### General information

Follow the system limits in the "Parking assistance systems" chapter.

## Automatic Parking Assistant

### Principle

Automatic Parking Assistant provides support when parallel parking and parking transverse to the road.

In addition, the system makes it easier to park out of parallel and perpendicular parking spaces.

The ultrasonic sensors measure both sides of the vehicle when driving slowly forward. Suitable parking spaces are calculated based on the

objects detected, e.g., parking vehicles. The system status is displayed.

The system calculates the best possible parking line for driving in or out of parking spaces, and takes control of the vehicle while parking.

The operating principle and operation of Park Assist is divided into the following steps:

- ▷ Parking space search.
- ▷ Turning on.
- ▷ Parking.
- ▷ Driving out of parking spaces.

The parking manoeuvre while parking is performed automatically.

When driving out of parallel parking spaces, the vehicle maneuvers automatically until it reaches a position where it can be driven out of the parking space without further steering movements.

When driving out of perpendicular parking spaces, the vehicle is maneuvered out of the parking space to enable continued driving in the desired direction.

A parking maneuver can be interrupted and continued manually.

Settings can be customized as desired, e.g., to adjust how parking maneuvers are displayed or to set a sound for suitable parking spaces.

The Automatic Parking Assistant Professional increases the comfort and range of uses of the Automatic Parking Assistant. In addition to the parking methods of the Automatic Parking Assistant, parking in parking spaces that are marked with lines is possible.

The parking maneuver can also be performed using Remote Control Parking on a smart-phone.

In addition, note the information in Chapter "Parking assistance systems".

## Vehicle features and options

This system may not be available in the owned vehicle, e.g. due to the selected op-

tional equipment, the national-market version or the option for later enabling and software updates. This also applies to individual functions of the system.

For information on whether a function is currently available in the vehicle or when the function can be installed in the vehicle, contact an authorized service center or another qualified service center or repair shop.

Additional information:

Vehicle equipment, refer to page 8.

## Safety information

### **WARNING**

The system cannot serve as a substitute for the driver's personal judgment in assessing the traffic situation. Based on the limits of the system, it cannot independently react to all traffic situations. There is a risk of accident, injury, and property damage. Adjust driving style to traffic conditions. Watch the surrounding traffic situation closely, be ready to take over steering and braking at any time, and actively intervene where appropriate.

### **WARNING**

The system can steer the vehicle over or onto curbs. There is a risk of injury and risk of property damage. Watch surrounding traffic closely and actively intervene where appropriate.

## Parking methods

Park Assist supports the following functions:

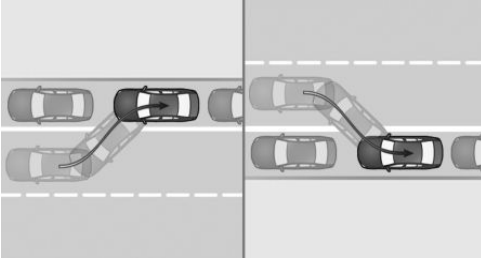

When parallel parking: Parking in reverse, parallel to the road.

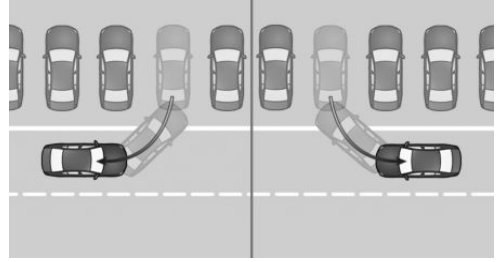

When driving out of perpendicular parking spaces.

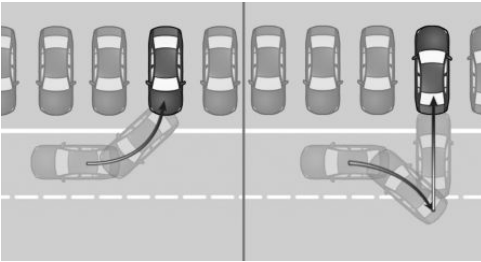

When perpendicular parking: Parking forward or in reverse, perpendicular to the road.

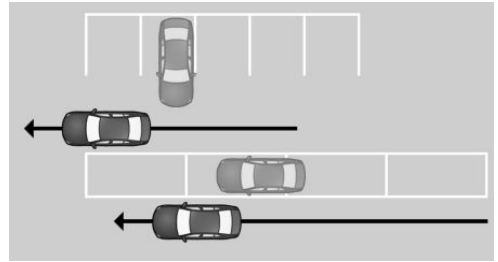

With Park Assist Professional: Parking in car parks with parking lines.

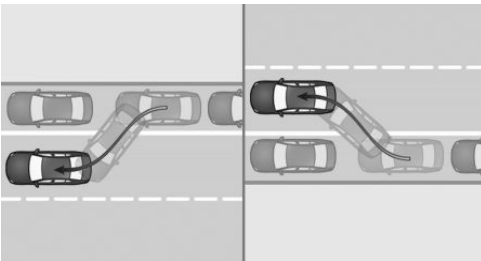

When driving out of parallel parking spaces.

## Sensors

The Automatic Parking Assistant is controlled by the following sensors:

- ▷ Ultrasonic sensors in the front/rear bumpers.
- ▷ Ultrasonic sensors at the sides.

The Automatic Parking Assistant Professional is additionally controlled by the following cameras:

- ▷ Front camera.
- ▷ Exterior mirror cameras.
- ▷ Rear View Camera.

## Functional requirements

### Measurement of parking spaces

To measure parking spaces, the following functional requirements must be met:

- ▶ Driving forward: up to approx. 22 mph/35 km/h.
- ▶ Maximum distance to row of parked vehicles: approx. 5 ft/1.5 m.

### Suitable parking space

To find suitable parking spaces, the following functional requirements must be met:

Longitudinal parking:

- ▶ Minimum length of detected object, e.g., parking vehicle: approx. 3 ft/1 m.
- ▶ Minimum length of gap between two objects: vehicle length plus approx. 2.6 ft/0.8 m.
- ▶ Minimum depth: approx. 5 ft/1.5 m.

Perpendicular parking:

- ▶ Minimum length of detected object, e.g., parking vehicle: approx. 3 ft/1 m.
- ▶ Minimum width of gap: vehicle width plus approx. 2.3 ft/0.7 m.
- ▶ The minimum depth corresponds to your vehicle's length.

The depth of perpendicular parking spaces must be estimated by the driver. Due to technical limitations, the system is only able to approximate the depth of perpendicular parking spaces.

Parking lines for Park Assist Professional:

- ▶ The parking space must be clearly marked with lines.
- ▶ The one-time calibration of the camera after vehicle delivery must be complete. To complete the calibration process, drive a short distance of a few miles in daylight.

### Parking operation

To pull into a parking space, the following functional requirements must be met:

- ▶ The doors and cargo area are closed.
- ▶ The driver's seat belt is fastened.

### Leaving parking spaces

To pull out of a parking space, the following functional requirements must be met:

- ▶ The vehicle was parked using the Automatic Parking Assistant, and an object has been detected in the area around the vehicle.
- ▶ The vehicle was manually parked in reverse, and objects have been detected in the immediate vicinity of the vehicle. The distance to a detected curb is at least 6 inches/15 cm.
- ▶ The parking space is at least 2.6 ft/0.8 m longer than the vehicle.

### Displays

#### General information





The current status of the Automatic Parking Assistant is shown as follows:

- ▶ On the right toolbar on the control display.
- ▶ In the status field on the instrument cluster.
- ▶ On the Head-up display, depending on vehicle equipment.

Different icons are shown on the control display for selecting the parking method.

The sequence of the displayed icons corresponds to the prioritized parking option.

The direction of the arrow changes for the icons for parking methods for driving out of a parking space.

Icon	Meaning
	Reverse lengthwise parking, right.
	Reverse lengthwise parking, left.
	Reverse perpendicular parking.
	Forward perpendicular parking.

## Turning parking operation display on/off

When the Automatic Parking Assistant is active, the parking operation is displayed in the camera image on the control display.

To turn the parking maneuver display on/off, go through the menu as follows: Apps menu / "Vehicle" / "Driving settings" / "Driver Assistance" / "Parking" / "Show assistance information".

## Turning the signal tone on/off

To turn the signal tone for suitable parking spaces on/off, go through the menu as follows: Apps menu / "Vehicle" / "Driving settings" / "Driver Assistance" / "Parking" / "Sound when available".

## Parking using the Automatic Parking Assistant

When parking with Park Assist, you must select a parking method depending on the available parking spaces.

1. For the parking space search when driving past parked vehicles at a speed of up to approx. 22 mph/35 km/h and a distance of max. 5 ft/1.5 m.

 The parking space search is activated and displayed on the instrument cluster.

2.  Press the Park Assist key on the center console or engage reverse gear.

The parking assistance systems view is displayed.

The status of the parking space search and possible parking spaces are displayed on the control display and in the instrument cluster.

3. On the control display: Select one of the parking methods offered. You can switch to another parking maneuver as necessary.

On the instrument cluster, select the suggested parking method using the thumbwheel on the steering wheel.

 The status symbol for the Automatic Parking Assistant illuminates green. The system takes control of the parking operation.

4. Follow the instructions on the control display or in the instrument cluster.

The speed can be reduced with the brake. Other interventions will cancel the system.

Depending on national-market version, an intermittent or continuous tone sounds for Park Distance Control.

At the end of the parking operation, selector lever position P is set.

The end of the parking operation is indicated on the control display and in the instrument cluster.

5. Adjust the parking position yourself, if needed.

## Driving out of a parking space using the Automatic Parking Assistant

1. Switch on drive-ready state to pull out of the parking space using Park Assist.

2.  When your vehicle is stationary, press the Park Assist key on the center console or engage reverse gear.

The parking assistance systems view is displayed.

3. On the control display: Select the desired parking method.

On the instrument cluster, select the suggested parking method using the thumbwheel on the steering wheel.

4. Follow the instructions on the control display or in the instrument cluster.

 The status symbol for the Automatic Parking Assistant illuminates green. The system takes control of the maneuver.

The speed can be reduced with the brake. Other interventions will cancel the system.

A message will be displayed at the end of the maneuver.

5. Make sure that the traffic situation permits driving out of parking space and driving off as usual.

The Automatic Parking Assistant is turned off automatically.

## Canceling Automatic Parking Assistant manually

The Automatic Parking Assistant can be canceled manually at any time, e.g.:

- ▷ Step lightly on the accelerator pedal twice in succession.
- ▷ Step lightly on the accelerator pedal and move the steering wheel slightly at the same time.
- ▷ Depress the brake pedal and operate the selector lever at the same time.

The Automatic Parking Assistant is canceled without engaging selector lever position P. Driving can continue immediately.

## Canceling Automatic Parking Assistant automatically

Park Assist is canceled automatically in situations such as the following:

- ▷ When the driver grasps the steering wheel or takes over steering.
- ▷ When operating the accelerator pedal or the selector lever.
- ▷ When setting the parking brake.
- ▷ When unfastening the driver's seat belt.
- ▷ With open cargo area.
- ▷ With open hood.
- ▷ With the doors open.
- ▷ During activation or intervention by driver assistance systems.

- ▷ When changing over to another function on the control display.
- ▷ When the view on the control display is overlaid with messages.
- ▷ On snow-covered or slippery road.
- ▷ On steep uphill or downhill grades.
- ▷ When there are obstacles that are hard to overcome such as curbs.
- ▷ When there are obstacles that suddenly appear.
- ▷ With insufficient distances, which are indicated by Park Distance Control.
- ▷ When a maximum number of parking attempts or the time taken for parking is exceeded.

When the system is automatically aborted, selector lever position P is engaged.

A Check Control message is displayed where applicable.

## Continuing the parking operation

If parking or leaving a parking space has been interrupted, the operation can be continued, if needed.

Restart the Automatic Parking Assistant and follow the instructions on the control display or instrument cluster.

## System limits

### General information

Follow the system limits in the "Parking assistance systems" chapter.

### No parking assistance

The Automatic Parking Assistant does not offer assistance in the following situations:

- ▷ In tight curves.
- ▷ For diagonal parking spaces.
- ▷ Automatic Parking Assistant: for parking spaces that are only marked with lines on

the ground. The system orients itself according to objects.

- ▶ For special parking spaces, e.g., metered parking spaces with automatic locking mechanisms, or mechanical parking systems.

### Functional limitations

Park Assist may be restricted in the following situations:

- ▶ On bumpy road surfaces such as gravel roads.
- ▶ On slippery ground.
- ▶ On steep uphill or downhill grades.
- ▶ With accumulations of leaves/snow in the parking space.
- ▶ In case of changes to an already-measured parking space.
- ▶ With ditches or edges, for instance an edge of a port.
- ▶ Parking spaces that are not suitable may be detected or suitable parking spaces may not be detected at all.

### Malfunction

A Check Control message is displayed.

The Automatic Parking Assistant may not be operational. Have the vehicle checked by an authorized service center or another qualified service center or repair shop.

## Maneuver Assistant

### Principle

The Maneuver Assistant provides support for recurring parking and maneuvering situations. This system can record and perform parking and maneuvering automatically.

A recurring maneuver is driven manually and thereby recorded.

When the vehicle reaches the activation area for the distance covered by the stored maneuver, the maneuver can be activated on the control display or in the instrument cluster.

After the activation, the system takes control of the vehicle and carries out the maneuver automatically.

The maneuver can also be performed using Remote Control Parking on a smartphone.

In addition, note the information in Chapter "Parking assistance systems".

### Vehicle features and options

This system may not be available in the owned vehicle, e.g. due to the selected optional equipment, the national-market version or the option for later enabling and software updates. This also applies to individual functions of the system.

For information on whether a function is currently available in the vehicle or when the function can be installed in the vehicle, contact an authorized service center or another qualified service center or repair shop.

Additional information:

Vehicle equipment, refer to page 8.

### Safety information

#### **WARNING**

The system cannot serve as a substitute for the driver's personal judgment in assessing the traffic situation. Based on the limits of the system, it cannot independently react to all traffic situations. There is a risk of accident, injury, and property damage. Adjust driving style to traffic conditions. Watch the surrounding traffic situation closely, be ready to take over steering and braking at any time, and actively intervene where appropriate.



 **WARNING**

The system can steer the vehicle over or onto curbs. There is a risk of injury and risk of property damage. Watch surrounding traffic closely and actively intervene where appropriate.

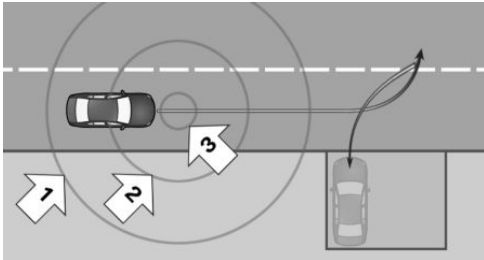
## Detection range



The detection range for a maneuver is divided into the following areas:

- ▶ Proximity range, arrow 1: the system will begin with the localization in the background within a range of approx. 26 ft/8 m around the distance covered of a stored maneuver.
- ▶  Close range, arrow 2: in a range of approx. 6 ft/2 m around the distance covered, a stored maneuver can be displayed on the control display.
- ▶  Activation range, arrow 3: the stored maneuver on the control display can be activated within a range of approx. 3.5 ft/1 m. After the activation, the system takes control of the vehicle and carries out the maneuver automatically.

## Sensors

The Maneuver Assistant is controlled by the following sensors:

- ▶ Ultrasonic sensors in the front/rear bumpers.
- ▶ Ultrasonic sensors at the sides.

- ▶ Front camera.
- ▶ Exterior mirror cameras.
- ▶ Rear View Camera.

## Functional requirements

To use the Maneuver Assistant, the one-off calibration process of the camera after vehicle delivery must be complete. To complete the calibration process, drive a short distance of a few miles in daylight.

## Recording maneuver

### General information

Up to ten maneuvers can be recorded at different locations.

Up to four overlapping maneuvers can be recorded.

Identical maneuvers under different ambient conditions can be recorded such as light conditions.

For each maneuver, a maximum distance covered of 656 ft/200 m is possible.

In total, a distance covered of approx. 1,969 ft/600 m distributed to the ten possible maneuvers can be recorded.

Maneuvers with a distance covered of less than 20 ft/6 m cannot be recorded.

## Recording maneuver

1. To record a maneuver, drive the vehicle to the desired starting point and stop.



2. Press the Park Assist key on the center console.

The parking assistance systems view is displayed.

3. Select the following function via iDrive:  "Record new path".
4. Drive the vehicle to the desired end position.



"Recording active": The maneuver is recorded.

When recording a route, do not drive faster than 9 mph/15 km/h.

While recording, the distance covered will be displayed.

When the maximum distance covered or the maximum speed is reached, a message will be displayed and a signal tone will sound.

- When the vehicle is stationary, select the following function via iDrive:  "Save recording".

The maneuver can be saved with an automatically generated name, or renamed or discarded.

- Select the desired action.

## Performing stored maneuver

- To perform the stored maneuver, drive the vehicle into the activation area and stop. The control display and instrument cluster indicate that a stored maneuver can be activated.
-  Press the icon to select the stored maneuver.

 The status symbol for the Maneuver Assistant illuminates green. After the activation, the system takes control of the vehicle and carries out the maneuver automatically. If applicable, follow the instructions on the control display or in the instrument cluster.

The speed can be reduced with the brake. Other interventions will cancel the system.

At the end of the parking operation, selector lever position P is set.

## Canceling the Maneuver Assistant manually

The vehicle can be controlled manually during an active maneuver by taking the following actions:

- ▷ Step lightly on the accelerator pedal twice in succession.
- ▷ Step lightly on the accelerator pedal and move the steering wheel slightly at the same time.
- ▷ Depress the brake pedal and operate the selector lever at the same time.

The Maneuver Assistant is canceled without engaging selector lever position P. Driving can continue immediately.

## Canceling the Maneuver Assistant automatically

The Maneuver Assistant is canceled automatically in situations such as the following:

- ▷ When the driver grasps the steering wheel or takes over steering.
- ▷ When operating the accelerator pedal or the selector lever.
- ▷ When the driver's seat belt is not fastened.
- ▷ With open cargo area.
- ▷ With open hood.
- ▷ With the doors open.
- ▷ During activation or intervention by driver assistance systems.
- ▷ When the system limits of the ultrasonic sensors and cameras are reached.
- ▷ When changing over to another function on the control display.
- ▷ When the view on the control display is overlaid with messages.
- ▷ In case of obstacles.
- ▷ On snow-covered or slippery road.
- ▷ When the lane is too narrow.
- ▷ On steep uphill or downhill grades.

In the event of an automatic cancellation of the system, the vehicle is decelerated to a complete stop and selector lever position P is engaged.

An interrupted maneuver can be continued, if needed. Restart the Maneuver Assistant and

follow the instructions on the control display or instrument cluster.

## Editing stored maneuvers

Maneuvers can be deleted or renamed via iDrive, individually or collectively.

1. Go through the menu as follows: Apps menu / "Vehicle" / "Driving settings" / "Driver Assistance" / "Parking" / "Recorded paths".
2. Select the maneuver to be edited.
3. Select the desired action.

## System limits

### General information

Follow the system limits in the "Parking assistance systems" chapter.

### Functional limitations

System limits can cause functional limitations such as in the following situations:

- ▶ With poor GPS reception.
- ▶ On steep uphill or downhill grades.
- ▶ In case of recorded maneuvers where the system minimum distance to objects cannot be maintained.
- ▶ Greatly deviating conditions when storing and driving the distance covered, for instance other tires or changed ambient conditions like light conditions or weather.
- ▶ Delayed display of overlapping stored maneuvers when driving into the activation area.
- ▶ In multi-story parking garages, for recordings at different parking levels, or for recordings that run over several parking levels.



If the calibration process for the camera is not completed after vehicle delivery, an icon appears on the display of

the parking assistance systems when reverse gear is engaged.

Tap the icon and follow the instructions on the control display.

## Remote Control Parking

### Principle

With Remote Control Parking, the vehicle can be driven remotely when parking and maneuvering using the Maneuver Assistant and Park Assist Professional.

When using this function, observe applicable national regulations.

The maneuver is performed independently, without you having to be inside the vehicle, using a smartphone and the My BMW App. Remote Control Parking makes getting in and out of the vehicle easier.

When parking in a suitable spot, e.g., a garage, the vehicle's parking position can be corrected by maneuvering manually with the My BMW App.

A maneuver that has already been started can be continued at any time with Remote Control Parking.

The smartphone is protected against unauthorized use.

The low-beam headlights are switched on for the duration of the maneuver.

A parking maneuver offered by Park Assist Professional is only available for Remote Control Parking for a short time after exiting the vehicle.

In addition, note the information in Chapter "Automatic Parking Assistant" and "Maneuver Assistant".

### Vehicle features and options

This system may not be available in the owned vehicle, e.g. due to the selected op-

tional equipment, the national-market version or the option for later enabling and software updates. This also applies to individual functions of the system.

For information on whether a function is currently available in the vehicle or when the function can be installed in the vehicle, contact an authorized service center or another qualified service center or repair shop.

Additional information:

Vehicle equipment, refer to page 8.

## Functional requirements

To use Remote Control Parking, the following functional requirements must be met:

- ▶ All occupants have left the vehicle.
- ▶ The doors and cargo area are closed.
- ▶ Make sure that no one is located within range of the maneuver.
- ▶ Make sure that no one is located in the narrow spaces between the vehicle and stationary objects, e.g., between the vehicle and a garage wall.
- ▶ To manually correct the vehicle position using the My BMW App, the minimum width of the parking space must be the vehicle width plus 1.9 ft/0.6 m.
- ▶ The smartphone is compatible with Remote Control Parking.
- ▶ The My BMW App must be installed on a compatible smartphone.
- ▶ The My BMW App must be linked to a ConnectedDrive account.
- ▶ Bluetooth must be enabled on the smartphone.
- ▶ The distance between vehicle and smartphone is no greater than approx. 19 ft/6 m.
- ▶ A valid digital key must be set up for the vehicle, then recognized without issue.

Additional information:

BMW Digital Key, refer to page 73.

## Parking with Remote Control Parking

1. To perform the parking maneuver with Remote Control Parking, engage selector lever position P.
2. Leave the vehicle and close the doors and cargo area.
3. Open Remote Control Parking in the My BMW app and maneuver forward or backward, or select the desired parking method.
4. Follow the instructions on the smartphone. Stop the vehicle manually if obstacles are present.

Depending on the option selected in the My BMW app, the vehicle is either parked at the end of the parking maneuver or you can take control of the vehicle again.

## System limits

Due to ambient conditions, e.g., impaired Bluetooth connection transmission due to external faults, Remote Control Parking may be interrupted.

If the power supply of the vehicle battery is not sufficiently ensured, e.g., due to excessive discharge, Remote Control Parking may not be available. Follow the instructions in the My BMW App.

It may not be easy to maneuver into a parking space. This function is offered on the My BMW app but cannot be used due to ambient conditions.

## Back Up Assistant

### Principle

The Back-up Assistant helps when reversing, e.g., when pulling out of tight or unclear parking or road situations.

The vehicle stores the driving movements of the last distance covered. This stored distance

can be driven in reverse with automated steering.

The Back-up Assistant takes control of steering. The driver must control the speed using the accelerator and brake pedals.

With Back-up Assistant: a maximum distance of 164 ft/50 m is saved.

With Reversing Assistant Professional: a maximum distance of 656 ft/200 m is saved.

In addition, note the information in Chapter "Parking assistance systems".

## Vehicle features and options

This system may not be available in the owned vehicle, e.g. due to the selected optional equipment, the national-market version or the option for later enabling and software updates. This also applies to individual functions of the system.

For information on whether a function is currently available in the vehicle or when the function can be installed in the vehicle, contact an authorized service center or another qualified service center or repair shop.

Additional information:

Vehicle equipment, refer to page 8.

## Safety information

### WARNING

The system cannot serve as a substitute for the driver's personal judgment in assessing the traffic situation. Based on the limits of the system, it cannot independently react to all traffic situations. There is a risk of accident, injury, and property damage. Adjust driving style to traffic conditions. Watch the surrounding traffic situation closely, be ready to take over steering and braking at any time, and actively intervene where appropriate.

### WARNING

The system can steer the vehicle over or onto curbs. There is a risk of injury and risk of property damage. Watch surrounding traffic closely and actively intervene where appropriate.

## Functional requirements

To use the Back Up Assistant, the following functional requirements must be met:

- ▷ Drive forward without interruption to store the distance covered.
- ▷ To store the distance covered, do not drive faster than 22 mph/35 km/h.
- ▷ Reversing Assistant Professional: sufficiently bright light conditions on the saved route.
- ▷ Reversing Assistant Professional: the cameras on the vehicle must be clean and clear.
- ▷ Reversing Assistant Professional: the one-off calibration of the camera after vehicle delivery must be complete. To complete the calibration process, drive a short distance of a few miles in daylight.

## Driving in reverse with automated steering

1. To reverse with automatic steering, switch on drive-ready state.



2. When your vehicle is stationary, press the Park Assist key on the center console or engage reverse gear.

The parking assistance systems view is displayed.

3. Bring up the following menu via iDrive:  "Start Back Up Assistant".

The length of the distance covered is displayed on the control display and in the instrument cluster.

If applicable, follow the instructions on the control display or in the instrument cluster.

4. Take your hands off the steering wheel and carefully drive in reverse with the accelerator pedal and the brake.

 The status symbol for the Back-up Assistant illuminates green. The system takes over the steering.

When driving in reverse, observe the vehicle's surroundings.

In case of obstacles, stop immediately and take over control of the vehicle. Follow the instructions for Park Distance Control.

5. Right before the end of the stored distance covered, a signal tone will sound and a message is displayed.

Stop no later than when normal road traffic is reached and take control of the vehicle such as by shifting to forward gear.

## Canceling the Back-up Assistant manually

The assisted reversing by the Back-up Assistant can be canceled manually:

- ▷ Bring up the following menu via iDrive:

 "Cancel".

- ▷  Press the Park Assist key on the center console.

## Canceling the Back Up Assistant automatically

The Back Up Assistant is canceled automatically in situations such as the following:

- ▷ When the driver grasps the steering wheel or takes over steering.
- ▷ When shifting from reverse gear to another selector lever position.
- ▷ During activation or intervention by driver assistance systems.

- ▷ When exiting the stored lane when reversing, for instance with maximum steering-wheel angle.
- ▷ When the view on the control display is overlaid with messages.
- ▷ In case of a slippery surface.
- ▷ When the vehicle is rolling such as on a slope.
- ▷ In case of changed ambient conditions.
- ▷ If the vehicle speed exceeds approx. 6 mph/10 km/h.
- ▷ Reversing Assistant Professional: if sensor functionality is limited beyond approx. 164 ft/50 m.

## System limits

### General information

Follow the system limits in the "Parking assistance systems" chapter.

### Speed threshold

The maximum speed when reversing is limited to approx. 6 mph/10 km/h.

A warning is issued at a speed of approx. 4 mph/7 km/h.

If the maximum speed is exceeded, the function is interrupted.

### Functional limitations

Different influences can lead to side deviations when driving the stored distance covered in reverse. The following influences, for example, can lead to deviation:

- ▷ Steering movements when the vehicle is stationary while storing the distance covered.
- ▷ The speed is not adapted to the distance covered.
- ▷ Certain road characteristics such as gradients, inclines or slippery road surface.



- ▶ Greatly deviating conditions when storing and driving the route, for instance other tires or changed ambient conditions like weather.
- ▶ Light conditions changed for Reversing Assistant Professional.

# Driving comfort

## Vehicle features and options

---

This chapter describes model-specific equipment, systems, and functions that are currently available, or may become available in the future, even if they are not present in the vehicle.

Additional information:

Vehicle equipment, refer to page 8.

## Adaptive M chassis

---

The Adaptive M Suspension is a variable, mechanically controlled sport suspension that reduces movement of the vehicle body while driving with a sporty style or on uneven roads.

Driving dynamics and driving comfort are increased through the adjustment of the chassis.

## BMW IconicSounds

---

Depending on vehicle equipment and national-market version, the vehicle drive sound can be adjusted using BMW IconicSounds.

1. To configure BMW IconicSounds, go through the menu as follows: Apps menu / "Vehicle" / "Driving settings" / "Drivetrain and chassis" / "IconicSounds".
2. Select the desired setting.

# Climate control

## Vehicle features and options

This chapter describes model-specific equipment, systems, and functions that are currently available, or may become available in the future, even if they are not present in the vehicle.

Additional information:







Vehicle equipment, refer to page 8.







## Climate control

### Overview

#### Functions in the Climate menu

Climate control functions, e.g., seat heating or air flow, can be adjusted from the Climate Control menu on the control display.



Icon	Function
	Turn the air conditioning system on/off.
	Automatic program.
	Manual program.
	Temperature in the vehicle interior.
	Air flow.
	Air conditioning.
	Maximum cooling.

Icon	Function
	Air recirculation mode.
	Automatic air recirculation.
	Fresh air.
	SYNC program.
	Seat heating.
	Steering wheel heating.
	Settings.

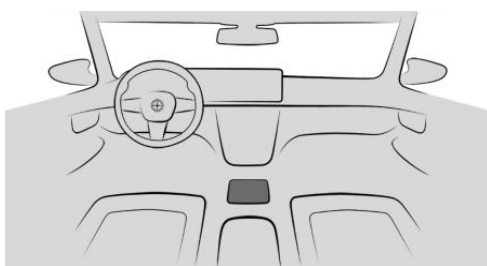
### Buttons, air conditioning system



The defrost function and rear window heating can be turned on/off using the center console.

Icon	Function
	Defrost function.
	Rear window defroster.

## Calling up climate control functions



To bring up the climate control functions individually, tap the Climate Control menu icon on the menu bar on the control display.

In fullscreen mode, the menu bar is hidden, e.g., for third-party apps. To show the menu bar again, swipe up from the bottom edge of the control display.

## Turning the air conditioning system on/off

The air conditioning system can be turned on/off via iDrive.

-  Select the Climate menu icon on the menu bar.

-  Tap the power button.

The entire air conditioning system is turned on/off with the last settings applied.

When the air conditioning system is on, individual climate control functions can be turned off.

Make sure that there is sufficient ventilation when staying in the vehicle for extended periods of time with the air conditioning system off, e.g., when sleeping.

## Settings

You can configure individual settings for climate control functions via iDrive, e.g.:

- ▷ Seat heating intensity.
- ▷ Pre-ventilation.

-  To configure the climate control functions individually, select the icon for the Climate Control menu on the menu bar.

-  Tap the settings button.
- Select the desired setting.

## Automatic program

### Principle

The automatic program ensures a comfortable climate, which can be adjusted by setting the desired temperature and configuring the settings.

Depending on vehicle equipment, the automatic program automatically adjusts the following climate control functions:

- ▷ Air flow.
- ▷ Air distribution.
- ▷ Temperature.
- ▷ Seat heating.
- ▷ Steering wheel heating.

The settings are affected by the following factors:

- ▷ Outside temperature.
- ▷ Interior temperature.
- ▷ Amount of direct sunlight.
- ▷ Seat occupancy.
- ▷ Desired temperature set.

### General information

The AUTO program takes seat occupancy into account to ensure that the energy consumption is low and the air conditioning is tailored to the occupants.

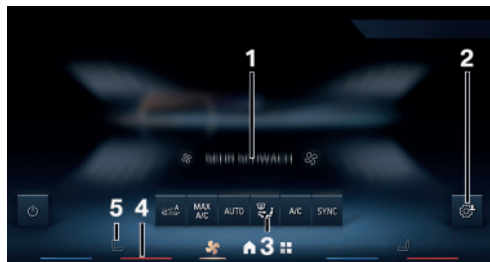

At the same time, a condensation sensor controls the automatic program in order to prevent window condensation to the extent possible.

## Overview



- 1 Air flow intensity
- 2 Settings
- 3 Climate control functions bar
- 4 Temperature
- 5 Seat heating  
Steering wheel heating



## Turning the automatic program on/off

1.  To turn the automatic program on/off, tap the Climate Control menu icon on the menu bar.
2.  Tap the automatic program button.

## Setting the intensity

When the automatic program is activated, the intensity of individual climate control func-

tions, e.g., seat heating, is adjusted individually.

1.  Select the Climate menu icon on the menu bar.
2.  Tap the settings button.
3. "Individual settings"
4. "Driver" or "Front passenger"
5. Select the desired setting.

Each level has a specific control range of the intensity.

Based on the stored data models, the intensities are dynamically adjusted while driving. It is not necessary to manually change the desired intensity to lower or higher levels while driving.

Custom settings for climate control functions are saved and applied automatically, e.g., after the vehicle is started.

## Temperature

### Principle

The air conditioning system cools or heats to the set temperature, keeping the temperature constant.

### Setting the temperature



Depending on vehicle equipment, the same temperature or a custom temperature can be

set using the menu bar for the driver's side and front passenger side:

- ▷ + Increase the temperature.
- ▷ — Reduce the temperature.

Do not rapidly switch between different temperature settings. Otherwise, the air conditioning system will not have enough time to adjust to the set temperature.

## Air flow

### Principle



The air flow generated by the blower can be adjusted as needed.

The air flow may be reduced to preserve the vehicle battery.

### Adjusting the air flow

1.  To adjust the air flow, tap the Climate Control menu icon on the menu bar.
2. Select the desired setting.

Automatic program:

- ▷  Tap the large air flow icon to increase the air flow.
- ▷  Tap the small air flow icon to reduce the air flow.

Manual mode:

- ▷ Tap the "Up" arrow to increase the air flow.
- ▷ Tap the "Down" arrow to decrease the air flow.

## Air distribution settings

### Principle

In manual mode, the air distribution can be adjusted as needed.

## Adjusting the air distribution

1.  To adjust the air distribution, tap the Climate Control menu icon on the menu bar.
2. Select the desired setting:
  - ▷ Aim the air flow into the footwell, arrow 1.
  - ▷ Aim the air flow toward the upper body area, arrow 2.
  - ▷ Aim the air flow at the windshield, arrow 3.

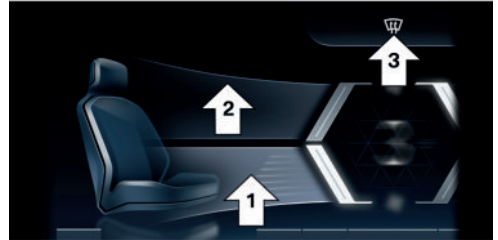

## Air conditioning



### Principle

With the climate control function, the air inside the vehicle is cooled and dehumidified, then warmed again depending on the temperature settings.

### Functional requirements

Standby or drive-ready state is on.

### Switching the cooling function on/off

1.  To turn the cooling on/off, tap the Climate Control menu icon on the menu bar.
2.  Tap the cooling button.

In recirculated-air mode, the air conditioning is automatically turned on to dry the air and avoid window condensation.

Depending on the weather, the windshield and the side windows may fog up briefly when drive-ready state is switched on.

Condensation may form in the vehicle air-conditioning system. Condensation leaking under the vehicle is due to technical reasons and does not constitute a malfunction.

## Maximum cooling

### Principle

Maximum cooling is used to cool the vehicle interior quickly and effectively.

The lowest temperature and the maximum air flow are set automatically.

### Functional requirements

To use Maximum Cooling, the following functional requirements must be met:

- ▷ Drive-ready state is switched on.
- ▷ The outside temperature is higher than 32°F / 0°C.

### Turning maximum cooling on/off

1. To turn maximum cooling on/off, tap the Climate Control menu icon on the menu bar.

2.  Tap the maximum cooling button.

Air flows out of the air vents to the upper body area. Open the vents.

## Air recirculation mode

### Principle

With air recirculation, if unpleasant odors or pollutants are detected in the outside air, the

outside air supply can be temporarily stopped. The interior air is recirculated.

With automatic air recirculation, outside air is fed in, or the interior air is recirculated, depending on the outside air quality.

When air recirculation is off, outside air is channeled into the interior.

The interior filter cleans the incoming fresh air or the circulated interior air in recirculation mode.

### General information

If there is window condensation, turn off the air recirculation.

### Turning air recirculation on/off

1.  To turn air recirculation on/off, tap the Climate Control menu icon on the menu bar.
2. The current operating mode is displayed on the climate control functions bar. Tap the button until the desired operating mode is set.

- ▷  Recirculating air.

- ▷  Fresh air.

- ▷  Automatic air recirculation.

Depending on vehicle equipment, the air recirculation turns off automatically after some time based on the ambient conditions in order to prevent condensation.

## SYNC program

### Principle



If the SYNC program is activated, the temperature settings for the driver's side are transferred to the passenger's side.

For improved comfort, when the SYNC program is deactivated, the following settings are adjusted automatically in the automatic program depending on seat occupancy:

If the front passenger seat is unoccupied, the settings for the driver's side are applied to the front passenger side.

When the seat is occupied again, the most recent settings are reapplied.

### Turning the SYNC program on/off

-  To turn the SYNC program on/off for the rear air conditioning system, tap the Climate Control menu icon on the menu bar.
-  Tap the SYNC program button.

If the temperature settings for the front passenger's side are changed, the SYNC program turns off automatically.

## Defrost function

### Principle

With the defrost function, ice and condensation are quickly removed from the windshield and the front side windows.

The air flow and air temperature are automatically optimized for the removal of ice and condensation.

The air distribution is directed toward the windshield and front side windows.

If there is window condensation, turn on the automatic program to take advantage of the condensation sensor.

A clean windshield is less prone to fogging up. Clean the inner side of the windshield regularly.

### Turning the defrost function on/off



To turn the defrost function on/off, push the defrost button on the center console.

The LED of the button is illuminated when the system is switched on.

Make sure that air is able to flow to the windshield and front side windows.

## Rear window defroster

### Principle

The rear window heating quickly removes ice and condensation from the rear window, depending on the outside temperature.

The rear window heating can either be set to turn off automatically after some time or used in continuous operation.

### Functional requirements

To use the rear window heating, the following functional requirements must be met:

- ▷ Drive-ready state is switched on.
- ▷ The rear window heating can only be activated and kept on at an outside temperature of below approx. 41°F / 5°C.

### Turning the rear window defroster on/off



To turn the rear window heating on/off, briefly push the rear window heating button on the center console.

The LED illuminates when the rear window heating is turned on.

To keep the rear window heating on, press and hold the button for at least 3 seconds.

## Seat heating

### Principle

When the seat heating is used, seats are heated depending on the outside temperature and the interior temperature.

### General information

If the trip is continued within approx. 15 minutes after an intermediate stop, the functions are turned on automatically with the temperature that was last set.

### Adjusting seat heating

#### Automatic program

When the automatic program is activated, the intensity of seat heating can be adjusted. As you drive, the heater output is automatically adjusted according to your set intensity.

#### Adjusting seat heating manually

The heater output level can be adjusted manually:



1. Select the icon for seat climate control on the menu bar, arrow 1.
2. Tap the seat heating button repeatedly until the desired level is selected, arrow 2.

To turn off the seat heating, press and hold the seat heating button for approx. three seconds.

If a consumption-optimized drive mode is selected, the heater output is reduced.

## Steering wheel heating

### Principle

When the steering wheel heating is used, the steering wheel is heated depending on the outside temperature and the interior temperature.

### Adjusting steering wheel heating

#### Automatic program

When the automatic program is activated, the intensity of steering wheel heating can be adjusted. As you drive, the heater output is automatically adjusted according to your set intensity.

#### Adjusting steering wheel heating manually

The heater output level can be adjusted manually:



1. Select the icon for seat climate control on the menu bar, arrow 1.
2.  Tap the steering wheel heating button repeatedly until the desired level is selected, arrow 2.

If a consumption-optimized drive mode is selected, the heater output is reduced.

## Ventilation

### Principle

The ventilation system provides custom adjustment ranges for direct/indirect ventilation in order to optimize the flow of air within the vehicle.

The air flow heats or cools noticeably, depending on the set desired temperature.

### Front ventilation

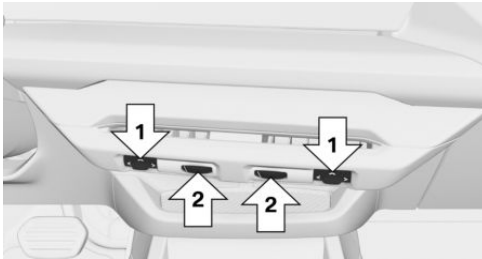

- ▷ Change the air flow direction, arrows 1.
- ▷ Thumbwheel for the variable adjustment of the air flow on the vents, arrows 2.

### Ventilation in the rear

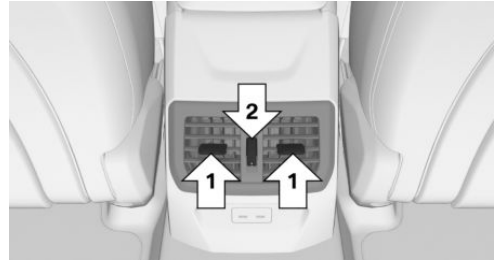

- ▷ The lever can be used to change the air flow direction, arrow 1.
- ▷ The air flow at the air vent can be continuously adjusted using the thumbwheel, arrow 2.

### Setting the ventilation

Depending on the desired ventilation, align the air flow directly or indirectly toward the passengers.

Open the air vents and position them to ensure effective air conditioning.

## Air quality

### General information

The following components improve the air quality inside the vehicle:

- ▷ Emissions-tested vehicle interior.
- ▷ Interior filter.
- ▷ Air conditioning system to control the temperature, air flow, and air recirculation.
- ▷ Pre-ventilation.

### Interior filter

The interior filter cleans the incoming fresh air or the circulated interior air in recirculation mode.

Depending on the equipment:

- ▷ Dust and pollen is filtered out from the in-flowing air.
- ▷ Nano-particle emissions are reduced.
- ▷ Gaseous pollutants are filtered.
- ▷ Microbial particles, viruses and allergens are filtered.

The manufacturer of the vehicle recommends having the interior filter changed during vehicle maintenance.

## Pre-ventilation

### Principle

Pre-ventilation is used to cool or heat the vehicle interior before beginning a drive. Depending on the set temperature and ambient temperature, the vehicle interior is ventilated or, depending on model variant, heated using the residual engine heat.

The system can be switched on and off directly or via a preset departure time.

The activation time is determined based on the outside temperature. The system promptly switches on before the selected departure time.

The system switches off automatically after a certain period of time. The system continues to run for some time after being switched off.

### Functional requirements



To use the prevention, the following functional requirements must be met:

- ▷ The vehicle is in idle state or standby state.
- ▷ The vehicle battery is sufficiently charged.

If pre-ventilation is switched on, the vehicle battery will be discharged. Thus, limit the maximum activation time to save the vehicle battery. System can be used again once engine is started or after a short drive.

- ▷ Time and date are set correctly.
- ▷ The air vents are open.

## Switching pre-ventilation on/off

1.  Select the Climate menu icon on the menu bar.
2.  Tap the settings button.
3. "Pre-ventilation"
4. Select the desired setting.

## Departure time

### Principle

Different departure times can be set to ensure a comfortable interior temperature in the vehicle at the time of departure:

- ▷ One-time departure time: the time can be set.  
The system is switched on once.
- ▷ Departure time with weekday: time and day of week can be set.  
On the desired weekdays, the system will be switched on before the set departure time.



The departure time is preselected in two steps:

- ▷ Set the departure time.
- ▷ Set the departure time.



Prevention at the departure time can only be activated once.

Wait at least 10 minutes between setting and activating the departure time and departing at the planned time. This gives the air conditioning sufficient time to bring the vehicle interior to the desired temperature.

## Setting the departure time

1.  To set the departure time, tap the Climate Control menu icon on the menu bar.
2.  Tap the settings button.
3. "Pre-ventilation"
4. "Departure plan"
5. Select the desired departure time.
6. Set the desired departure time.
7. Select the day of the week, as necessary.

## Activating the departure time

1.  To enable the departure time, tap the Climate Control menu icon on the menu bar.
2.  Tap the settings button.
3. "Pre-ventilation"
4. "Departure plan"
5. Activate the desired departure time.

## Activation on the My BMW app

Depending on vehicle equipment, the My BMW App with remote functionality can be used to turn on precooling at a preset departure time or immediately.

## Pre-conditioning through Remote Engine Start

### Principle

Pre-conditioning cools or heats the vehicle interior to a comfortable temperature prior to departure. This system automatically cools, ventilates, and heats depending on the in-

side/outside temperature and set temperature. Snow and ice may be removed more easily.

This system starts the engine automatically and lets it run for a limited time.

## Safety information

### **DANGER**

If the exhaust pipe is blocked or ventilation is insufficient, harmful exhaust gases can pollute the area in and around the vehicle or penetrate the vehicle. The exhaust gases contain pollutants which are colorless and odorless. In enclosed areas or areas with insufficient ventilation, exhaust gases can also accumulate outside of the vehicle. There is a danger to life. Keep the exhaust pipe free and ensure sufficient ventilation. Do not switch on pre-conditioning in enclosed areas or areas with insufficient ventilation, e.g. in enclosed garages.

### **Warning**

When pre-conditioning is in operation, high temperatures can occur underneath the body, for instance caused by the exhaust system. If combustible materials such as leaves or grass come in contact with hot parts of the exhaust system, these materials can ignite. There is a risk of fire, injury, and property damage. Make sure that no combustible materials can come in contact with hot vehicle parts during pre-conditioning, e.g. leaves, grass, natural gas, gasoline, oil or other combustible objects.

## Functional requirements



To use the pre-conditioning, the following functional requirements must be met:

- ▶ The vehicle is in idle state or standby state.
- ▶ The battery is sufficiently charged.

- ▷ The fuel tank is at a sufficient level.
- ▷ The hood is closed.
- ▷ Time and date are set correctly.
- ▷ The air vents are open.

## Enabling the automatic engine start function

The automatic engine start must be enabled before using the system. Otherwise, the engine cannot switch on automatically to air-condition the vehicle interior.

1.  To enable automatic engine starting, tap the Climate Control menu icon on the menu bar.
2.  Tap the settings button.
3. "Pre-conditioning"
4. "Remote Engine Start"
5. "Start engine for climate control"
6. Confirm the legal disclaimer.

## Turning on/turning off the pre-conditioning



### General information

The pre-conditioning turns off automatically after max. 15 minutes for safety reasons.

The pre-conditioning can only be activated twice in a row.

Pre-conditioning can be used again as soon as drive-ready state is activated and then deactivated again.

## Switching on via iDrive

1.  Select the Climate menu icon on the menu bar.
2.  Tap the settings button.
3. "Pre-conditioning"
4. "Start now"

## Switching on/off via vehicle key

Pre-conditioning can be turned on/off using the vehicle key:

1.  Press the lock button on the vehicle key three times within 1 second.  
The engine turns on approx. 3 seconds after the vehicle key is pressed.

To turn off the pre-conditioning, press the button again three times within 1 second.

## Turning off with the Start/Stop button

Pre-conditioning can be turned off directly by pushing the Start/Stop button without depressing the brake pedal.

## Air conditioning for departure time

### Principle

Scheduled departure times can be set up in the system to ensure a comfortable interior temperature in the vehicle at the time of departure:

- ▷ One-time departure time: the time of the scheduled departure can be set.  
Pre-conditioning is turned on once.
- ▷ Departure time with weekday: Time and day of week for the scheduled departure can be set.

The departure time is preselected in two steps:

- ▷ Set the departure time.
- ▷ Activate departure times.

Pre-conditioning activates automatically a few minutes before the set departure time. Pre-conditioning stays on for a short time after the set departure time.

For safety reasons, the air conditioning can only be activated once for the departure time.



Pre-conditioning can be used again as soon as drive-ready state is activated and then deactivated again.

Observe the information about the intended use of the vehicle.



Additional information:

For your own safety, refer to page 9.

## Setting the departure time

1.  To set the departure time, tap the Climate Control menu icon on the menu bar.
2.  Tap the settings button.
3. "Pre-conditioning"
4. "Departure plan"
5. Set the departure time.
6. Select the day of the week, as necessary.

## Activating the departure time

1.  To enable the departure time, tap the Climate Control menu icon on the menu bar.
2.  Tap the settings button.
3. "Pre-conditioning"
4. "Departure plan"
5. Activate the desired departure time.

## Display



The activated pre-conditioning temperature is displayed on the instrument cluster:

The engine runs for the purpose of operating the pre-conditioning. The vehicle is not ready to drive.

## Confirmation signals from the vehicle

Activation of the pre-conditioning is confirmed by the light flashing twice.

The parking light turns on while the pre-conditioning is on.

# Interior equipment

## Vehicle features and options

This chapter describes model-specific equipment, systems, and functions that are currently available, or may become available in the future, even if they are not present in the vehicle.

Additional information:

Vehicle equipment, refer to page 8.

## Integrated universal remote control

### Principle

The integrated universal remote control in the interior mirror can operate remote-controlled systems such as garage doors, alarm systems, or locking systems.

### General information

The integrated universal remote control replaces various hand-held transmitters for remote-controlled systems. To operate the remote control, the buttons on the interior mirror must be programmed with the desired functions.

If possible, do not install the antenna of the remote-controlled system near metal objects to ensure the best possible operation.

### Safety information

#### WARNING

The operation of remote-controlled systems with the integrated universal remote control such as the garage door may result in injury, for example, body parts becoming jammed in a garage door. There is a risk of injury and risk of property damage. Make sure that the travel path of the respective system is clear

during programming and operation. Also follow the safety instructions of the hand-held transmitter.

### Operating elements on the interior mirror

The operating elements on the interior mirror consist of the following elements:



- ▶ Buttons, arrow 1.
- ▶ LED, arrow 2.
- ▶ Hand-held transmitter for remote-controlled system, arrow 3.

### Compatibility



If this icon is printed on the packaging or in the operating instructions for the remote-controlled system, the system is generally compatible with the integrated universal remote control.

Additional questions are answered by:

- ▶ An authorized service center or another qualified service center or repair shop.
- ▶ [www.homelink.com](http://www.homelink.com) on the Internet.

HomeLink is a registered trademark of Gentex Corporation.

For any additional questions, contact an authorized service center or another qualified service center or repair shop.

## Programming the integrated universal remote control

### Functional requirements

To program the integrated universal remote control, the following functional requirements must be met:

- ▶ To ensure optimum range of the integrated universal remote control, the hand-held transmitter's battery must be fully charged at the time of programming.
- ▶ The vehicle is parked within range of the remote-controlled system.
- ▶ There are no persons or objects in the area around the remote-controlled system.
- ▶ Standby state is switched on.

### Programming individual buttons

1. Select desired button on interior mirror:
  - ▶ Program an available button:  
Press the button.
  - ▶ Program a button that is already in use:  
Press and hold the button for approx. 20 seconds.  
The LED on the interior mirror will slowly begin flashing orange.
2. Hold the hand-held transmitter for the remote-controlled system approx. 1 to 3 in/3 to 8 cm away from the buttons on the interior mirror.  
The required distance depends on the hand-held transmitter and can be found in the operating instructions for the remote-controlled system.
3. Press and hold the button on the hand-held transmitter until the LED on the interior mirror illuminates green. Programming is complete.

If programming could not be completed, the LED may react in different ways:

- ▶ LED flashes green: the hand-held transmitter has been detected but programming is not complete. Continue with the specific features for rolling code radio systems.
- ▶ If the LED does not illuminate green after 60 seconds, programming could not be completed. Repeat the programming procedure.

### Special feature of the rolling code wireless system

For systems with a rolling code radio system, the integrated universal remote control and the system also have to be synchronized.

Refer to information on synchronization in the operating instructions for the remote-controlled system.

Synchronization is easier with the aid of a second person.

1. Program the desired button on the interior mirror.
2. Press the synchronize button on the remote-controlled system, e.g., on the garage door.
3. Within 30 seconds, press and hold the programmed button on the interior mirror for approx. 3 seconds.

When synchronization is complete, the programmed function is performed, e.g., opening the garage door.

If the function is not performed, repeat this step up to three times, if necessary, until the synchronization is complete and the programmed function is performed as desired.

### Operation

After programming, the remote-controlled system can be operated with the button on the interior mirror.

Press and hold the desired button on the interior mirror within range of the remote-controlled system until the function activates.

The interior mirror LED illuminates green while the wireless signal is being transmitted.

## Deleting a button assignment

The programming for the interior mirror buttons can be deleted, e.g., before selling the vehicle.

Press and hold the two outer buttons on the interior mirror simultaneously for approx. 10 seconds until the LED flashes green.

All stored button assignments will be deleted.

## Sun visor

### Glare shield

To protect against glare, fold the sun visor up or down.

### Glare shield from the side

#### Folding the sun visor out

To prevent glare from the side window, proceed as follows:

1. Fold down the sun visor.
2. Detach the sun visor from its mount and swing it toward the side window.

#### Folding the sun visor in

Proceed in the reverse order to close the sun visor.

### Vanity mirror

A vanity mirror is located in the sun visor behind a cover.

## Sockets

### Principle

The socket can be used for electronic devices when the standby or drive-ready state is switched on.

### General information

The total load of all sockets must not exceed 140 watts at 12 volts.

Do not damage the socket by using unsuitable connectors.

### Safety information

#### **WARNING**

Devices and cables in the unfolding area of the airbags such as portable navigation devices can hinder the unfolding of the airbag or be thrown around in the car's interior while unfolding. There is a risk of injury and risk of property damage. Make sure that devices and cables are not in the airbag's area of unfolding.

#### **WARNING**

If metal objects fall or are plugged into electronic interfaces, e.g., sockets or USB ports, these objects can cause a short circuit and destroy the interface. There is a risk of injury and risk of property damage. Make sure to prevent metal objects from falling or being plugged into electronic interfaces. Close the socket again after use, e.g., with the socket cover.

**⚠ WARNING**

Battery chargers that charge the vehicle battery from sockets in the vehicle may overload or damage the 12V electrical system. There is a risk of injury and risk of property damage. Only connect battery chargers for the vehicle battery to the jump-start terminals in the engine compartment.

## Front center console

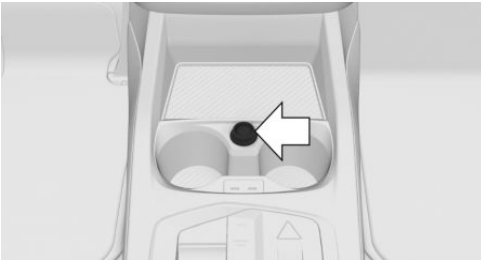

A socket is provided on the front center console under a cover. Pull off the cover before using the socket.

## USB port

### Principle

Mobile devices can be charged via USB cable using the USB port.

### General information

The range of functions is indicated by an icon on the USB port.

Icon	Meaning
	Compatible mobile devices can be supplied with charge current.

## Safety information

**⚠ WARNING**

If metal objects fall or are plugged into electronic interfaces, e.g., sockets or USB ports, these objects can cause a short circuit and destroy the interface. There is a risk of injury and risk of property damage. Make sure to prevent metal objects from falling or being plugged into electronic interfaces. Close the socket again after use, e.g., with the socket cover.

## Front center console

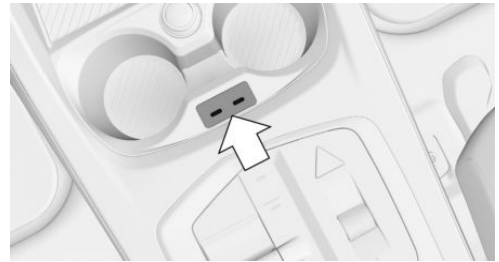

Two USB ports are located on the front center console.

These USB ports have the following characteristics:

- ▷ USB port Type C.
- ▷ For charging mobile devices.
- ▷ Charge current: max. 3 A.

## Rear center console



Two USB ports are located in the rear center console.

These USB ports have the following characteristics:

- ▶ USB port Type C.
- ▶ For charging mobile devices.
- ▶ Charge current: max. 3 A.

## Connecting mobile devices

When connecting the mobile device to the USB port, note the following:

- ▶ Do not use force when plugging the connector into the USB port.
- ▶ If necessary, use a flexible adapter cable.
- ▶ Protect the mobile device from mechanical damage.
- ▶ Do not expose the mobile device to extreme environmental conditions, e.g., very high temperatures. See the device operating instructions.

## Incompatible USB devices

The following mobile USB devices are not suitable for connection to the vehicle:

- ▶ Devices such as fans or bulbs.
- ▶ Devices with a power consumption of more than 3 A at 5 V.

## Wireless charging tray

### Principle

The wireless charging tray is used to wirelessly charge Qi-certified smartphones.

### General information

Different charging powers, e.g., fast charging, are supported depending on the smartphone.

The integrated fan cools the smartphone being charged.

When inserting the smartphone to be charged, make sure that there is nothing between the smartphone to be charged and the wireless charging tray.

⚡ The charging process is shown by the charging indicator on the control display.

## Safety information

### WARNING

When charging a device in the Wireless Charging tray, any metal objects in the tray with this device may become very hot. Storage media or electronic cards, e.g., chip cards, cards with magnetic strips, or cards for transmitting signals, may not function correctly when placed together on the tray with the device. There is a risk of injury and risk of property damage. When charging mobile devices, make sure there are no objects on the tray with the device.

## Overview

Wireless charging tray crosswise in center console:



- 1 Wireless charging tray
- 2 Fan

## Functional requirements

To use the wireless charging tray, the following functional requirements must be met:

- ▶ The smartphone being charged must be Qi-certified.
- ▶ Standby state is switched on.
- ▶ The charging function is on.
- ▶ The smartphone cannot exceed maximum dimensions of approx. 6.69 x 3.34 x 0.7 in/170 x 85 x 18 mm.
- ▶ Protective sleeves and covers must be suitable for wireless charging.
- ▶ The smartphone being charged has been placed crosswise in the center of the wireless charging tray. The smartphone display is facing up.

## Activating/deactivating charging

To activate/deactivate charging, go through the menu as follows: Apps menu / "Vehicle" / "System settings" / "Wireless Charging tray" / "Wireless charging".

## Inserting a smartphone

Place the smartphone crosswise in the center of the wireless charging tray, with the display facing up.

## Forgotten warning

### General information

A warning may be issued if a Qi-certified smartphone was forgotten in the wireless charging tray when leaving the vehicle.

The forgotten warning is displayed in the instrument cluster.

### Enable/Disable Forgotten Warning

To activate/deactivate the Forgotten Warning, go through the menu as follows: Apps menu / "Vehicle" / "System settings" / "Wireless Charging tray" / "Mobile phone reminder".

## System limits

The charge current may be reduced or charging may be temporarily interrupted in the wireless charging tray in the following situations:

- ▶ Due to excessive temperatures of the wireless charging tray and smartphone.
- ▶ If there are objects between the smartphone and wireless charging tray.
- ▶ If storage media or electronic cards, e.g., chip cards, cards with magnetic stripes, or cards for signal transmission, are located between the smartphone and wireless charging tray.
- ▶ Due to protective sleeves and covers that exceed a thickness of 0.07 in/2 mm.
- ▶ Due to protective sleeves and covers made of unsuitable material, e.g., with magnetic parts.
- ▶ Due to add-on parts for the smartphone, e.g., holders.
- ▶ By configuring the smartphone settings, e.g., for charging. Follow the instructions given on the control display and smartphone, as applicable.

## Interior camera

### Principle

The interior camera can be used to record the vehicle interior.

Before the interior camera can be used for the first time, the recording function and, if necessary, data transfer must be enabled on the control display. Additional activation may be required for some system functions.

Two infrared light sources next to the camera lens illuminate while the interior camera is active. Infrared light sources may be visible, depending on lighting conditions.

The interior camera can provide the following functions:

- ▶ Interior camera.  
Media can be recorded, saved, and played.
- ▶ Remote Inside View.  
The vehicle interior can be recorded using the My BMW App.
- ▶ Anti-Theft Recorder.  
If the alarm system is triggered, the vehicle interior is automatically recorded. Recordings can also be played using the My BMW App.

Follow applicable legal requirements when using this system.

### Data protection

#### General information

The permissibility of making and evaluating recordings for the interior camera depends on the applicable regulations of the country in which the system is to be used. The user is responsible for the use of the system and compliance with the respective regulations.

The vehicle manufacturer recommends that you verify there are no statutory or regulatory restrictions on using the system in your region or country prior to initial use. In addition, the

laws with respect to use of the system should be verified in regular intervals, especially when borders are frequently crossed.

Other users and occupants of the vehicle must be informed about the system. In addition, information about the system is required when handing off the vehicle.

#### Data transfer and data storage

Whether recording data will be sent or stored depends on the recording function.

The following applies for the interior camera function:

- ▶ Data is sent to a mobile device. It must be possible to connect to the vehicle over Wi-Fi.
- ▶ Data is saved to the vehicle and assigned to the BMW ID or driver profile.

The following applies for Remote Inside View:

- ▶ Data is sent to mobile devices via the My BMW App. A connection to the ConnectedDrive account is required.
- ▶ Data is saved to the My BMW App and, after data is sent, to the mobile device.

The following applies for the Anti-Theft Recorder:

- ▶ Data is sent to mobile devices via the My BMW App. A connection to the ConnectedDrive account is required.
- ▶ Data is saved to the vehicle and, after data is sent, to the mobile device.

More information on the scope and content of data processing is available online in the ConnectedDrive privacy notices or service descriptions.

#### Occupying the seats

The interior camera is also used to detect occupied seats.

The interior camera turns on automatically at regular intervals when all doors are closed. This system analyzes the vehicle interior to

detect which seats are occupied. No media recordings are made in the process.

## Overview

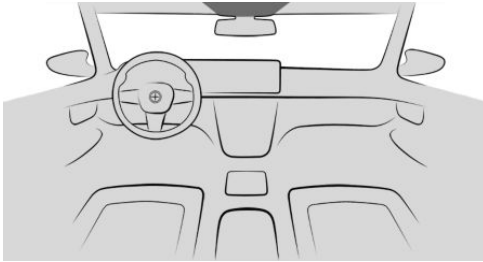

The interior camera is located in the headliner. Additional information:

Around the headliner, refer to page 33.

## Functional requirements

To use the interior camera function, the following functional requirements must be met:

- ▶ The Privacy Policy has been accepted.
- ▶ The camera is activated.

To send recordings to mobile devices, the following functional requirements must be met:

- ▶ Data transfer is activated.
- ▶ A mobile device is connected to the vehicle via Wi-Fi.

The following functional requirements apply for the Remote Inside View and Anti-Theft Recorder functions:

- ▶ The Privacy Policy has been accepted.
- ▶ The My BMW App is installed on the mobile device.
- ▶ The My BMW App is linked to the ConnectedDrive account.
- ▶ The vehicle is parked and locked.
- ▶ The Anti-Theft Recorder can only be used if vehicle is equipped with an alarm system.

Ensure that the faces of occupants are visible and are not partially or completely covered, for instance by face masks.

Additional information:

Data protection, refer to page 60.

## Activating/deactivating interior camera

The interior camera can record and send data when activated, then be deactivated.

1. Go through the menu as follows: Apps menu / "All" / "Interior camera" / "Settings".
2. Select the desired setting.

## Interior camera

### Recording mode

Recording mode	Function
"Single photo"	Shortly after triggering, a photo will be taken.
"Smile"	When the system detects a smile, a picture will be taken.
"Self-timer (3 sec.)"	After the timer has expired, a photo will be taken.
"Burst mode"	Shortly after triggering, a series of pictures will be taken.

### Take picture

1. To take a photo, go through the menu as follows: Apps menu / "All" / "Interior camera" / "Camera".
2. Select the desired recording mode.
3. Trigger a photo.

Depending on the recording mode selected, photos are taken shortly after being triggered, when a smile is detected, or when the timer elapses.

For burst shots, the series of pictures will be displayed as a preview.

## Recording video

1. To take a video, go through the menu as follows: Apps menu / "All" / "Interior camera" / "Camera".
2. Select the recording mode for video recording.
3. Start the video recording.  
You can only record video for a certain time.

## Displaying and managing recordings

Saved recordings can be played, sent, and deleted in the vehicle.

With some national-market versions, recordings are only shown on the control display when the vehicle speed is less than approx. 2 mph/3 km/h for safety reasons.

1. Go through the menu as follows: Apps menu / "All" / "Interior camera" / "Gallery".
2. Select the desired recording.
3. Select the desired setting.

Scan the QR code shown on the control display to send recordings to a mobile device. The recording is transferred when the pop-up on the mobile device is opened. The mobile device must be connected to the vehicle via WLAN.

## Settings

1. To configure the settings for the interior camera, go through the menu as follows: Apps menu / "All" / "Interior camera" / "Settings".
2. Select the desired setting.

## Remote Inside View

With Remote Inside View, recordings of the vehicle interior can be played on a mobile device using the My BMW App. The vehicle interior can be checked, e.g., for forgotten items.

The function is not suitable for monitoring people or animals left behind.

## Anti-Theft Recorder

The Anti-Theft Recorder automatically records the vehicle interior when the alarm system is triggered. The My BMW App issues a notification when recordings are being taken. The recording can be shown on a mobile device.

Up to three recordings can be saved to the vehicle and synchronized with the My BMW App. If the vehicle is reset to factory settings, recordings saved to the vehicle are deleted.

# Storage compartments

## Vehicle features and options

This chapter describes model-specific equipment, systems, and functions that are currently available, or may become available in the future, even if they are not present in the vehicle.

Additional information:

Vehicle equipment, refer to page 8.

## Storage compartments

### Principle

The vehicle has various options for storing or stowing objects, e.g., the glove compartment or door storage compartments.

### Safety information

#### **WARNING**

When driving, loose items or devices connected to the vehicle with a cable, i.e., mobile phones, may be thrown around the vehicle, e.g., in the event of an accident or when braking or performing evasive maneuvers. There is a risk of injury and risk of property damage. Secure loose objects or devices that are connected to the vehicle via a cable.

#### **WARNING**

Breakable objects such as glass bottles or glasses can break in the event of an accident, braking or an evasive maneuver. Broken glass can be scattered in the car's interior. There is a risk of injury and risk of property damage. Do not use any breakable objects while driving. Only stow breakable objects in closed storage compartments.

#### **WARNING**

Open flaps of the storage compartments, e.g., glove compartment or center armrest, protrude into the interior when folded open and may be in the way of an airbag that deploys. In addition, objects in the open storage compartment can be thrown into the vehicle interior during the trip, for instance, in the event of an accident or when braking or making an evasive maneuver. There is a risk of injury. Always close storage compartments immediately after use.

#### **WARNING**

Anti-slip pads such as anti-slip mats can damage the dashboard. Attached objects could come loose. There is a risk of injury and risk of property damage. Do not use anti-slip pads.

## Glove compartment

### Overview

The glove compartment is located at the bottom of the instrument panel on the front passenger's side.

## Opening the glove compartment

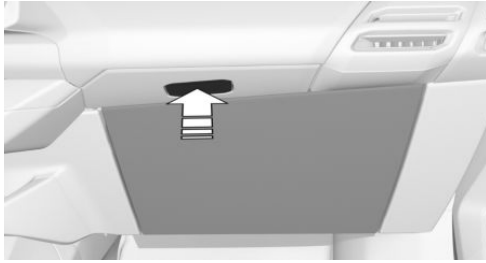

To open the glove compartment, press the button above the glove compartment.

## Closing the glove compartment

To close the glove compartment, press the glove compartment lid down until it engages.

## Front center armrest

### Overview

A storage compartment is provided in the center armrest between the seats.

### Opening the center armrest

To open the center armrest, proceed as follows:

1. Press the button on the center armrest, ar-row.

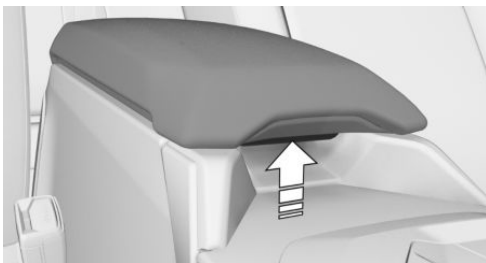

2. Open the center armrest lid.

## Closing the center armrest

To close the center armrest, press the center armrest lid down until it engages.

## Rear center armrest

### Folding down the center armrest

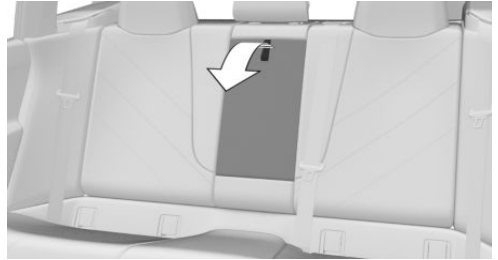

To fold down the center armrest, fold the center armrest forward.

## Front cup holder

### Safety information

#### **WARNING**

Unsuitable containers in the cup holders may damage the cup holders or be thrown about the car's interior in the event of an accident, an evasive maneuver, or forceful braking. Spilled liquids can distract from the surrounding traffic conditions, lead to an accident and damage vehicle components. Hot drinks can damage the cup holder or lead to scalding. There is a risk of injury and risk of property damage. Do not force objects into the cup holder. Make sure that drink containers are secured firmly in the cup holder. Use lightweight, shatterproof, and sealable containers. Clean up spilled liquids immediately. Do not transport hot beverages.

## Overview

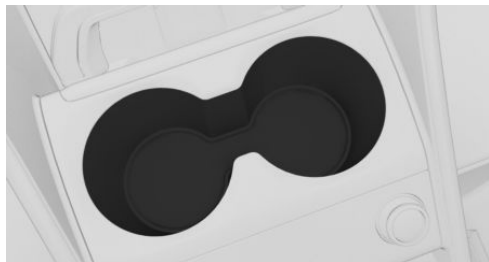

The front center console includes two cup holders.

## Rear cup holder

### Safety information

#### **WARNING**

Unsuitable containers in the cup holders may damage the cup holders or be thrown about the car's interior in the event of an accident, an evasive maneuver, or forceful braking. Spilled liquids can distract from the surrounding traffic conditions, lead to an accident and damage vehicle components. Hot drinks can damage the cup holder or lead to scalding. There is a risk of injury and risk of property damage. Do not force objects into the cup holder. Make sure that drink containers are secured firmly in the cup holder. Use lightweight, shatterproof, and sealable containers. Clean up spilled liquids immediately. Do not transport hot beverages.

## Overview

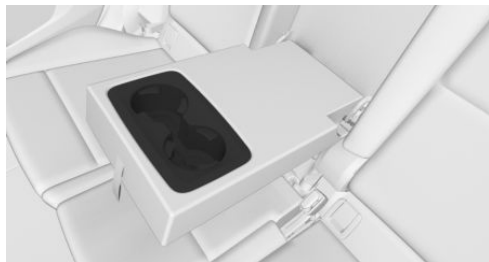

Two cup holders are provided in the rear center armrest.

Before using the cup holder, fold the center armrest forward.

## Coat hooks

### Safety information

#### **WARNING**

Clothing articles on the coat hooks can obstruct the view while driving. There is a risk of accident, injury, and property damage. When suspending clothing articles from the coat hooks, ensure that they will not obstruct the driver's view.

#### **WARNING**

Improper use of the coat hooks can lead to a risk of objects flying about during braking and evasive maneuvers. There is a risk of injury and risk of property damage. Only hang lightweight objects, for instance clothing articles, from the coat hooks.

## Overview

The coat hooks are located at the back of the headliner.

## Swiveling out the coat hook

To swivel out the coat hook, push on the side edge.

Turn the coat hook until it engages audibly.

# Cargo area

## Vehicle features and options

This chapter describes model-specific equipment, systems, and functions that are currently available, or may become available in the future, even if they are not present in the vehicle.

Additional information:

Vehicle equipment, refer to page 8.

## Loading

### Principle

When loading the vehicle, items and cargo must be stowed and secured properly. Do not exceed the permissible weights and loads.

### Safety information

#### **WARNING**

High gross vehicle weight can overheat the tires, damage them internally and cause a sudden tire pressure loss. Driving characteristics may be negatively impacted, reducing directional stability, lengthening the braking distances and changing the steering response. There is a risk of accident, injury, and property damage. Note the permissible load-carrying capacity of the tires, and do not exceed the gross vehicle weight.

#### **WARNING**

When driving, loose items or devices connected to the vehicle with a cable, i.e., mobile phones, may be thrown around the vehicle, e.g., in the event of an accident or when braking or performing evasive maneuvers. There is a risk of injury and risk of property damage.

Secure loose objects or devices that are connected to the vehicle via a cable.

#### **WARNING**

Improperly stowed objects can slip and be thrown into the car's interior, for instance in the event of an accident, braking or an evasive maneuver. Vehicle occupants can be hit and injured. There is a risk of injury and risk of property damage. Stow and secure objects and cargo properly.

#### **NOTICE**

Fluids in the cargo area can cause damage. There is a risk of property damage. Make sure that no fluids leak in the cargo area.

## Steps for Determining Correct Load Limit

1. Locate the statement "The combined weight of occupants and cargo should never exceed XXX kg or XXX lbs." on your vehicle's placard.
2. Determine the combined weight of the driver and passengers that will be riding in your vehicle.
3. Subtract the combined weight of the driver and passengers from XXX kg or XXX lbs.
4. The resulting figure equals the available amount of cargo and luggage load capacity. For example, if the "XXX" amount equals 1400 lbs. and there will be five 150 lb passengers in your vehicle, the amount of available cargo and luggage load capacity is 650 lbs.  $(1400 - 750 (5 \times 150) = 650 \text{ lbs.})$

- Determine the combined weight of luggage and cargo being loaded on the vehicle. That weight may not safely exceed the available cargo and luggage load capacity calculated in Step 4.
- If your vehicle will be towing a trailer, load from your trailer will be transferred to your vehicle. Consult this manual to determine how this reduces the available cargo and luggage load capacity of your vehicle.

## Payload



The maximum payload is the sum of the weight of the occupants and the cargo.

The greater the weight of the occupants, the less cargo that can be transported.

## Stowing and securing cargo

To stow and secure cargo, note the following:

- ▶ Cover sharp edges and corners on the cargo.
- ▶ If stowing sufficiently large items in the cargo area, fold down the rear seat backrests completely.
- ▶ Stow particularly heavy cargo as far forward as possible, directly behind and below the rear seat backrests. When the rear seat is not occupied, secure each of the outer seat belts in the opposite buckle.

## Multifunction hook

### Principle

Lightweight objects can be hung on the multifunction hooks in the cargo area.

### Safety information

#### WARNING

Improper use of the multifunction hooks can lead to a risk of objects flying about, e.g., during braking and evasive maneuvers. There is a risk of injury and risk of property damage. Only hang lightweight objects from the multifunction hooks. Heavy luggage in the cargo area must be properly secured.

### Overview

A multifunction hook is provided on the right side of the cargo area.

## Net

Depending on vehicle equipment, a net is provided on the right side of the cargo area.

Smaller items can be stored behind the net. To transport larger objects, slide the net down.

## Storage compartment on the right side

There is a storage compartment on the right side of the cargo area.

## Storage compartment on the left side

### General information

There is a storage compartment on the left side of the cargo area.

### Opening the storage compartment

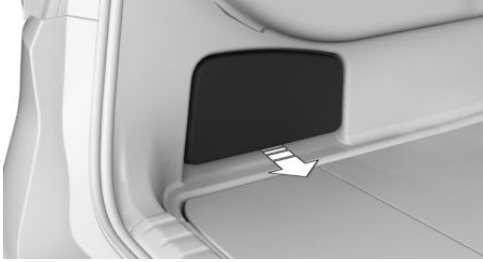

To open the storage compartment, grasp the lower edge of the cover and pull it off.

- ▷ Do not use the cargo area floor to separate the cargo area and vehicle interior in the sense of a luggage net.
- ▷ Only use the cargo area floor in the folded-up position when the rear seat backrests are folded up and locked.
- ▷ Fold down the cargo area floor before driving off.
- ▷ Always secure cargo against slipping, using straps, belts and lashing eyes, for instance.

### NOTICE

The storage space under the cargo area floor is only suitable for soft objects. Hard objects may result in damage to the vehicle electrical system in the event of an accident. There is a risk of property damage. Only stow soft objects under the cargo area floor.

## Cargo area floor

### Principle

To stow cargo, a storage compartment is provided under the cargo area floor. The cargo area floor can be opened and removed as necessary.

### Safety information

#### WARNING

Improper use of the cargo area floor can lead to a risk of objects flying about during braking and evasive maneuvers, for example. There is a risk of injury and risk of property damage.

## Opening the storage compartment

1. To open the storage compartment, lift the cargo area floor by the handle.

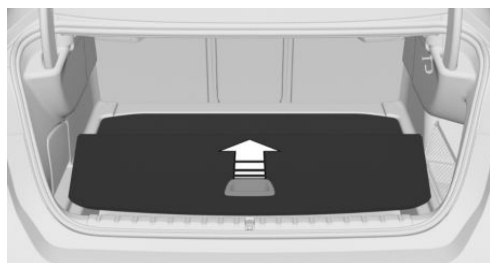

2. Fold the cargo area floor together, toward the front.

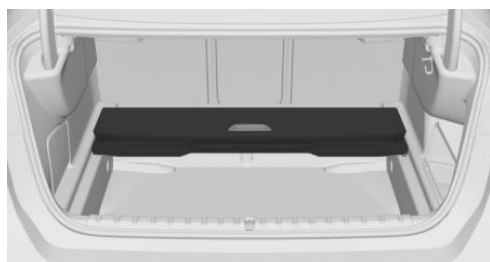

## Closing the storage compartment

To close the storage compartment, fold the cargo area floor backward and push it down.

### Fold up the cargo area floor

Without mild hybrid technology:

The cargo area floor can be folded up as follows:

1. Fold the cargo area floor together, toward the front.
2. Fold the cargo area floor up.

With mild hybrid technology:

The cargo area floor cannot be folded up. Do not fold the cargo area floor up.

Additional information:

Mild hybrid technology, refer to page [363](#).

## Removing the cargo area floor

Without mild hybrid technology:

The cargo area floor can be removed as follows:

1. Lift the cargo area floor using the handle.
2. Grab the cargo area floor on the left and right.
3. Pull the cargo area floor to the left or right successively, arrows 1.

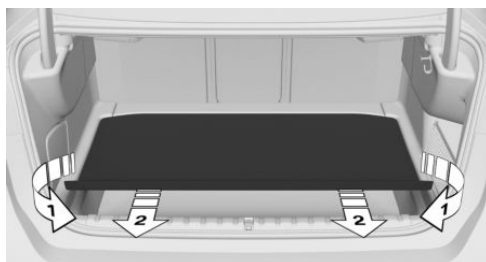

4. Pull the cargo area floor backward out of the mounts, arrows 2.
5. Fold the cargo area floor together toward the front and remove.

With mild hybrid technology:

The function is not available. Do not remove the cargo area floor.

## Inserting the cargo area floor

Proceed in reverse order to insert the cargo area floor:

1. Place the folded cargo area floor flat against the mounts.
2. Push the cargo area floor forward into the mounts. The cargo area floor engages noticeably.

## Enlarging the cargo area

### Principle

The cargo area can be enlarged by folding down the rear seat backrests.

## General information

The rear seat backrest is divided at a ratio of 40–20–40. The side rear seat backrests and the center section can be folded down separately.

The rear seat backrests can be folded down from the cargo area. The center section can be separately folded down from the rear.

## Safety information

### WARNING

Vehicle parts can be damaged or body parts jammed when folding down the rear seat backrest. There is a risk of injury or risk of property damage. Make sure that the area of movement of the rear seat backrest including head restraint is clear when folding down.

### WARNING

If a rear seat backrest is not locked, unsecured cargo can be thrown about the car's interior; for instance, in the event of an accident, braking or an evasive maneuver. There is a risk of injury. Make sure that the rear seat backrest is locked after folding it back.

### WARNING

The stability of the child restraint system is limited or compromised with incorrect seat setting or improper installation of the child seat. There is a risk of injury and danger to life. Make sure that the child restraint system fits securely against the backrest. If possible, adjust the backrest tilt for all affected backrests and correctly adjust the seats. Make sure that seats and backrests are securely engaged or locked. If possible and necessary, adjust the height of the head restraints or remove them.

## Folding down the rear seat backrest from the cargo area

To fold in the rear seat backrests, proceed as follows:

1. Release the belt lock on the center seat belt in the rear using the buckle tongue on another seat belt.
2. Insert the upper buckle tongue, arrow 1, into the gap of the belt feed.
3. Insert the lower buckle tongue, arrow 2, into the provided mount on the rear shelf.

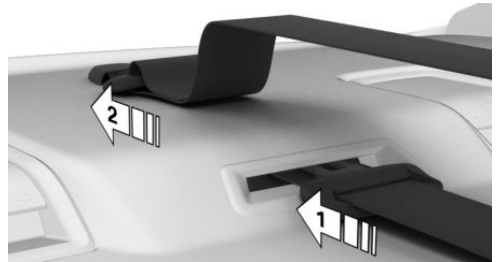

4. Push the corresponding head restraint down as far as it will go.
5. In the cargo area, pull the corresponding lever to unlock the rear seat backrest. The

unlocked rear seat backrest moves forward slightly.

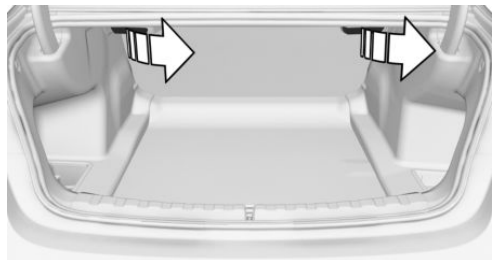

6. Fold the rear seat backrest forward.



## Folding down the center section

To fold down the center section, proceed as follows:

1. Fold down the center head restraint.
2. Pull the lever and fold the center section forward.

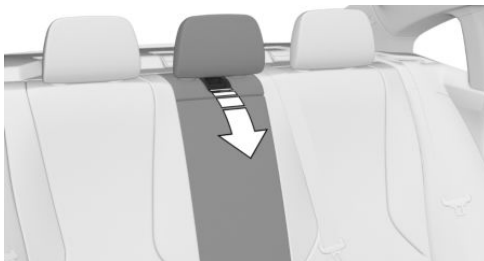

## Folding back the backrest

To fold back the rear seat backrests, proceed as follows:

1. Return the rear seat backrest to the seat position and engage it.
2. Loosen the buckle tongue from the mount on the rear shelf.
3. Insert the buckle tongue into the belt lock on the center seat belt. The buckle tongue should engage audibly.



# Things to remember when driving

## Vehicle features and options

This chapter describes model-specific equipment, systems, and functions that are currently available, or may become available in the future, even if they are not present in the vehicle.

Additional information:

Vehicle equipment, refer to page 8.

## Break-in procedures

### General information

Moving parts need to interact with one another smoothly.

The following break-in procedures will help the vehicle achieve a long service life and good efficiency.

During break-in, do not use the Launch Control.

### Safety information

#### WARNING

Due to new parts and components, safety and driver assistance systems can react with a delay. There is a risk of accident, injury, and property damage. After installing new parts or with a new vehicle, drive conservatively and intervene early if necessary. Observe the break-in procedures of the respective parts and components.

## Engine, transmission, and axle drive

### Up to 1,200 miles/2,000 km

Up to 1,200 miles/2,000 km, do not exceed the maximum engine speed and vehicle speed:

- ▶ For gasoline engine: 4,500 rpm and 100 mph/160 km/h.

Avoid full throttle or kickdown under all circumstances.

### From 1,200 miles/2,000 km

From 1,200 miles/2,000 km, the engine speed and the vehicle speed can be gradually increased.

### Tires

Tire traction is not optimal due to manufacturing circumstances when tires are brand new.

Drive conservatively for the first 200 miles/300 km.

### Brake system

Brake disks and brake pads must be broken in to avoid the conditions that can lead to brake noise. Drive cautiously for the first approx. 300 miles/500 km.

### Following part replacement

The same break-in procedure should be observed if any of the components mentioned above have to be renewed.

## General driving notes

### Closing the trunk lid

#### Safety information

##### **WARNING**

An open trunk lid protrudes from the vehicle and can endanger occupants and other road users or damage the vehicle in the event of an accident, braking or evasive maneuvers. In addition, exhaust gas or water may enter the vehicle interior. There is a risk of injury and risk of property damage. Do not drive with the trunk lid open.

#### Driving with the trunk lid open

Drive with the trunk lid closed. If it is necessary to drive with the trunk lid open, note the following:

- ▶ Close all windows and the glass sunroof.
- ▶ Greatly increase the blower output.
- ▶ Drive moderately.
- ▶ Secure the trunk lid, e.g., with a tensioning belt.

#### Ground clearance

##### **NOTICE**

If the ground clearance is insufficient, e.g., underground garage entrances, speed bumps, or curbs, the ground may come into contact with vehicle parts, e.g., spoiler, and the underbody. There is a risk of property damage. Ensure that there is sufficient ground clearance available. Adjust your driving style to the respective conditions.

## Driving at high speeds

##### **WARNING**

Damage to vehicle components can negatively impact handling at high speeds. This includes, among other things, tires, underbody and parts for improving aerodynamics. There is a risk of accident, injury, and property damage. Have damage corrected by an authorized service center or another qualified service center or repair shop. Do not drive at high speeds until the damage is corrected.

## Hot exhaust system

##### **WARNING**

High temperatures can occur underneath the body, for instance caused by the exhaust system, while driving. Contact with the exhaust system can cause burns. There is a risk of injury. Do not touch the exhaust system, including the exhaust pipe, when hot.

##### **Warning**

If combustible materials such as leaves or grass come in contact with hot parts of the exhaust system, these materials can ignite. There is a risk of fire and an injury hazard. Do not remove the heat shields installed and never apply undercoating to them. Make sure that no combustible materials can come in contact with hot vehicle parts while driving, in Neutral or during parking.

## Exhaust gas particulate filter

### Principle

The exhaust gas particulate filter collects soot particles. The soot particles are burned at high

temperatures to clean the exhaust gas particulate filter as necessary.

Depending on vehicle equipment and national-market version, the vehicle is equipped with an exhaust particulate filter. For more information on the exhaust particulate filter, contact an authorized service center or another qualified service center or repair shop.

The following may occur when cleaning for several minutes:

- ▶ The combustion engine may not run as smoothly for a short time.
- ▶ A somewhat higher RPM is necessary to reach usual power development.
- ▶ Fuel consumption may be higher. The higher fuel consumption is included as mean value in the display for the current consumption.
- ▶ The exhaust system is emitting a small amount smoke, even after the engine is shut off.
- ▶ There is audible noise, e.g., radiator fan is running, even several minutes after the engine is shut off.

Overrun of the radiator fan for several minutes is normal even after short trips.

## Condensation in drive system

Various driving profiles ensure that the drive system functions properly. A driving style with consistently low loads can negatively affect overall functionality, e.g., condensation forming in the drive system. Occasionally running the engine longer with higher loads can counteract this.

If condensation has formed in the drive system, a corresponding Check Control message appears. In this case, on the next drive outside of town, proceed as follows for approx. 30 minutes:

- ▶ Deactivate the speed control system.
- ▶ Activate Sport Mode via My Modes.
- ▶ If possible, drive at varying speeds.

Additional information:

My Modes, refer to page 126.

## Driving through water

### General information

When driving through water, follow the following:

- ▶ Only drive through when the combustion engine is running.
- ▶ To prevent the combustion engine from being switched off by the Auto Start/Stop function, engage selector lever position S or L, depending on vehicle equipment.
- ▶ The combustion engine also does not shut off in selector lever position R.
- ▶ Only drive through calm water.
- ▶ Drive through water only up to a depth of max 9.8 in/25 cm.
- ▶ Drive through water at a maximum of walking speed, up to 3 mph/5 km/h.

Additional information:

Auto Start/Stop function, refer to page 117.

## Safety information

### NOTICE

When driving too quickly through deep water, the water can penetrate the engine compartment, the electrical system, or the transmission. There is a risk of property damage. When driving through water, do not exceed the maximum indicated water level and the maximum speed for driving through water.

## Braking safely

### General information

The vehicle is equipped with an Antilock Braking System as a standard feature. Perform emergency braking as required by the situa-

tion. To achieve the best possible braking assistance, do not reduce the pressure on the brake pedal during full braking.

Steering is still responsive. You can still avoid any obstacles with a minimum of steering movement.

Sounds from the hydraulic circuits indicate that the Antilock Braking System is regulating.

## Objects in the travel path of the pedals

### **WARNING**

Objects in the driver's footwell can limit the pedal travel or block a depressed pedal. There is a risk of accident, injury, and property damage.

- ▷ Stow objects in the vehicle such that they are secured and cannot enter into the driver's footwell.
- ▷ Use (carpet) floor mats that are suitable for the vehicle and can be securely attached to the floor.
- ▷ Do not use loose floor mats, and do not layer multiple floor mats on top of one another.
- ▷ Make sure that there is sufficient clearance for the pedals.
- ▷ Make sure that floor mats are securely reattached after removing them, e.g., when cleaning.

## Pedal feel when driving off

After turning on drive-ready state from idle state, the pedal may feel unusual, e.g., the pedal travel path may feel short or long. After the brake pedal has been fully released, the pedal will feel as usual again.

## Driving in wet conditions

In case of wet roads, exposure to road salt or in heavy rain, gently depress the brake pedal

every few kilometers. Ensure that this action does not endanger other road users.

The heat generated while braking dries brake disks and brake pads and protects them against corrosion.

In this way the brake power will be available when you need it.

## Hills

### General information

Drive long or steep downhill gradients in the gear that requires least braking effort. Otherwise, the brake system may overheat and reduce braking effect.

You can increase the engine braking effect by downshifting, going all the way to first gear, if needed.

### Safety information

#### **WARNING**

Light but constant pressure on the brake pedal can lead to high temperatures, brake wear, and even failure of the brake system. There is a risk of accident, injury, and property damage. Avoid placing excessive load on the brake system.

#### **WARNING**

In Neutral or with drive-ready state switched off, safety functions, for instance engine braking effect, braking assistance and steering assistance, may be restricted or not available. There is a risk of accident, injury, and property damage. Do not attempt to drive in Neutral or with drive-ready state switched off.

## Brake disk corrosion

Corrosion on the brake disks and soiling of the brake pads are increased under the following circumstances:

- ▶ Low mileage.
- ▶ Extended stationary periods.
- ▶ Low load.
- ▶ Aggressive, acidic, or alkaline cleaning agents.

Corrosion buildup on the brake disks will cause a pulsating effect on the brakes when braking slowly - generally this cannot be corrected.

## Condensation water under the parked vehicle

Condensation may form in the vehicle air-conditioning system.

Condensation leaking under the vehicle is due to technical reasons and does not constitute a malfunction.

## Driving on racetracks

### General information

Before and after driving on a racetrack, have the vehicle checked by an authorized service center or another qualified service center or repair shop.

Higher mechanical and thermal loads during racetrack operation lead to increased wear. Use of the vehicle in M sport or motorsport type competition is an improper use of the vehicle and may affect your warranty coverage. Please consult the New Vehicle Limited Warranty Booklet for further information on warranty matters.

## Safety information

### **WARNING**

The vehicle is not designed for use in M Sport or motorsport-like competition. There is a risk of accident, injury, and property damage. Do not use the vehicle for motorsport or motorsport-like competitions.

## Sport tires

The vehicle manufacturer recommends using special sport tires, e.g., high-performance tires. Sports tires are matched to the special requirements of a sporty driving style. For more information on sport tires, contact an authorized service center or another qualified service center or repair shop.

## Roof bars

### Principle

Roof bars are devices that are mounted on the vehicle to facilitate the transport of luggage.

When driving with a roof bar, various specifications, e.g., correct load, must be followed.

### General information

Roof bars recommended by the manufacturer of the vehicle are available as optional accessories.

## Safety information

### **WARNING**

When driving with a roof load, e.g., roof bars, the vehicle's center of gravity is higher. This increases the risk of the vehicle tipping in critical driving situations. There is a risk of accident, injury, and property damage. Drive

with roof load only with activated Dynamic Stability Control.

- ▶ Do not let objects project into the swiveling range of the trunk lid.
- ▶ Drive carefully. Do not drive off or brake suddenly or take corners at speed.

## Roof rack mounts

The roof bar mounts are located under the covers in the roof strip above the doors.

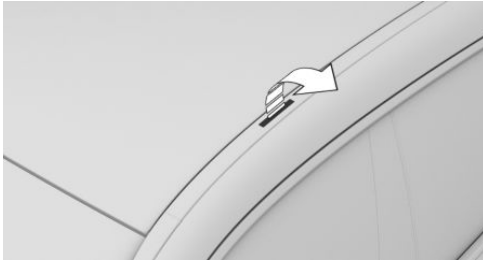

Open the cover outward.

## Installation

Follow the installation instructions for roof bars when installing.

Be sure that adequate clearance is maintained for tilting and opening the glass sunroof.

## Loading

Because roof racks raise the vehicle's center of gravity when loaded, they have a significant effect on vehicle handling and steering.

When loading and driving, note the following:

- ▶ Do not exceed the permissible roof load, axle load, and gross vehicle weight.
- ▶ Distribute the roof load evenly.
- ▶ The roof load should not extend past the vehicle sides.
- ▶ Always place the heaviest items on the bottom.
- ▶ Secure roof luggage firmly, for instance using tie-down straps.

# Saving fuel

## Vehicle features and options

This chapter describes model-specific equipment, systems, and functions that are currently available, or may become available in the future, even if they are not present in the vehicle.

Additional information:

Vehicle equipment, refer to page [8](#).

## Reducing fuel consumption

### Principle

The vehicle features numerous technologies that reduce energy consumption and maximize range.

There are some actions you can take to change your fuel consumption and environmental impact:

- ▶ Remove unnecessary cargo from the vehicle.
- ▶ Remove add-on parts, e.g., a rear carrier, after use.
- ▶ Close the windows and glass sunroof while driving.
- ▶ Check the tire pressure regularly and increase it as necessary.
- ▶ Shut off the engine if the vehicle is to remain stationary for a longer period.
- ▶ Select Efficient Mode or Personal Mode.
- ▶ Practice anticipatory driving and let the vehicle coast more often.
- ▶ Deactivate functions that are not required, e.g., rear window heating.
- ▶ Have the vehicle serviced regularly.

## Coasting

### Principle

The drive system allows the vehicle to coast with reduced consumption and minimal deceleration in selector lever position D. This driving condition is referred to as coasting. This reduces fuel consumption.

Vehicles with mild hybrid technology do not consume fuel when coasting.

An anticipatory driving style helps the driver use the coasting function often and enhances the consumption-reducing effect of coasting.

If you can travel a certain distance without any foreseeable need to brake, it is beneficial to coast.

Coasting is suitable in the following driving situations, for example:

- ▶ Coasting on a straight downhill gradient with no obstacles.
- ▶ Coasting on a distance without obstacles.

To coast efficiently, avoid late or heavy braking.

Coasting is automatically adapted to the respective driving situation.

Depending on their equipment, vehicles that have mild hybrid technology do not display the engine speed on the tachometer when coasting.

Depending on vehicle equipment, "coasting" is displayed in the Live Vehicle menu as "Efficient coasting".

Additional information:

Current driving condition, refer to page [149](#).

### Functional requirements

To coast, the following functional requirements must be met:

- ▶ Selector lever position D is engaged.
- ▶ The brake has not been applied.
- ▶ The accelerator pedal is not being pressed.
- ▶ SPORT driving mode is not activated.
- ▶ Depending on national-market version: PERSONAL drive mode is not activated.
- ▶ Dynamic Stability Control is activated.

The function is available in the speed range from approx. 16 mph/25 km/h to 100 mph/160 km/h.

## Operation via shift paddles

### Principle

Depending on the vehicle's equipment, the Coasting mode can be influenced with the shift paddles.

### Activating/deactivating coasting via shift paddles

To activate coasting mode, pull the right shift paddle and hold it briefly.

To deactivate coasting mode, pull the left shift paddle.

### System limits

Coasting cannot be used, or can only be used to a limited extent, in the following situations:

- ▶ When Active Cruise Control is on.
- ▶ If driver assistance system sensors are defective, dirty, or covered.

## Efficient Mode

### Principle

Efficient Mode is a drive mode that provides consumption-optimized tuning and an anticipatory display.

In addition, the efficiency trainer displays situation dependent notes to assist with an efficient driving style.

The extended range achieved is displayed on the instrument cluster as a bonus range.

## Overview

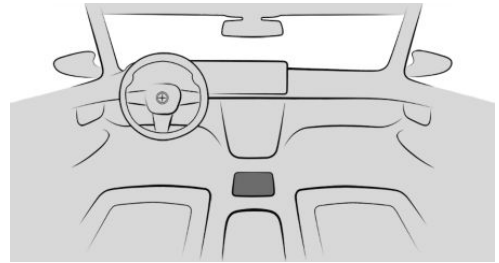

**MY MODES** The My Modes button located on the center console.

## Selecting the driving mode

1. **MY MODES** To select Efficient Range, press the My Modes button on the center console.
2. "EFFICIENT"

## Configuring Efficient mode

1. **MY MODES** To configure Efficient Range, press the My Modes button on the center console.
2. "EFFICIENT"
3. ⚙ Select the settings icon.
4. Select the desired setting.

## Resetting the settings

1. **MY MODES** To reset the settings for Efficient Mode, press the My Modes button on the center console.
2. "EFFICIENT"
3. ⚙ Select the settings icon.
4. "Reset settings"

## Efficiency trainer

### Principle

The Efficiency Coach supports an anticipatory and comfort-oriented driving style. The Efficiency Coach uses map and sensor data to analyze the current driving situation, e.g., upcoming speed limits and preceding vehicles. Based on this information, the driver is promptly instructed to drive in a manner that reduces their consumption. On the control display, the driving style is assessed with regard to fuel consumption and shown in three categories.

This system provides various indicators that help the driver to reduce their consumption.

### Functional requirements

To use the Efficiency Coach, the following functional requirements must be met:

- ▶ Selector lever position D is engaged.
- ▶ Efficient Mode is activated.

### Display

#### Power gauge

When Efficient Mode is activated, the instrument cluster displays a special view.

Depending on the equipment, some system information can also be displayed in the Head-up display.

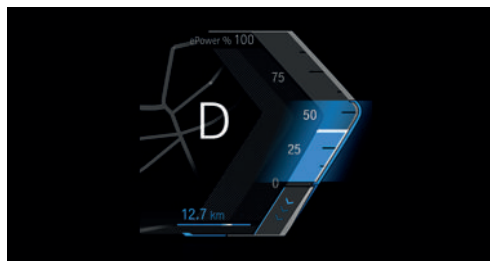

A blue range appears on the power gauge, indicating reduced consumption while driving.

The size of this blue range depends on the driving situation.

Additionally, the bonus range will be displayed.

If the power gauge moves within this blue range, the vehicle is being driven with reduced consumption.

If the blue range turns gray, the fuel consumption has increased.

#### Bonus range

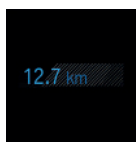

A modified driving style helps you extend your driving range.

The range extension is displayed as the bonus range in the instrument cluster.

If the bonus range turns gray or disappears, the vehicle is not currently being driven with reduced consumption.

The indicator turns blue once all requirements for driving with reduced consumption have been met.

The intervals for resetting the bonus range depend on the settings of the trip data.

#### Indicator for increased consumption



If the vehicle is not being driven in a manner that reduces its consumption, an arrow appears on the instrument cluster.

This is displayed in the following situations, for example:

- ▶ Excessive acceleration.
- ▶ Excessive speed.

In addition, information on the reason for the delay can be displayed.

#### System limits

This function may not be available in the following situations, for example:

- ▶ When Active Cruise Control is on.
- ▶ When the transmission Sport program is activated.

## Anticipatory driving style

### Principle

An indicator on the instrument cluster informs the driver when deceleration will be necessary soon, even if the cause is not yet visible. Situations requiring vehicle deceleration include, for example: roundabouts or lower speed limits.

Situation-specific information and the distance to the upcoming route section is shown above the current speed limit on the instrument cluster.

If an alert is received, the vehicle's speed and its consumption can be reduced using the appropriate accelerator pedal position and coasting until the route section is reached.

This system recommends that the driver promptly slow down by shrinking the blue range on the power gauge on the instrument cluster. The blue range on the power gauge remains small until the route segment is reached.





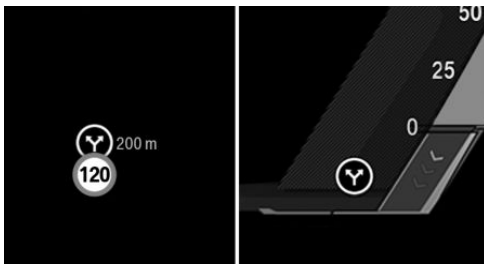

### Display in the instrument cluster

The forecast information is displayed on the instrument cluster.



The prompt for an upcoming route segment, for example, is issued as a recommendation to let the vehicle coast.

The icon, e.g., to turn, indicates the route section detected.

Icon	Meaning
	Turn.
	Speed limit or entering an urban area.
	Roundabout.
	Exit on roads outside of towns and cities.
	Curve.
	A vehicle has been detected ahead of you.

### System limits

The display of the upcoming route sections is not available in the following situations, for instance:

- ▶ The speed limits are temporary and variable, e.g., in construction zones.
- ▶ In the case of navigation data that is invalid, outdated or not available.
- ▶ With country-specific restrictions on map-based route sections.

## Driving style assessment

### Principle

The Efficiency Coach evaluates the driving style for the current trip with regard to fuel consumption.

The following categories are shown via bar display on the control display:

- ▷ Anticipatory driving style.
- ▷ Acceleration behavior.
- ▷ Speed.

The more the driving style reduces consumption, the longer the bars shown will be.

## Functional requirements

The driving style assessment can be used in Efficient Mode.

## Bringing up the driving style assessment

To bring up the driving style assessment, go through the menu as follows: Apps menu / "Vehicle" / "Live Vehicle".



# Refueling

## Vehicle features and options

This chapter describes model-specific equipment, systems, and functions that are currently available, or may become available in the future, even if they are not present in the vehicle.

Additional information:

Vehicle equipment, refer to page [8](#).

## Follow the following when refueling

### General information

Before refueling, note the recommended fuel.

When refueling, hook the fuel pump nozzle completely into the filler pipe. Lifting the pump nozzle while refilling causes the diesel exhaust fluid to shut off prematurely and reduces fuel vapor recirculation.

The fuel tank is full when the fuel pump nozzle clicks off the first time.

Make sure that the fuel cap is closed properly after refueling, otherwise the emissions warning light may illuminate.

Follow safety regulations posted at the filling station.

Additional information:

Fuel quality, refer to page [350](#).

## Safety information

### NOTICE

With a range below 30 miles/50 km, the engine may no longer have sufficient fuel. Engine functions are not ensured anymore. There is a risk of property damage. Refuel promptly.

### NOTICE

Fuels are toxic and aggressive. Overfilling of the fuel tank can damage the fuel system. Painted surfaces may be damaged by contact with fuel. Escaping fuel can harm the environment. There is a risk of property damage. Avoid overfilling.

## Fuel filler cap

### General information

If the fuel filler cap is not fitted correctly, the emissions indicator light illuminates on the instrument cluster.

Additional information:

Indicator/warning lights, refer to page [135](#).

## Safety information

### WARNING

The fuel filler cap's retaining strap can become pinched and crushed when the cap is closed. It will then not be possible to close the fuel filler cap correctly. Fuel or fuel vapors can escape. There is a risk of injury and risk of property damage. Make sure that the

retaining strap does not become pinched or crushed when closing the fuel filler cap.

## Opening the fuel filler cap

1. To open the fuel filler flap, press on the rear edge. The fuel filler flap opens.

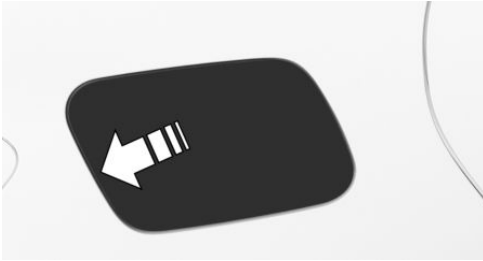

2. Turn the fuel filler cap counterclockwise.

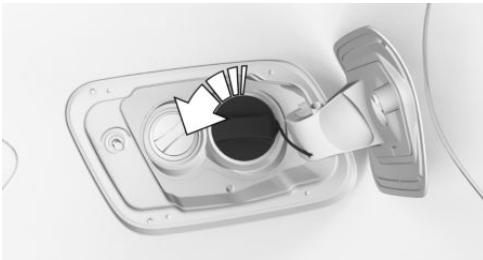

3. Place the fuel filler cap in the mount on the fuel filler flap.

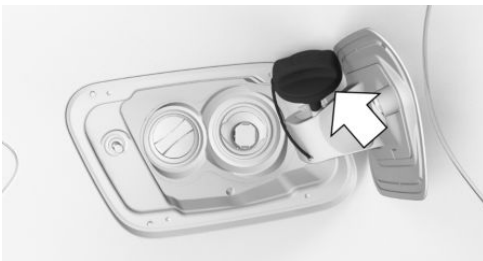

## Closing the fuel filler cap

To open the fuel filler cap, proceed as follows:

1. Fit the fuel filler cap and turn it clockwise until it clicks audibly.
2. Press the fuel filler flap in until it engages.

## Emergency unlocking

In certain situations, it may be necessary to unlock the fuel filler flap manually, e.g., an electrical malfunction.

In this case, have the fuel filler flap unlocked by an authorized service center or another qualified service center or repair shop.

# Wheels and tires

## Vehicle features and options

This chapter describes model-specific equipment, systems, and functions that are currently available, or may become available in the future, even if they are not present in the vehicle.

Additional information:

Vehicle equipment, refer to page 8.

## Tire pressure

### General information

The tire condition and tire pressure influence the following:

- ▷ Tire service life.
- ▷ Driving safety.
- ▷ Driving comfort.
- ▷ Fuel consumption.

### Safety information

#### **WARNING**

A tire with too little or no tire inflation pressure may heat up significantly and sustain damage. This will have a negative impact on aspects of handling such as steering and braking response. There is a risk of accident, injury, and property damage. Regularly check the tire pressure, and correct it as needed, for instance twice a month and before a long trip.

## Tire pressure specifications

### In the tire pressure table

The tire pressure table contains all tire inflation pressure specifications for given tire sizes

at ambient temperature. The tire inflation pressure specifications apply to the tire sizes approved by the vehicle manufacturer for the corresponding vehicle types.

To identify the correct tire pressure, please note the following:

- ▷ Tire sizes of the vehicle.
- ▷ Maximum speed for driving.

### On the control display

The current tire inflation pressure values and the intended tire inflation pressure values for the mounted tires can be displayed on the control display.

To ensure that they are displayed correctly, the tire sizes must be stored in the system and must have been set for the mounted tires.

The current tire inflation pressure value is located on each tire.

The reference tire inflation pressure value is located in the lower area of the control display.

## Checking the tire pressure

### General information

The tires heat up while driving. The tire pressure increases with the tire temperature.

Check the tire pressure regularly and correct as necessary.

Tires have a natural, consistent tire pressure loss. The displays of inflation devices may under-read by up to 0.1 bar/2 psi.

### Functional requirements

Only check the tire pressure when the tires are cold, i.e.:

- ▶ A distance traveled of max. 1.25 miles/2 km has not been exceeded.
- ▶ If the vehicle has not moved again for at least two hours after a trip.

### In the tire pressure table

To check the tire pressure using the tire pressure specifications in the tire pressure table, proceed as follows:

1. Determine the nominal tire pressure for the vehicle's tires by referring to the information on the driver's door pillar.
2. Check the tire pressure in all four tires, e.g., using a pressure gage.
3. Correct the tire pressure if the current tire pressure deviates from the target tire pressure.
4. Make sure that all valve caps are screwed onto the tire valves.

The tire pressure specifications in the tire pressure table correspond only to cold tires or to tires at the same temperature as the ambient temperature.

If vehicle is equipped with an emergency wheel: Check the tire pressure of the emergency wheel in the cargo area regularly and correct as necessary.

### Tire inflation pressures up to 100 mph/160 km/h

For speeds of up to 100 mph/160 km/h and for optimum driving comfort, follow the tire inflation pressure specifications in the tire pressure table and adjust as necessary.

### On the control display

To check the tire pressure using the tire pressure information on the control display, proceed as follows:

1. Go through the menu as follows: Apps menu / "Vehicle" / "Vehicle status" / "Tire Pressure Monitor".
2. Check whether the current tire inflation pressure levels deviate from the intended tire pressure value.
3. Correct the tire pressure if the current tire pressure deviates from the target tire pressure.

The display of current tire pressure on the control display may be restricted when the vehicle is stationary. The tire pressure will update after a short drive.

### After correcting the tire pressure

If your vehicle is equipped with a Tire Pressure Monitor, the corrected tire pressures are applied automatically. Make sure that the tire settings are correct. When using tires not found in the tire inflation pressure specifications on the control display, reset the Tire Pressure Monitor.

If your vehicle is equipped with the flat tire monitor, reinitialize it.



The tire inflation pressure specifications can also be found on the tire pressure label on the driver's door pillar.

Do not exceed a speed of 100 mph/160 km/h.

## Tire pressure values up to 100 mph/160 km/h 228, 228 xDrive

The tire inflation pressure specifications in the tire pressure table correspond to cold tires and full load.

Tire size	Front wheel Tire pressure specifications in bar/PSI	Rear wheel Tire pressure specifications in bar/PSI
225/45 R 18 95 H XL A/S	2.5 / 36	2.4 / 35
225/45 R 18 95 Y XL		
225/45 R 18 95 V XL M+S		
225/40 R 19 93 Y XL	2.7 / 39	2.6 / 38
225/40 R 19 93 H XL M+S		
HL 195/50 R 18 93 H XL M+S	2.7 / 39	2.7 / 39
HL 195/45 R 19 91 H XL M+S	2.9 / 42	2.8 / 41
Emergency wheel: T 125/80 R 17 99 M	Speed up to a max. of 50 mph / 80 km/h 4.2 / 60	

## M235 xDrive

The tire inflation pressure specifications in the tire pressure table correspond to cold tires and full load.

Tire size	Front wheel Tire pressure specifications in bar/PSI	Rear wheel Tire pressure specifications in bar/PSI
225/45 R 18 95 H XL A/S	2.5 / 36	2.5 / 36
235/40 R 19 96 Y XL		
235/40 ZR 19 96 Y XL		
225/45 R 18 95 Y XL		
225/45 R 18 95 V XL M+S	2.5 / 36	2.5 / 36
225/40 R 19 93 H XL M+S	2.7 / 39	2.7 / 39
HL 195/50 R 18 93 H XL M+S	2.8 / 41	2.7 / 39
HL 195/45 R 19 91 H XL M+S	2.9 / 42	2.9 / 42

## Tire pressures over 100 mph/160 km/h

### **WARNING**

When driving at speeds greater than 100 mph/160 km/h, incorrect tire pressures can negatively affect vehicle handling, e.g., safety or comfort while driving. The tires can become damaged, which may cause an ac-

cident. There is a risk of accident, injury, and property damage. To drive at maximum speeds, note the specified tire pressure for driving above 100 mph/160 km/h in the tire inflation pressure table, and adjust as necessary.

## Tire pressure values over 100 mph/160 km/h 228, 228 xDrive

The tire inflation pressure specifications in the tire pressure table correspond to cold tires and full load.

Tire size	Front wheel Tire pressure specifications in bar/PSI	Rear wheel Tire pressure specifications in bar/PSI
225/45 R 18 95 H XL A/S 225/45 R 18 95 Y XL	2.8 / 41	2.7 / 39
225/45 R 18 95 V XL M+S 225/40 R 19 93 Y XL 225/40 R 19 93 H XL M+S	3.1 / 45	3.0 / 44
HL 195/50 R 18 93 H XL M+S	3.0 / 44	2.9 / 42
HL 195/45 R 19 91 H XL M+S	3.2 / 46	3.1 / 45
Emergency wheel: T 125/80 R 17 99 M	Speed up to a max. of 50 mph / 80 km/h 4.2 / 60	

## M235 xDrive

The tire inflation pressure specifications in the tire pressure table correspond to cold tires and full load.

Tire size	Front wheel Tire pressure specifications in bar/PSI	Rear wheel Tire pressure specifications in bar/PSI
225/45 R 18 95 H XL A/S 235/40 R 19 96 Y XL 235/40 ZR 19 96 Y XL	2.8 / 41	2.7 / 39
225/45 R 18 95 Y XL	2.9 / 42	2.8 / 41
225/45 R 18 95 V XL M+S 225/40 R 19 93 H XL M+S HL 195/50 R 18 93 H XL M+S	3.1 / 45	3.0 / 44
HL 195/45 R 19 91 H XL M+S	3.2 / 46	3.2 / 46

## Tire marking

### Tire size

245/45 R 18 96 Y

245: nominal width in mm

45: Tire aspect ratio in %

R: radial tire code

18: rim diameter in inches

96: load index

Y: speed code letter

ZR tires: reinforced radial tires for speeds exceeding 150 mph/240 km/h

### Maximum tire load

Maximum tire load is the maximum permissible weight for which the tire is approved.

Locate the maximum tire load on the tire sidewall and the Gross Axle Weight Rating – GAWR – on the certification label on the driver door B-pillar. Divide the tire load by 1.1. It must be greater than one-half of the vehicle's Gross Axle Weight Rating – GAWR. Note, front vs. rear GAWR and tire loads, respectively.

## Speed letter

Designation	Maximum speed
Q	up to 100 mph/160 km/h
R	up to 106 mph/170 km/h
S	up to 112 mph/180 km/h
T	up to 118 mph/190 km/h
H	up to 131 mph/210 km/h
V	up to 150 mph/240 km/h
W	up to 167 mph/270 km/h
Y	up to 186 mph/300 km/h
(Y)	above 186 mph/300 km/h

## Tire Identification Number

DOT code: DOT xxxx xxx 1925

xxxx: manufacturer code for the tire brand

xxx: tire size and tire design

1925: tire age

Tires with DOT codes meet the guidelines of the U.S. Department of Transportation.

## Tire age

### Recommendation

Regardless of the tire tread depth, replace tires at least every 6 years.

### Production date

The tire's production date is found on the tire sidewall.

Designation	Production date
DOT ... 1925	19th week of 2025

## Uniform Tire Quality Grading

Quality grades can be found where applicable on the tire sidewall between tread shoulder and maximum section width.

For example: Treadwear 200; Traction AA; Temperature A

## DOT Quality Grades

Treadwear

Traction AA A B C

Temperature A B C

All passenger car tires must conform to Federal Safety Requirements in addition to these grades.

## Treadwear

The treadwear grade is a comparative rating based on the wear rate of the tire when tested under controlled conditions on a specified government test course. For example, a tire graded 150 would wear one and one-half, 1 g, times as well on the government course as a tire graded 100. The relative performance of tires depends upon the actual conditions of their use, however, and may depart significantly from the norm due to variations in driving habits, service practices and differences in road characteristics and climate.

## Traction

The traction grades, from highest to lowest, are AA, A, B, and C.

Those grades represent the tire's ability to stop on wet pavement as measured under controlled conditions on specified government test surfaces of asphalt and concrete. A tire marked C may have poor traction performance.

The traction grade assigned to this tire is based on straight-ahead braking traction tests, and does not include acceleration, cornering, hydroplaning, or peak traction characteristics.

## Temperature

The temperature grades are A, the highest, B, and C, representing the tire's resistance to the generation of heat and its ability to dissipate heat when tested under controlled conditions on a specified indoor laboratory test wheel. Sustained high temperature can cause the material of the tire to degenerate and reduce tire life, and excessive temperature can lead to sudden tire failure. The grade C corresponds to a level of performance which all passenger car tires must meet under the Federal Motor Vehicle Safety Standard No. 109. Grades Band A represent higher levels of performance on the laboratory test wheel than the minimum required by law.

### WARNING

The temperature grade for this tire is established for a tire that is properly inflated and not overloaded. Excessive speed, underinflation, or excessive loading, either separately or in combination, can cause heat buildup and possible tire failure. There is a risk of accident, injury and a risk of damage to property.

## Runflat tires

Run-flat tires, refer to page 325, are indicated by a circular icon containing the letters "RSC" on the tire sidewall.

## M+S

Winter tires, as well as all-season tires with better winter performance than summer tires, are indicated by the letters "M+S" on the tire sidewall.

## Tire tread depth

### Safety information

#### WARNING

If the tire tread depth is too low, driving safety may be impaired in critical situations. There is a risk of accident, injury, and property damage. Follow applicable legal requirements for minimum tread depth.

## Minimum tread depth

Generally speaking, the legal minimum tread depths may differ for summer tires, winter tires, and all-season tires. To ensure optimum handling, e.g., in wet or snowy conditions, it may be useful to change a tire before it reaches the legal minimum tread depth. For more information, contact an authorized service center or another qualified service center or repair shop.

## Wear indicators



The tire manufacturer's wear indicators are distributed around the tire circumference and have a height of at least 0.06 in/1.6 mm.

The wear indicators serve as indicators for the wear of the tire tread.

The locations of the wear indicators are indicated by the letters "TWI" (tread wear indicator) on the tire sidewall.

## Tire damage

### General information

Check your tires regularly for damage, foreign objects lodged in the tread, and tread wear.

The following abnormalities may indicate tire damage or a malfunction on the vehicle:

- ▶ Unusual vibrations.
- ▶ Unusual tire or running noises.
- ▶ Unusual vehicle handling such as a strong tendency to pull to the left or right.
- ▶ Uneven wear pattern such as increased wear near tire shoulder.

Tire damage can be caused by situations such as the following:

- ▶ Driving over curbs.
- ▶ Road damage.
- ▶ Tire pressure too low.
- ▶ Vehicle overloading.
- ▶ Incorrect tire storage.

## Safety information

### **WARNING**

Damaged tires can lose tire pressure, which can lead to loss of vehicle control. There is a risk of accident, injury, and property damage. If tire damage is suspected while driving, immediately reduce speed and stop. Have wheels and tires checked. Drive carefully to an authorized service center or another qualified service center or repair shop. Have the vehicle towed or transported as needed. Do not repair damaged tires, but have them replaced.

### **WARNING**

The wheels, tires and chassis components can become damaged when driving over curbs, road damage, or other obstacles. Larger wheels have a smaller tire cross-section. The smaller the tire cross-section, the higher the risk of tire damage. There is a risk of accident, injury, and property damage. If possible, avoid driving over curbs, road damage or other obstacles, or drive over them slowly and carefully.

## Exchanging wheels and tires

### Mounting and wheel balancing

Have the wheel mounted and balanced by an authorized service center or another qualified service center or repair shop.

### Suitable wheels and tires

#### General information

Only certain wheel/tire combinations are suitable, depending on vehicle and equipment. The

vehicle manufacturer determines wheel/tire combinations based on the following criteria:

- ▷ Tire size, e.g., tire width, aspect ratio.
- ▷ Wheel size, e.g., rim diameter, offset.

For more information on wheel/tire combinations and special equipment, contact an authorized service center or another qualified service center or repair shop.

## Safety information

### **WARNING**

Wheels and tires that are not suitable for the vehicle can damage parts of the vehicle. There is a risk of accident, injury, and property damage. The vehicle manufacturer recommends that you use only wheels and tires that have been recommended for the vehicle type.

### **Warning**

Wheel/tire combinations that are not suitable for the vehicle can affect vehicle handling and a number of system functions, e.g., the Antilock Braking System or Dynamic Stability Control. There is a risk of accident, injury, and property damage. The manufacturer of the vehicle recommends that you use wheels and tires that have been recommended by the vehicle manufacturer for the vehicle type. Following tire damage, have the original wheel/tire combination remounted on the vehicle as soon as possible.

## Recommended tire brands



Tire types are developed for each vehicle and optimized specifically for the individual requirements of that vehicle, e.g.:

- ▷ Handling.
- ▷ Comfort.
- ▷ Noise characteristics.

Specially developed tires are indicated by a star on the tire sidewall. After replacing wheels and tires, the vehicle manufacturer recommends using star-marked tires again. The vehicle manufacturer recommends using tires of the same make and tire tread.

## New tires

Tire traction is not optimal due to manufacturing circumstances when tires are brand new.

Drive conservatively for the first 200 miles/300 km.

## Retreaded tires

### WARNING

Retreaded tires can have different tire casing structures. With advanced age the service life may be limited. There is a risk of accident, injury, and property damage. The manufacturer of the vehicle does not recommend the use of retreaded tires.

## Maximum speed

### Safety information

#### WARNING

If the maximum permissible speed of your mounted tires is exceeded, the tires may be damaged. There is a risk of accident, injury, and property damage. Do not exceed the maximum permissible speed of the tires.

## Maximum speed of winter tires

If the vehicle's maximum speed is higher than the maximum permissible speed of the winter tires, place a sign indicating the maximum permissible speed in the driver's field of vision. The info label is available from an authorized service center or another qualified service center or repair shop.

## Winter tires



Winter tires are recommended for operating on winter roads.

Winter tires are indicated by the mountain/snowflake icon and the letters "M+S" on the tire sidewall.

So-called all-season tires with the M+S designation but no mountain/snowflake icon perform better in winter than summer tires. As a rule, all-season tires do not perform the same as winter tires.

## Changing run-flat tires

When changing from run-flat tires to standard tires, it must be ensured that the vehicle contains an emergency wheel or tire mobility kit. For more information, contact an authorized service center or another qualified service center or repair shop.

## Wheel change between axles

Different tread wear patterns can occur on the front and rear axles depending on individual driving conditions. The tires can be rotated in pairs between the axles to achieve even abrasion. For more information, contact an authorized service center or another qualified service center or repair shop. After changing a wheel, check the tire pressure and correct as necessary.

## Storing tires

When storing tires, do not exceed the maximum tire pressure specified on the tire sidewall.

When storing tires, note the following:

- ▶ Store wheels and tires in a cool, dry and dark place.
- ▶ Protect tires from coming into contact with oil, grease, and solvents.
- ▶ Do not leave the tires in plastic bags.
- ▶ Remove dirt from wheels or tires.

## Runflat tires

### Principle

Runflat tires permit continued driving under limited conditions even in the event of a complete tire pressure loss.

### General information

The wheels consist of tires that are self-supporting to a limited degree and may also include special rims.

The reinforced tire sidewall makes it possible to continue driving to a limited extent if a tire loses pressure.

Follow the instructions for continuing to drive with a flat tire.

## Safety information

### WARNING

The vehicle handles differently when a runflat tire has insufficient or no tire pressure; for instance, reduced directional stability when braking, braking distances are longer and the self-steering properties will change. There is a risk of accident, injury, and property damage. Drive moderately and do not exceed a speed of 50 mph/80 km/h.

### WARNING

Vibrations or loud noises while driving can indicate the final failure of a tire. Tire components may come loose. There is a risk of accident, injury, and property damage. Reduce your speed and stop. Do not continue driving. Contact an authorized service center or another qualified service center or repair shop.

## Identification



Run-flat tires are indicated by a circular icon containing the letters "RSC" on the tire sidewall.

## Track tires

### General information

The vehicle can be fitted with sport tires, which have been optimized for use on a racetrack in dry conditions.

These track tires are made from an optimized material mixture specially derived from motorsport. In addition, the tire tread is partly reduced to create a larger contact area with the road surface. These adjustments can increase driving dynamics such as steering behavior, precision, or road grip.

Additional information:

- ▶ At an authorized service center or another qualified service center or repair shop.
- ▶ On the website of the respective tire manufacturer.

### Safety information

#### WARNING

Track tires can become damaged, e.g., torn and broken, at temperatures below 32°F/0°C. There is a risk of accident, injury, and property damage. Do not move, mount, or drive on track tires at temperatures below 32°F/0°C.

#### WARNING

When driving with track tires on wet roads or racetracks, driving safety may be jeopardized in critical situations, e.g., aquaplaning. There is a risk of accident, injury, and property damage. Drive at a suitable speed and with driving stability control systems enabled, e.g., Dynamic Stability Control.

#### WARNING

When driving with track tires, driving safety may be jeopardized, e.g., sudden loss of adhesion, at temperatures below 59°F/15°C. There is a risk of accident, injury, and property damage. At temperatures below 59°F/15°C, drive at a suitable speed and with driving stability control systems enabled, e.g., Dynamic Stability Control.

### Storage

If track tires are not used for some time, we recommend removing the wheels from the vehicle.

Store removed wheels or track tires in a clean, dry, and dark place at temperatures above 32°F/0°C.

### Use on the road

The track tires meet the legal requirements for use on public roads.

After being used on a racetrack, the track tires may no longer be suitable for road use. Therefore, after using them on a racetrack, check the track tires with respect to legal requirements for use on public roads, e.g., minimum tread depth.

### Use on a racetrack

#### General information

Always check the track tires for damage, foreign objects lodged in the tread, and wear before using them on a racetrack.

Check the tire pressures when the tires are cold.

Bring the track tires to temperature with a moderate, modified driving style when using them on the racetrack.

## Intensive use

Track tires may become damaged after being used for rigorous racetrack driving for some time, being driven over curbs, or being driven off-road.

Check track tires for damage, foreign objects lodged in the tread, and wear. The wheel must be removed in order to check the outside and inside of the track tires. Have track tires checked by an authorized service center or another qualified service center or repair shop.

## Tire pressure

### General information

Check the tire inflation pressure regularly and correct it if necessary, taking the regulations for use on the road or a racetrack into account. The tires heat up while driving. The tire pressure increases with the tire temperature.

### Tire pressure specifications

The tire pressure table contains all tire inflation pressure specifications for given tire sizes at ambient temperature. The tire inflation pressure specifications apply to the tire sizes approved by the vehicle manufacturer for the corresponding model variants.

To identify the correct tire pressure, please note the following:

- ▶ Tire sizes of the vehicle.
- ▶ Maximum speed at which the vehicle is driven.

## Snow chains

### Safety information

#### **WARNING**

Mounting snow chains on unsuitable tires can cause the snow chains to come into contact with vehicle parts. There is a risk of accident, injury, and property damage. Only fit snow chains on tires recommended by the vehicle manufacturer for use with snow chains.

#### **WARNING**

Insufficiently tight snow chains may damage tires and vehicle components. There is a risk of accident, injury, and property damage. Make sure that the snow chains are always sufficiently tight. Re-tighten as needed according to the snow chain manufacturer's instructions.

### Fine-link snow chains

The manufacturer of the vehicle recommends the use of fine-link snow chains.

For information on suitable snow chains, contact an authorized service center or another qualified service center or repair shop.

### Use

Snow chains can only be used in pairs on front wheels of the following wheel/tire sizes:

Tire size	Wheel size	Rim offset (IS)
HL 195/50 R18	6.5J x 18	42
HL 195/45 R19	6.5J x 19	42

Information on the wheel size and rim offset is located on the inside of the wheel.

The list can also include wheel/tire sizes that are only suitable for certain models.

Information on wheels and tires approved for the vehicle can be requested from an authorized service center or another qualified service center or repair shop.

Follow the instructions of the snow chain manufacturer.

If your vehicle is equipped with a Tire Pressure Monitor, note the following: do not reset the Tire Pressure Monitor when using snow chains, otherwise incorrect values may be displayed.

If your vehicle is equipped with a Flat Tire Monitor, note the following: do not initialize the Flat Tire Monitor when using snow chains, otherwise incorrect values may be displayed.

When using with snow chains, activate drive-off support to optimize the drive power as necessary.

## Maximum speed with snow chains

When using snow chains, do not exceed a maximum speed of 30 mph/50 km/h.

## Tire Pressure Monitor

### Principle

The Tire Pressure Monitor monitors the tire pressure and issues a warning if the tire pressure has dropped.

The sensors in the tire valves measure the tire pressure and tire temperature.

Depending on the tires detected or registered, the system displays the specified nominal pressures on the control display and compares them with the current tire pressures.

### General information

When using tires not found in the tire inflation pressure specifications on the vehicle, such as tires with special approval, the Tire Pressure

Monitor must be actively reset. The system will then take over the current tire pressures as the target pressures.

When operating the system, also note the information found in the Tire inflation pressure chapter.

Additional information:

Tire inflation pressure, refer to page [316](#).

## Safety information

### WARNING

The display of the target pressures is not a substitute for the tire inflation pressure details on the vehicle. Incorrect entries in the tire settings can lead to incorrect target tire inflation pressure values. In this case, it cannot be guaranteed that the notification of a tire pressure loss will be reliable. There is a risk of injury and risk of property damage. Make sure that the sizes of your mounted tires are displayed correctly and match the information on the tires and the tire inflation pressure specifications on the vehicle.

## Functional requirements

To use the Tire Pressure Monitor, the following functional requirements must be met:

- ▶ After each tire or wheel change, the system detects and updates the mounted tires on the control display and displays them after a short trip.
- ▶ The Tire Pressure Monitor does not activate until after driving for a few minutes:
  - ▶ After a tire or wheel change.
  - ▶ After a reset, when using tires with special approval.
  - ▶ After changing tire settings.

- ▷ In the case of tires with special approval, a reset was performed after a tire or wheel change or after adjusting the tire pressure.
- ▷ Wheels with tire pressure sensors are mounted.

## Tire settings

### General information

You can enter information on your mounted tires in the tire settings if the tires are not automatically detected by the system.

The tire sizes of the mounted tires can be gathered from the tire inflation pressure details on the vehicle or directly on the tires.

The tire details do not need to be re-entered when the tire pressure is corrected.

For summer and winter tires, the tire details entered last are stored. After a tire or wheel change, the settings of the tire sets used last can be selected.

### Configuring the tire settings

1. To enter information on the tires mounted in the tire settings, go through the menu as follows: Apps menu / "Vehicle" / "Vehicle status" / "Tire Pressure Monitor" / "Tire settings" / "Tire selection" / "Manual" / "Tire type".
2. Select the tire size for the rear axle.  
When using tires with special approval: "Other tires".
3. Select the maximum speed to be driven.
4. "Save tire settings"

The measurement of the current tire inflation pressure is started. The measurement progress is displayed.

## Status display

### Current status

The status of the Tire Pressure Monitor, e.g., whether this system is active, can be shown on the control display.

Go through the menu as follows: Apps menu / "Vehicle" / "Vehicle status" / "Tire Pressure Monitor".

The current status is displayed.

### Current tire pressure

The current tire pressure is displayed for each tire.

The current tire inflation pressures may change while driving or depending on the outside temperature.

### Current tire temperature

The current tire temperatures are displayed depending on the model.

The current tire temperatures may change while driving or due to the outside temperature.

### Nominal pressure

The nominal pressure for the tires on the front and rear axles is displayed.

The specified nominal pressures take the influence of driving and outside temperature on the tire temperature into account. The appropriate nominal pressure is always displayed, independent of the weather situation, tire temperatures and travel times.

The displayed nominal pressure may change and may differ from the tire inflation pressure details on the door pillar of the driver's door. The tire inflation pressure can thus be corrected to the value of the displayed target pressures.

The nominal pressure is immediately adjusted if the vehicle load state is changed in the tire settings.

## Tire conditions

### General information

The tire and system condition are indicated by the color of the wheels and a text message in the Tire Pressure Monitor on the control display.

Any existing messages may not be deleted if the nominal pressure is not reached after the tire inflation pressure is corrected.

### All wheels green

When the system is active, all wheels illuminate green.

- ▶ This system bases any warnings on target pressures.
- ▶ When using tires with special approval, this system bases any warnings on the last tire pressures saved at the reset.

### One to four yellow wheels

The corresponding wheels illuminate yellow if the tire is flat or a significant pressure loss has been detected for the tires shown.

### Gray wheels

If no pressure loss has been detected for the tires, the wheels illuminate gray.

Possible causes are:

- ▶ The system may not be operational.
- ▶ After confirming the tire settings, the tire pressure is measured automatically.
- ▶ When using tires with special approval: the system is being reset.

### For tires with special approval: performing a reset

1. To reset tires with special approval, go through the menu as follows: Apps menu / "Vehicle" / "Vehicle status" / "Tire Pressure Monitor".
2. Make sure that the tire settings are correct.

3. Turn on drive-ready state but do not drive off.
4. "Perform reset"
5. Drive off.

The wheels are shown in gray and the tire pressure is reset.

After a travel time of several minutes, the set tire inflation pressures are accepted as the predefined tire inflation pressures. The reset is completed automatically while driving.

Once the reset is complete, the wheels on the control display are shown in green. A message is displayed.

You may interrupt this trip at any time. When you continue driving the reset resumes automatically.

Additional information:

Tire settings, refer to page [329](#).

## Messages: for tires without special approval

### General information

When a flat tire is indicated, the Dynamic Stability Control may be turned on.

### Safety information

#### **WARNING**

A damaged regular tire with low or no tire inflation pressure impacts handling such as steering and braking response. Runflat tires can maintain limited stability. There is a risk of accident, injury, and property damage. Do not continue driving if the vehicle is equipped with normal tires. Follow the information on runflat tires and continued driving with these tires.

## If a tire inflation pressure check is required

### Message

If it is necessary to check the tire pressure, a message appears.

An icon with a Check Control message appears on the control display.

#### Icon Possible cause



Leak detected on the tire.

Inflation was not carried out according to specifications, for instance when the tire has not been sufficiently inflated or in the case of a natural steady tire pressure loss.

### Measure

Check the tire pressure and correct as needed.

## If the tire inflation pressure is too low

### Message

If the tire pressure is too low, a message appears.



A yellow warning light is illuminated in the instrument cluster.

In addition, an icon with a Check Control message appears on the control display.

#### Icon Possible cause



There is a tire pressure loss.

### Measure

1. Reduce the vehicle speed. Do not continue to exceed a speed of 80 mph/130 km/h.
2. At the next opportunity, for instance at a filling station, check the tire inflation pressure in all four tires and correct if necessary.

## If there is a significant tire pressure loss

### Message

If the tire pressure drops significantly, a message appears.



A yellow warning light is illuminated in the instrument cluster.

In addition, an icon with the affected tire appears in a Check Control message on the control display.

#### Icon Possible cause



There is a flat tire or a major tire pressure loss.

### Measure

1. Reduce your speed and come to a stop carefully. Avoid sudden braking and steering maneuvers.
2. Check whether the vehicle is fitted with standard tires or run-flat tires.  
Run-flat tires are indicated by a circular icon containing the letters "RSC" on the tire sidewall.
3. Follow the instructions for what to do in case of a flat tire.

Additional information:

Actions in the event of a flat tire, refer to page [333](#).

## Messages: for tires with special approval

### General information

When a flat tire is indicated, the Dynamic Stability Control may be turned on.

## Safety information

### **WARNING**

A damaged regular tire with low or no tire inflation pressure impacts handling such as steering and braking response. Runflat tires can maintain limited stability. There is a risk of accident, injury, and property damage. Do not continue driving if the vehicle is equipped with normal tires. Follow the information on runflat tires and continued driving with these tires.

### If a tire inflation pressure check is required

#### Message

If it is necessary to check the tire pressure, a message appears.  
An icon with a Check Control message appears on the control display.

Icon	Possible cause
------	----------------



Inflation was not carried out according to specifications, e.g., the tire has not been sufficiently inflated.

The system has detected a wheel change, but no reset was done.

The tire inflation pressure has fallen below the level of the last reset.

No reset was performed for the system. The system issues a warning based on the tire inflation pressures stored during the last reset.

#### Measure

1. Check the tire pressure and correct as needed.
2. Perform a system reset.

## If the tire inflation pressure is too low

### Message

If the tire pressure is too low, a message appears.



A yellow warning light is illuminated in the instrument cluster.

In addition, an icon with a Check Control message appears on the control display.

Icon	Possible cause
------	----------------



There is a tire pressure loss.

No reset was performed for the system. The system issues a warning based on the tire inflation pressures stored during the last reset.

### Measure

1. Reduce the vehicle speed. Do not continue to exceed a speed of 80 mph/130 km/h.
2. At the next opportunity, for instance at a filling station, check the tire inflation pressure in all four tires and correct if necessary.
3. Perform a system reset.

### If there is a significant tire pressure loss

#### Message

If the tire pressure drops significantly, a message appears.



A yellow warning light is illuminated in the instrument cluster.

In addition, an icon with the affected tire appears in a Check Control message on the control display.

**Icon Possible cause**

There is a flat tire or a major tire pressure loss.

No reset was performed for the system. The system issues a warning based on the tire inflation pressures stored during the last reset.

**Measure**

1. Reduce your speed and come to a stop carefully. Avoid sudden braking and steering maneuvers.
2. Check whether the vehicle is fitted with standard tires or run-flat tires.  
Run-flat tires are indicated by a circular icon containing the letters "RSC" on the tire sidewall.
3. Follow the instructions for what to do in case of a flat tire.

Additional information:

Actions in the event of a flat tire, refer to page [333](#).

**Actions in the event of a flat tire****Standard tires**

1. In the event of a flat tire, identify the damaged tire.
2. Check the tire pressure in all four tires, for instance using the tire pressure display of a flat tire kit.  
For tires with special approval: when the tire pressure in all four tires is correct, the Tire Pressure Monitor may not have been reset. Then perform the reset.  
If no tire damage can be identified, contact an authorized service center or another qualified service center or repair shop.
3. Repair the flat tire, e.g., using a tire repair set or by changing the wheel.

The use of sealant, e.g., from the tire repair set, may damage the wheel electronics. Have the electronics replaced at the next opportunity.

**Runflat tires****Safety information**** WARNING**

The vehicle handles differently when a runflat tire has insufficient or no tire pressure; for instance, reduced directional stability when braking, braking distances are longer and the self-steering properties will change. There is a risk of accident, injury, and property damage. Drive moderately and do not exceed a speed of 50 mph/80 km/h.

** WARNING**

Vibrations or loud noises while driving can indicate the final failure of a tire. Tire components may come loose. There is a risk of accident, injury, and property damage. Reduce your speed and stop. Do not continue driving. Contact an authorized service center or another qualified service center or repair shop.

**Maximum speed**

You may continue driving with a damaged tire at speeds up to 50 mph/80 km/h.

**Continued driving with a flat tire**

Follow the following when continuing to drive with a damaged tire:

1. Avoid sudden braking and steering maneuvers.
2. Do not exceed a speed of 50 mph/80 km/h.
3. Check the tire inflation pressure in all four tires at the next opportunity.

### Possible driving distance with a flat tire

The possible driving distance which may be safely traveled varies depending on how the vehicle is loaded and used, e.g., speed, road conditions, outside temperature. The distance traveled may be less but may also be more if an economical driving style is used.

If the vehicle is loaded with an average weight and used under favorable conditions, the possible distance traveled may be up to 50 miles/80 km.

### Vehicle handling with damaged tires

Vehicles driven with a damaged tire will handle differently, potentially leading to conditions such as the following:

- ▶ Greater likelihood of skidding of the vehicle.
- ▶ Longer braking distances.
- ▶ Changed self-steering properties.

Modify your driving style. Avoid abrupt steering or driving over obstacles, for instance curbs or potholes.

## System limits

### Temperature

The tire pressure depends on the tire's temperature.

Driving or exposure to the sun will increase the tire temperature, thus increasing the tire inflation pressure.

The tire inflation pressure is reduced when the tire temperature falls again.

These circumstances may cause a warning when temperatures fall very sharply.

Following a temperature-related warning, the target pressures are displayed on the control display again after a short distance.

### Sudden tire pressure loss

The system is not able to indicate sudden and serious tire damage and the resulting loss of

tire pressure caused by external circumstances.

### Failure performing a reset

For tires with special approval, this system will not function correctly if it has not been reset. For example, a flat tire is being reported despite the tires having the correct pressure.

## Malfunition

### Message

The Tire Pressure Monitor displays a message if the system is not operational.



The yellow warning light flashes and is then illuminated continuously. A Check Control message is displayed. It may not be possible to identify tire pressure losses.

### Measure

If the Tire Pressure Monitor system is not operational, proceed as follows:

- ▶ If a wheel without air pressure sensor is mounted, have the wheels checked as necessary.
- ▶ Fault due to systems or devices with same transmission frequency: The system reacts automatically upon leaving the interference zone.
- ▶ The system was unable to completely reset when using tires with special approval. Perform a system reset again.
- ▶ If the Tire Pressure Monitor has failed: Have the vehicle checked by an authorized service center or another qualified service center or repair shop.

### Declaration according to NHTSA/FMVSS 138 Tire Pressure Monitoring System

Each tire, including the spare (if provided) should be checked monthly when cold and inflated to the inflation pressure recommended

by the vehicle manufacturer on the vehicle placard or tire inflation pressure label. (If your vehicle has tires of a different size than the size indicated on the vehicle placard or tire inflation pressure label, you should determine the proper tire inflation pressure for those tires.) As an added safety feature, your vehicle has been equipped with a tire pressure monitoring system (TPMS) that illuminates a low tire pressure telltale when one or more of your tires is significantly under-inflated. Accordingly, when the low tire pressure telltale illuminates, you should stop and check your tires as soon as possible, and inflate them to the proper pressure. Driving on a significantly under-inflated tire causes the tire to overheat and can lead to tire failure. Under-inflation also reduces fuel efficiency and tire tread life, and may affect the vehicle's handling and stopping ability. Please note that the TPMS is not a substitute for proper tire maintenance, and it is the driver's responsibility to maintain correct tire pressure, even if under-inflation has not reached the level to trigger illumination of the TPMS low tire pressure telltale. Your vehicle has also been equipped with a TPMS malfunction indicator to indicate when the system is not operating properly. The TPMS malfunction indicator is combined with the low tire pressure telltale. When the system detects a malfunction, the telltale will flash for approximately one minute and then remain continuously illuminated. This sequence will continue upon subsequent vehicle start-ups as long as the malfunction exists. When the malfunction indicator is illuminated, the system may not be able to detect or signal low tire pressure as intended. TPMS malfunctions may occur for a variety of reasons, including the installation of replacement or alternate tires or wheels on the vehicle that prevent the TPMS from functioning properly. Always check the TPMS malfunction telltale after replacing one or more tires or wheels on your vehicle to ensure that the replacement or alternate tires and wheels allow the TPMS to continue to function properly.

## Flat tire monitor

### Principle

The flat tire monitor detects a tire pressure loss while driving and issues a warning if the tire pressure has dropped.

The system does not measure the actual inflation pressure in the tires.

The system detects tire pressure loss on the basis of rotation speed differences between the individual wheels while driving.

If a tire loses pressure, the diameter and thus the rotational speed of the corresponding wheel changes. The difference will be detected and reported as a flat tire.

### Functional requirements

To use the flat tire monitor, the following functional requirements must be met:

- ▶ After a tire or wheel change, an initialization was carried out at the correct tire pressure.
- ▶ After the tire pressure was adjusted to a new value, an initialization was performed.

### Status display

The current status of the flat tire monitor can be displayed on the control display, e.g., to check whether the flat tire monitor is active.

Go through the menu as follows: Apps menu / "Vehicle" / "Vehicle status" / "Flat tire monitor".

### Initialization required

The flat tire monitor must be initialized in the following situations:

- ▶ After the tire inflation pressure has been adjusted.
- ▶ After a tire or wheel change.

### Performing initialization

When initializing the flat tire monitor, the tire pressures you set serve as a reference value

for detecting a flat tire. Initialization is started by confirming the tire inflation pressures.

Do not initialize the system when driving with snow chains.

1. To initialize the flat tire monitor, go through the menu as follows: Apps menu / "Vehicle" / "Vehicle status" / "Flat tire monitor".
2. Switch on drive-ready state.
3. "Perform reset"
4. Drive off.

The initialization is completed while driving, which can be interrupted at any time.

The initialization automatically continues when driving continues.

## Messages

### Safety information

#### **WARNING**

A damaged regular tire with low or no tire inflation pressure impacts handling such as steering and braking response. Runflat tires can maintain limited stability. There is a risk of accident, injury, and property damage. Do not continue driving if the vehicle is equipped with normal tires. Follow the information on runflat tires and continued driving with these tires.

### Indication of a flat tire

A message appears if there is a flat tire.

When a flat tire is indicated, the Dynamic Stability Control (DSC) is turned on, if needed.



A yellow warning light is illuminated in the instrument cluster.

In addition, an icon with a Check Control message appears on the control display.

#### Icon Possible cause



There is a flat tire or a major tire pressure loss.

### Measure

1. Reduce your speed and come to a stop carefully. Avoid sudden braking and steering maneuvers.
2. Check whether the vehicle is fitted with standard tires or run-flat tires.  
Run-flat tires are indicated by a circular icon containing the letters "RSC" on the tire sidewall.
3. Follow the instructions for what to do in case of a flat tire.

### Actions in the event of a flat tire

#### Standard tires

1. In the event of a flat tire, identify the damaged tire.
2. Check the tire pressure in all four tires, for instance using the tire pressure display of a flat tire kit.

When the tire inflation pressure in all four tires is correct, the flat tire monitor may not have been initialized. Initialize the system.

If no tire damage can be identified, contact an authorized service center or another qualified service center or repair shop.

3. Repair the flat tire, e.g., using a tire repair set or by changing the wheel.

## Runflat tires

### Safety information

#### **WARNING**

The vehicle handles differently when a runflat tire has insufficient or no tire pressure; for instance, reduced directional stability when braking, braking distances are longer and the self-steering properties will change. There is a risk of accident, injury, and property damage. Drive moderately and do not exceed a speed of 50 mph/80 km/h.

#### **WARNING**

Vibrations or loud noises while driving can indicate the final failure of a tire. Tire components may come loose. There is a risk of accident, injury, and property damage. Reduce your speed and stop. Do not continue driving. Contact an authorized service center or another qualified service center or repair shop.

### Maximum speed

You may continue driving with a damaged tire at speeds up to 50 mph/80 km/h.

### Continued driving with a flat tire

Follow the following when continuing to drive with a damaged tire:

- ▶ Avoid sudden braking and steering maneuvers.
- ▶ Do not exceed a speed of 50 mph/80 km/h.
- ▶ Check the tire inflation pressure in all four tires at the next opportunity.

When the tire inflation pressure in all four tires is correct, the flat tire monitor may not have been initialized. In this case, initialize the system.

### Possible driving distance with a flat tire

The possible driving distance which may be safely traveled varies depending on how the vehicle is loaded and used, e.g., speed, road conditions, outside temperature. The distance traveled may be less but may also be more if an economical driving style is used.

If the vehicle is loaded with an average weight and used under favorable conditions, the possible distance traveled may be up to 50 miles/80 km.

### Vehicle handling with damaged tires

Vehicles driven with a damaged tire will handle differently, potentially leading to conditions such as the following:

- ▶ Greater likelihood of skidding of the vehicle.
- ▶ Longer braking distances.
- ▶ Changed self-steering properties.

Modify your driving style. Avoid abrupt steering or driving over obstacles, for instance curbs or potholes.

## System limits

The flat tire monitor may react with a delay or malfunction in the following situations:

- ▶ A natural, even tire pressure loss in all four tires will not be recognized. Therefore, check the tire inflation pressure regularly.
- ▶ Sudden and serious tire damage caused by external circumstances cannot be recognized in advance.
- ▶ The system has not been initialized.
- ▶ When driving on a snow-covered or slippery road.
- ▶ For sporty driving, e.g., due to slippage on the drive wheels or high lateral acceleration.
- ▶ When driving with snow chains.

## Repairing a flat tire

If you get a flat tire, take the following safety precautions:

- ▶ Park the vehicle on solid and non-slip ground at a safe distance from road traffic.
- ▶ Switch on the hazard warning lights.
- ▶ Engage the parking brake.
- ▶ Turn the steering wheel until the front wheels are in the straight-ahead position and engage the steering wheel lock.
- ▶ As soon as permitted by the traffic flow, have all vehicle occupants get out and make sure that they remain outside the hazardous area such as behind a guardrail.
- ▶ If necessary, set up the hazard triangle or hazard warning lights at a suitable distance.

Repair the flat tire, e.g., using a tire repair set or by changing the wheel.

## Tire repair set

### Principle

The tire repair set is used to temporarily seal minor tire damage so that it is possible to continue driving.

The filled in tire sealant closes the damage from the inside when it hardens.

The compressor can be used to check the tire inflation pressure.

The tire repair set may be insufficient if the tire damage measures more than approx. 0.16 in / 4 mm.

### General information

- ▶ Follow the instructions for using the tire repair set, which are provided on the compressor and sealant bottle.
- ▶ Do not remove foreign objects that have penetrated the tire. Remove foreign objects

only when they are visibly protruding from the tire.

### Overview

#### Storage

Depending on vehicle equipment, the tire repair set is stored as follows:

- ▶ In the cargo area under the cargo area floor.
- ▶ In the cargo area on the left or right side.
- ▶ In the cargo area behind a side trim panel.

#### Sealant bottle and filler hose

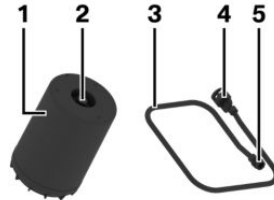

- 1 Sealant bottle
- 2 Sealant bottle outlet
- 3 Filler hose
- 4 Sealant bottle connection
- 5 Wheel valve connection

#### Compressor

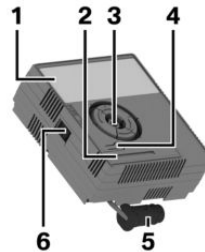

- 1 Compressor
- 2 Tire pressure display

- 3 Sealant bottle mount
- 4 Pressure reducing valve button
- 5 Connector for socket
- 6 Power switch

## Safety precautions

When using the tire repair set, take the following safety precautions:

- ▶ Park the vehicle as far away as possible from passing traffic and on solid ground.
- ▶ Switch on the hazard warning lights.
- ▶ Engage the parking brake.
- ▶ Turn the steering wheel until the front wheels are in the straight-ahead position and engage the steering wheel lock.
- ▶ As soon as permitted by the traffic flow, have all vehicle occupants get out and make sure that they remain outside the hazardous area such as behind a guardrail.
- ▶ If necessary, set up the hazard triangle or hazard warning lights at a suitable distance.
- ▶ Remove the warning label for the maximum permissible speed from the sealant bottle and attach it in the visible area in the vehicle interior.

## Preparing the tire repair set

1. To prepare the tire repair set, place the sealant bottle into the holder on the compressor housing.



2. Turn the sealant bottle clockwise by 90° to the stop.

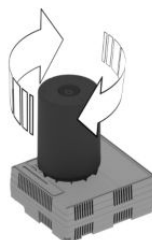

3. Connect the filler hose to the outlet of the sealant bottle and turn clockwise by 90° to the stop.



4. Unscrew the valve cap on the wheel.

- Screw the filler hose connector onto the tire valve.

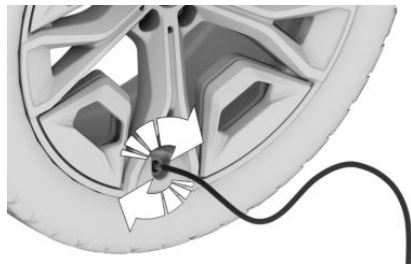

- With the compressor switched off, insert the connector into the power socket in the vehicle interior.

## Sealant

### Safety information

#### DANGER

If the exhaust pipe is blocked or ventilation is insufficient, harmful exhaust gases can penetrate the vehicle. The exhaust gases contain pollutants which are colorless and odorless. In enclosed areas, exhaust gases can also accumulate outside of the vehicle. There is a danger to life. Keep the exhaust pipe free and ensure sufficient ventilation.

#### NOTICE

The compressor can overheat during extended operation. There is a risk of property damage. Do not run the compressor for more than 10 minutes.

### Filling the tire with sealing compound

- With standby state or drive-ready state switched on, switch on the compressor. When adding sealant, the Tire Pressure Monitor may briefly rise up to approx. 6 bar/87 psi before it shows the actual tire

pressure again. Do not turn off the compressor at this stage.

- Switch off the compressor when you reach a tire pressure of 2.5 bar/36 psi.

## Checking the tire pressure

### General information

To check the tire pressure, read the tire pressure gauge on the compressor. The tire pressure must be at least 2.5 bar/36 psi.

### Tire pressure too high

If the tire pressure is too high, reduce the tire pressure with the pressure reducing valve on the compressor.

### Minimum tire pressure not reached

Do not continue driving unless a minimum tire pressure of 2.5 bar/36 psi is reached. Contact an authorized service center or another qualified service center or repair shop.

### Minimum tire pressure reached

When the tire pressure is at least 2.5 bar/36 psi, proceed as follows:

- Pull the connector out of the socket in the vehicle interior.
- Disconnect the hose from the sealant bottle and from the tire valve.
- Screw the valve cap onto the tire valve.
- Stow the tire repair set in the cargo area.
- Immediately drive 6 miles/10 km to ensure that the tire sealant is evenly distributed in the tire.

Do not exceed the speed limit of 50 mph/80 km/h.

If possible, do not drive at speeds less than 12 mph/20 km/h.

Tire sealant may spray from the damaged area when you rotate the wheel initially.

## Adjusting the tire pressure

To adjust the tire pressure after using the tire repair set, proceed as follows:

1. Stop at a suitable location.
2. Connect the filler hose directly to the compressor and turn it 90° clockwise until it engages audibly.
3. Unscrew the valve cap from the wheel and screw the filler hose connector onto the tire valve.

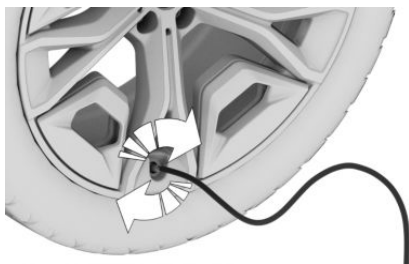

4. Insert the connector into the socket in the vehicle interior.
5. Read the tire pressure on the tire pressure display of the compressor.

Do not continue driving unless a minimum tire pressure of 1.3 bar/19 psi is displayed. Contact an authorized service center or another qualified service center or repair shop.

6. Correct the tire pressure to 2.5 bar/36 psi.
  - ▶ To increase the tire pressure when standby or drive-ready state is on: Turn on the compressor and let it run for max. 10 minutes.
  - ▶ To decrease the tire pressure: press the pressure reducing valve button on the compressor.

## Removing and stowing the tire repair set

To remove and stow the tire repair set, proceed as follows:

1. Switch off the compressor.
2. Pull the connector out of the socket in the vehicle interior.
3. Disconnect the hose from the compressor and from the tire valve.
4. Screw the valve cap onto the tire valve.
5. Stow the tire repair set together with the hose in the cargo area.

## Continuing the trip

Continue driving immediately once finished with the tire repair set.

Do not exceed the speed limit of 50 mph/80 km/h.

Do not exceed the maximum travel distance of 125 miles/200 km.

Re-initialize the flat tire monitor or reset the Tire Pressure Monitor.

Replace the faulty tire and the sealant bottle from the tire repair set as soon as possible.

Additional information:

- ▶ Flat tire monitor, refer to page 335.
- ▶ Tire Pressure Monitor, refer to page 328.

## System limits

If the tires cannot be made ready to drive, contact an authorized service center or another qualified service center or repair shop.

If your vehicle is equipped with a Tire Pressure Monitor, note the following: using tire sealant can damage the tire pressure sensor. If the tire pressure sensor is damaged, have it replaced at the next opportunity.

## Emergency wheel

### Principle

In the event of a flat tire, one emergency spare wheel maximum can be used as a replacement for defective tires. The emergency wheel is only intended for temporary use until the faulty tire/wheel has been replaced.

### General information

Also check the tire pressure of the spare wheel in the cargo area regularly, and correct as necessary.

If the vehicle is equipped with a Sport brake, the emergency wheel can only be mounted on the rear axle. If there is tire damage on the front axle, the emergency wheel must first be fitted on the rear axle on the same side of the vehicle. The intact wheel of the rear axle can then be mounted on the front axle.

### Safety information

#### **WARNING**

The emergency wheel has particular dimensions. When driving with an emergency wheel, changed handling characteristics may occur, for instance reduced directional stability when braking, longer braking distance, and changed roll steer in the stability limit. There is a risk of accident, injury, and property damage. Drive moderately and do not exceed a speed of 50 mph/80 km/h.

#### **WARNING**

The vehicle can be damaged when the emergency wheel is used for too long. There is a risk of accident, injury, and property damage. Drive moderately and do not exceed a driving distance of 600 miles/1,000 km.

### Overview

The emergency wheel and wheel change set are located in the cargo area under the cargo area floor.

### Removing the emergency wheel

1. Pull up and remove the cargo area floor.
2. Loosen the wing screw.
3. Remove the bracket or cover.
4. Remove the jacking point next to the emergency wheel.
5. Push the emergency spare wheel to the left and remove it.

### Inserting the emergency wheel

1. To insert the emergency wheel, insert the emergency wheel on the left-hand side and slide it to the right.
2. Insert and secure the jacking point next to the emergency wheel.
3. Position the holder or cover.
4. Screw on and tighten the wing screw.
5. Insert the cargo area floor.

## Changing wheels/tires

### General information

When using runflat tires or a flat tire kit, a wheel does not always need to be changed immediately in case of a breakdown when there is a tire pressure loss due to a flat tire.

If necessary, a suitable wheel change tool, e.g., a jack, is available as an accessory from an authorized service center or another qualified service center or repair shop.

## Safety information

### **WARNING**

The jack is only provided for short-term lifting of the vehicle for wheel changes. Even if all safety precautions are observed, there is a risk of the raised vehicle falling if the jack tips over. There is a risk of injury and danger to life. When the vehicle is raised with the jack, do not lie under the vehicle and do not switch on the drive-ready state.

### **WARNING**

Placing supports, e.g., wooden blocks or similar, under the jack may reduce its ability to bear weight because of the limited height. The load-carrying capacity of the wooden blocks may be exceeded and the vehicle may tip over. There is a risk of injury and danger to life. Do not place supports under the jack.

### **WARNING**

The jack, issued by the vehicle manufacturer, is provided in order to perform a wheel change in the event of a breakdown. The jack is not designed for frequent use, e.g., changing from summer to winter tires. Using the jack frequently may cause it to become jammed or damaged. There is a risk of injury and risk of property damage. Only use the jack to change an emergency or spare wheel in the event of a breakdown.

### **WARNING**

The jack may slip on soft, uneven, or slippery ground, e.g., snow, ice, tiles, etc. There is a risk of injury. If possible, change the wheel on a flat, solid, slip-resistant surface.

### **WARNING**

The jack is optimized for lifting the vehicle and for the jacking points on the vehicle only. There is a risk of injury. Do not lift any other vehicle or cargo using the jack.

### **WARNING**

When the jack is not inserted into the jacking point provided for this purpose, the vehicle may be damaged or the jack may slip when it is being cranked up. There is a risk of injury and risk of property damage. When cranking up the jack, ensure that it is inserted in the jacking point next to the wheel well.

### **WARNING**

A vehicle that is raised on a jack may fall off of the jack if lateral forces are exerted on it. There is a risk of injury and risk of property damage. While the vehicle is raised, do not exert lateral effort on the vehicle or pull abruptly on the vehicle. Have a stuck wheel removed by an authorized service center or another qualified service center or repair shop.

### **NOTICE**

Using an impact wrench to loosen or tighten the wheel lock bolt can damage the wheel lock bolt. There is a risk of property damage. Only use a lug wrench to loosen and tighten the lug bolt lock.

## Securing the vehicle against rolling away

### General information

The vehicle manufacturer recommends securing the vehicle to prevent it from rolling away when changing a wheel, in addition to engaging the parking brake.

### On a level surface



Place chocks or other suitable objects in front and behind the wheel that is diagonal to the wheel being changed.

### On a slight downhill gradient



Place wheel chocks or other suitable objects, e.g., rocks, under the wheels of the front axle and rear axle, opposite the rolling direction.

## Lug bolt lock

### Principle

The wheel bolt lock offers effective protection against wheel theft.

The locking lug bolts are specifically coded. The lug bolts can only be released with the adapter which matches the coding.

### Overview

Depending on vehicle equipment, store the lug bolt lock adapter as follows:

- ▷ In the cargo area under the cargo area floor.
- ▷ In the cargo area on the left or right side.
- ▷ In the cargo area behind a side trim panel.

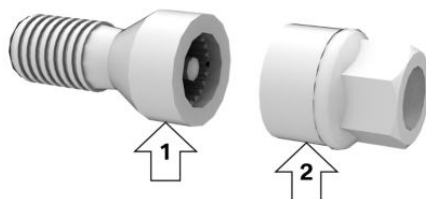

- ▷ Locking lug bolt, arrow 1.
- ▷ Adapter, arrow 2.

### Unscrewing the locking lug bolt

1. To unscrew the locking lug bolt, place the adapter onto the wheel lock.
2. Unscrew the locking lug bolt.
3. Remove the adapter after unscrewing the lug bolt.

### Screwing on the locking lug bolt

1. To screw on the locking lug bolt, place the adapter onto the locking lug bolt. Turn the adapter as necessary until it fits onto the locking lug bolt.
2. Screw on the locking lug bolt. The tightening torque is 101 lbs ft/140 Nm.
3. After screwing on, remove the adapter again.

## Safety precautions

Take the following safety measures when changing a wheel:

- ▶ Park the vehicle on solid and non-slip ground at a safe distance from road traffic.
- ▶ Switch on the hazard warning lights.
- ▶ Engage the parking brake.
- ▶ Turn the steering wheel until the front wheels are in the straight-ahead position and engage the steering wheel lock.
- ▶ Engage a gear or selector lever position P.
- ▶ As soon as permitted by the traffic flow, have all vehicle occupants get out and make sure that they remain outside the hazardous area such as behind a guardrail.
- ▶ If necessary, set up the hazard triangle or hazard warning lights at a suitable distance.
- ▶ Depending on vehicle equipment, remove the wheel change set and, if necessary, the emergency wheel from the vehicle.
- ▶ Secure the vehicle so that it does not roll away.
- ▶ Loosen the lug bolts a half turn.

## Jacking points

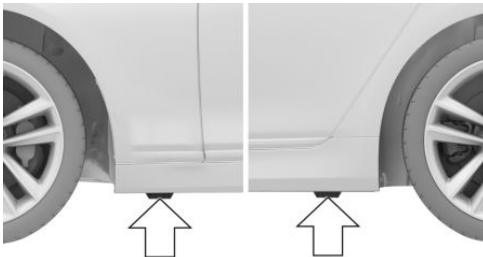

The jacking points are located at the indicated positions.

## Jacking up the vehicle

### WARNING

Hands and fingers can be jammed when using the jack. There is a risk of injury. Comply with the described hand position and do not change this position while using the jack.

To raise the vehicle so that you can change a wheel, proceed as follows:

1. Hold the jack with one hand, arrow 1. With the other hand, grip the jack crank handle or the lever, arrow 2.

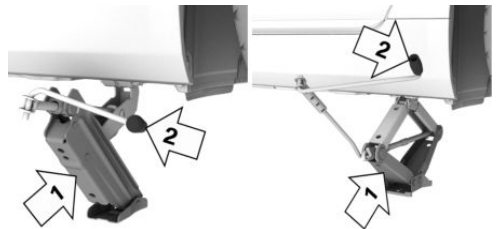

2. Insert the jack into the rectangular recess of the jacking point closest to the wheel to be changed.

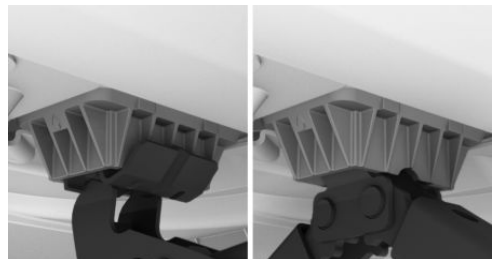

3. Extend the jack by turning the jack crank handle or lever clockwise.



4. Take your hand away from the jack as soon as the jack is under load and continue turning the jack crank handle or lever with one hand.
5. Make sure that the jack foot is extended vertically and that the jack's entire face is on the ground.

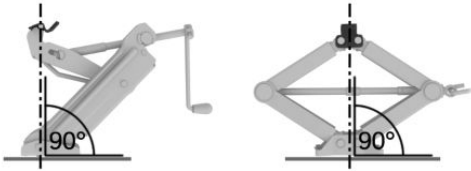

6. Extend the jack until the corresponding wheel is raised max. 1.2 in / 3 cm from the ground.

## Mounting a wheel

Mount one emergency wheel only, as required.

To change a wheel, proceed as follows:

1. Unscrew the lug bolts.
2. Remove the wheel.
3. Put the new wheel or emergency wheel on and screw in at least two lug bolts in a crosswise pattern until hand-tight.

When non-original light-alloy wheels of the vehicle manufacturer are mounted, the ac-

companying lug bolts may have to be used as well.

4. Hand-tighten the remaining lug bolts and tighten all lug bolts well in a crosswise pattern.
5. Turn the jack crank handle counterclockwise to retract the jack and lower the vehicle.
6. Remove the jack and stow it securely.

## After the wheel change

After changing the wheel, do the following:

1. Tighten the lug bolts crosswise. The tightening torque is 101 lbs ft/140 Nm.
2. Stow the faulty wheel in the cargo area, if necessary.
3. Check the tire pressure at the next opportunity and correct as necessary.
4. Re-initialize the flat tire monitor or reset the Tire Pressure Monitor.
5. Check to make sure the lug bolts are tight with a calibrated torque wrench.
6. Drive to the nearest authorized service center or another qualified service center or repair shop, then have the damaged tire replaced.

# Engine compartment

## Vehicle features and options

This chapter describes model-specific equipment, systems, and functions that are currently

available, or may become available in the future, even if they are not present in the vehicle.

Additional information:

Vehicle equipment, refer to page 8.

## Overview

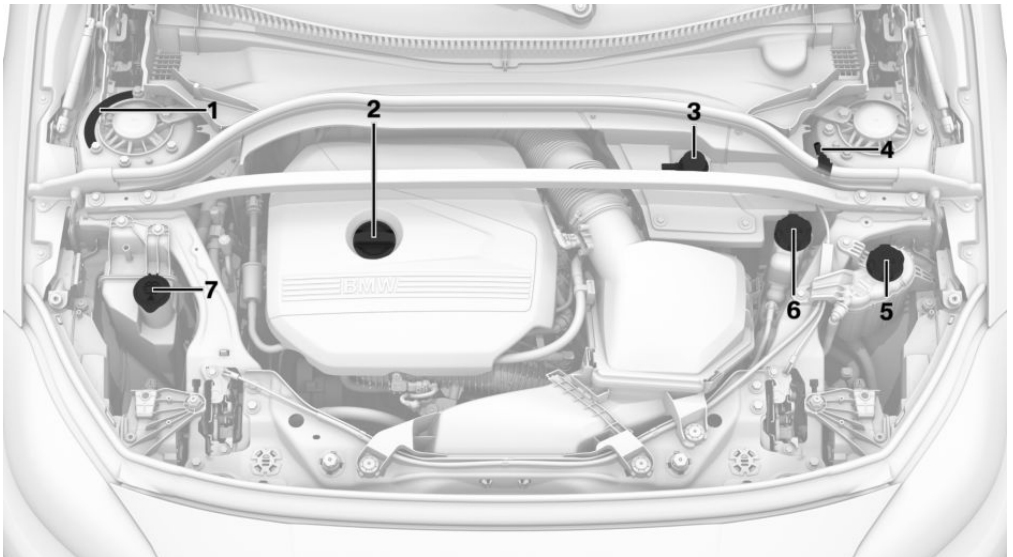

- |   |   |
|---|---|
| <p><b>1</b> Vehicle identification number</p> <p><b>2</b> Oil filler neck</p> <p><b>3</b> Jump-starting, positive battery terminal</p> <p><b>4</b> Jump-starting, negative battery terminal</p> | <p><b>5</b> Depending on motorization: coolant reservoir for additional radiator</p> <p><b>6</b> Coolant reservoir, engine</p> <p><b>7</b> Filler neck for washer fluid</p> |
|---|---|

# Hood

## Safety information

### WARNING

Improperly executed work in the engine compartment can damage components and lead to a safety hazard. There is a risk of accident, injury, and property damage. The vehicle manufacturer recommends having work in the engine compartment performed by an authorized service center or another qualified service center or repair shop.

### WARNING

The engine compartment accommodates moving components. Certain components in the engine compartment can also move with the vehicle switched off, for instance the radiator fan. There is a risk of injury. Do not reach into the area of moving parts. Keep articles of clothing and hair away from moving parts.

### WARNING

There are protruding parts, for instance locking hooks, on the inside of the hood. There is a risk of injury. If the hood is open, pay attention to protruding parts and keep clear of these areas.

### WARNING

An incorrectly locked hood can open while driving and restrict visibility. There is a risk of accident, injury, and property damage. Stop immediately and correctly close the hood.

### WARNING

Body parts can be jammed when opening and closing the hood. There is a risk of injury. Make sure that the travel path of the hood is clear while opening and closing.

### NOTICE

Folded-out wipers can be jammed when the hood is opened. There is a risk of property damage. Make sure that the wipers with the wiper blades mounted are folded down onto the windshield before opening the hood.

### NOTICE

When closed, the hood must engage fully. Pressing again can damage the hood. There is a risk of property damage. Open the hood again and then close it energetically. Avoid pressing again.

## Opening hood

1. In the footwell, pull the lever to open the hood, arrow 1.

The hood is unlocked.



2. Release the lever and pull it again, arrow 2. The hood can be opened.
3. Be careful of protruding parts on the hood.

## Closing the hood

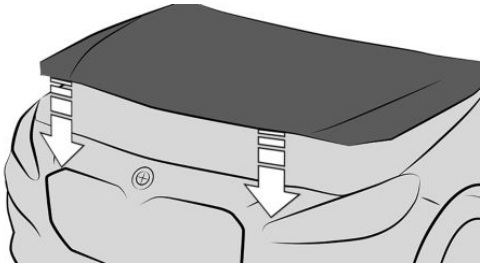

Close the hood with force if it is open by more than approx. 20 in/50 cm.

The hood must engage on both sides.

# Operating fluids

## Vehicle features and options

This chapter describes model-specific equipment, systems, and functions that are currently available, or may become available in the future, even if they are not present in the vehicle.

Additional information:

Vehicle equipment, refer to page 8.

## Fuel recommendation

### General information

Depending on the region, many filling stations sell fuel that has been customized to winter or summer conditions. Fuel that is available in winter, for instance helps make a cold start easier.

### Gasoline

#### General information

For the best fuel efficiency, gasoline should be sulfur-free or have a low sulfur content.

Do not use any fuels that contain metal, as indicated by the label on the gas pump.

Fuels with a maximum ethanol content of 10 %, i.e., E10, may be used for refueling.

The power and consumption specifications correspond to operation with 98 RON E10 fuel.

Knocking noises, strange sounds, and driving issues may occur when using fuel with an ethanol content of 10 % to max. 15 %. These have no effect on the engine service life.

## Safety information

### **Caution**

The use of poor-quality fuels may result in harmful engine deposits or damage. Additionally, problems relating to drivability, starting and stalling, especially under certain environmental conditions such as high ambient temperature and high altitude, may occur.

If drivability problems are encountered, we recommend switching to a high quality gasoline brand and a higher octane grade — AKI number — for a few tank fills. To avoid harmful engine deposits, it is highly recommended to purchase gasoline from Top Tier retailers.

Failure to comply with these recommendations may result in the need for additional maintenance.

### **WARNING**

Even small quantities of the wrong fuel or wrong fuel additives can damage the fuel system and engine. Furthermore, the catalytic converter can be permanently damaged. There is a risk of injury and risk of property damage. Do not refuel or add the following in the case of gasoline engines:

- ▷ Leaded gasoline.
- ▷ Metallic additives, for instance manganese or iron.

Do not turn on standby after refueling with the wrong fuel. Contact an authorized service center or another qualified service center or repair shop.

**⚠ NOTICE**

87 AKI fuel or lower can cause the engine to malfunction or become damaged. There is a risk of property damage. Do not refuel with 87 AKI fuel or lower.

**⚠ NOTICE**

Incorrect fuels can damage the fuel system and the engine. There is a risk of property damage. Do not use fuels with a higher ethanol content than recommended. Do not refuel with fuels containing methanol, e.g. M5 to M100.

## Recommended gas quality

91 AKI.

M Performance model:

93 AKI.

## Minimum fuel grade

87 AKI.

Using fuel with this minimum AKI rating may result in driving issues and strange sounds. Knocking noises may occur, especially when starting the engine at high temperatures. This has no effect on engine service life.

## Engine oil

### Principle

The engine oil consumption and engine oil properties depend on the driving style and operating conditions.

Therefore, regularly check the engine oil level after refueling by taking a detailed measurement.

The engine oil consumption may increase in the following situations, for example:

- ▷ Using a sporty driving style.
- ▷ Break-in of the engine.
- ▷ Idle operation of the engine.
- ▷ With use of engine oil types that are not recommended.

Different Check Control messages appear on the control display depending on the engine oil level and engine oil properties.

The vehicle manufacturer recommends having engine oil changed by an authorized service center or another qualified service center or repair shop. The suitable viscosity grade is indicated on a sign in the engine compartment.

## Safety information

**⚠ NOTICE**

An engine oil level that is too low causes engine damage. There is a risk of property damage. Immediately add engine oil.

**⚠ NOTICE**

Too much engine oil can damage the engine or the catalytic converter. There is a risk of property damage. Do not add too much engine oil. If there is excess engine oil, have the engine oil level corrected by an authorized service center or another qualified service center or repair shop.

**⚠ NOTICE**

Engine oil that is not changed in timely fashion can cause increased engine wear and thus engine damage. There is a risk of damage to property. It is recommended that you do not exceed the service intervals indicated in the vehicle.

## Electronic oil measurement

### Principle

The electronic oil measurement has two measuring principles:

- ▷ Monitoring.
- ▷ Detailed measurement.

Perform a detailed measurement regularly if making frequent short-distance trips or using a sporty driving style, e.g., cornering at speed.

### Monitoring

#### Principle

The engine oil level is monitored electronically while driving and can be shown on the control display.

If the engine oil level is outside its permissible operating range, a Check Control message is displayed.

#### Functional requirements

To perform the electronic oil measurement, the following functional requirement must be met:

A current measured value is available after approx. 30 minutes of normal driving.

#### Displaying the engine oil level

To display the engine oil level on the control display, go through the menu as follows: Apps menu / "Vehicle" / "Vehicle status" / "Engine oil level".

#### System limits

When making frequent short-distance trips or using a sporty driving style, it may not be possible to calculate a measured value. In this case, the measured value for the last, sufficiently long trip is displayed.

## Detailed measurement

### Principle

During a detailed measurement, the engine oil level is checked when the vehicle is stationary and displayed on a scale.

If the engine oil level is outside its permissible operating range, a Check Control message appears on the control display.

#### General information

The idle speed increases slightly while the engine oil level is measured.

#### Functional requirements

The following functional requirements apply for detailed measurement:

- ▷ The vehicle is parked in a horizontal position.
- ▷ Drive-ready state is turned on by pressing the Start/Stop button.
- ▷ The engine is at operating temperature.
- ▷ Selector lever is in selector lever position N or P and accelerator pedal is not pressed.

#### Performing a detailed measurement

To perform a detailed measurement of the engine oil level, go through the menu as follows: Apps menu / "Vehicle" / "Vehicle status" / "Engine oil level" / "Oil level measurement" / "Start measurement".

The engine oil level is checked and displayed via a scale.

## Adding engine oil

### Principle

Only add engine oil when the message is displayed on the instrument cluster. The top-up quantity is indicated in the message shown on the control display.

Only add suitable types of engine oil.

Safely park the vehicle and turn off drive-ready state before adding engine oil.

Take care not to add too much engine oil.

## Safety information

### WARNING

Operating fluids, e.g., oil, grease, coolant, fuel, may contain harmful ingredients. There is a risk of injury and danger to life. Follow the instructions on the containers. Do not allow operating fluids to come into contact with your clothing, skin, or eyes. Do not fill operating fluids into different bottles. Store operating fluids out of reach of children.

### NOTICE

An engine oil level that is too low causes engine damage. There is a risk of property damage. Immediately add engine oil.

### NOTICE

Too much engine oil can damage the engine or the catalytic converter. There is a risk of property damage. Do not add too much engine oil. If there is excess engine oil, have the engine oil level corrected by an authorized service center or another qualified service center or repair shop.

## Overview

The oil filler neck is located in the engine compartment.

Additional information:

For an overview, refer to page [347](#).

## Adding engine oil

To top up the engine oil, proceed as follows:

1. Opening the hood.
2. Turn the lock in the engine compartment counterclockwise.



3. Add engine oil.
4. Close the cap in the engine compartment.

Additional information:

Opening the hood, refer to page [348](#).

## Engine oil types to add

### General information

The engine oil grade is critical for the service life of the engine.

Only add with the types of engine oil which are listed.

### Safety information

#### NOTICE

Oil additives can damage the engine. There is a risk of property damage. Do not use oil additives.

**NOTICE**

Incorrect engine oil can cause malfunctions in the engine or damage it. There is a risk of property damage. When selecting an engine oil, make sure that the engine oil has the correct oil specification.

## Suitable engine oil types

When topping up engine oil, the following oil specification applies:

### Gasoline engine

BMW Longlife-17 FE+.

## Alternative engine oil types

If an engine oil suitable for continuous use is not available, up to 1 US quart/liter of an engine oil with the following oil rating can be added:

### Oil specification

API SL.

API SM.

API SN.

## Viscosity grades

When selecting an engine oil, make sure that the engine oil has a suitable viscosity grade. The suitable viscosity grade is indicated on a sign in the engine compartment.

More information about suitable oil specifications and engine oil viscosity grades can be requested from an authorized service center or another qualified service center or repair shop.

**BMW recommends  
Original BMW Engine Oil.**

## Coolant

### General information

The coolant consists of water and a coolant additive.

Not all commercially available additives are suitable for the vehicle. The vehicle manufacturer recommends using coolant with the BMW LC-18 specification. Do not mix additives of different colors. Observe the water - additive mixture ratio of 50:50. For information on suitable additives, contact an authorized service center or another qualified service center or repair shop.

### Safety information

**WARNING**

With the engine hot and the cooling system open, coolant can escape and lead to scalding. There is a risk of injury. Only open the cooling system with the engine cooled down.

**WARNING**

Additives are harmful to health. Using the wrong additives can damage the engine. There is a risk of injury and risk of property damage. Do not allow additives to come into contact with skin, eyes or articles of clothing. Use suitable additives only.

**NOTICE**

Too much water reduces the coolant's frost protection and corrosion protection. There is a risk of property damage. Use a 50:50 mixing ratio of water to coolant additive.

## Coolant level

### General information

Depending on the drive variant, there are up to two coolant reservoirs in the engine compartment. Check coolant levels on a regular basis and refill as necessary.

The coolant reservoir may be overfilled with coolant when the vehicle is delivered from the factory or following maintenance measures. The specified coolant level is achieved with longer operating periods.

The nominal coolant level is indicated by the maximum mark in the filler neck of the coolant reservoir.

Additional information:

For an overview, refer to page [347](#).

### Checking the coolant level

To check the coolant level, proceed as follows.

1. Allow the engine to cool down.
2. Turn off the climate control system.
3. Opening the hood.
4. Turn the coolant reservoir cap slightly counterclockwise until the excess pressure dissipates.
5. Open the coolant reservoir cap.
6. The coolant level is correct when it is just below the max. level mark on the filler neck.  
This can be found on the filler neck or on the outside of transparent coolant tanks.
7. Close the coolant reservoir cap.

Additional information:

Climate control, refer to page [270](#).

Opening the hood, refer to page [348](#).

### Adding coolant

To refill the coolant, proceed as follows:

1. Allow the engine to cool down.
2. Turn off the climate control system.
3. Opening the hood.
4. Turn the coolant reservoir cap slightly counterclockwise until the excess pressure dissipates.
5. Open the coolant reservoir cap.
6. If necessary, slowly add coolant up to the specified fill level. Be careful not to spill coolant.
7. Close the coolant reservoir cap.

Additional information:

Climate control, refer to page [270](#).

Opening the hood, refer to page [348](#).

### Disposal



Comply with the relevant environmental protection regulations when disposing of coolant and coolant additives.

## Washer fluid

### Principle

Washer fluid is used to clean the windshields and sensors. All spray nozzles are supplied from one tank.

Use a mixture of tap water and windshield washer concentrate. If desired, a windshield washer concentrate containing antifreeze can be used.

The recommended minimum fill quantity is 0.5 US gal/2 liters.

## Safety information

### Warning

Some types of antifreeze can contain harmful substances and are flammable. There is a risk of fire and an injury hazard. Follow the instructions on the containers. Keep antifreeze away from ignition sources. Do not fill operating fluids into different bottles. Store operating fluids out of reach of children.

United States: The washer fluid mixture ratio is regulated by the U.S. EPA and many individual states; do not exceed the allowable washer fluid dilution ratio limits that apply. Follow the usage instructions on the washer fluid container.

Use of BMW's Windshield Washer Concentrate or the equivalent is recommended.

### WARNING

Washer fluid can ignite and catch fire on contact with hot engine parts. There is a risk of injury and risk of property damage. Only add washer fluid when the engine is cooled down. Next, fully close the lid of the washer fluid reservoir.

### NOTICE

Silicon-based additives in the washer fluid, which are used to repel water on window glass, can cause damage to the car wash. There is a risk of property damage. Do not add silicon-containing additives to the washer fluid.

### NOTICE

Mixing different windshield washer fluid concentrates or antifreeze can damage the washer system. There is a risk of property damage. Do not mix different windshield

washer fluid concentrates or antifreeze. Follow the information and mixture ratios provided on the containers.

## Overview



The washer fluid reservoir is located in the engine compartment on the right side of vehicle.

## Refilling washer fluid

To refill the washer fluid, proceed as follows:

1. Opening the hood.
2. Open the cap and refill the washer fluid.
3. Close the cover.

Additional information:

Opening the hood, refer to page [348](#).

## Malfunction

The use of undiluted windshield washer fluid concentrate or alcohol-based antifreeze can lead to incorrect readings at temperatures below +5°F/-15°C.

# Maintenance

## Vehicle features and options

---

This chapter describes model-specific equipment, systems, and functions that are currently available, or may become available in the future, even if they are not present in the vehicle.

Additional information:

Vehicle equipment, refer to page 8.

## Maintenance system

---

### Principle

The maintenance system provides service notifications and thereby provides support in maintaining road safety and the operational reliability of the vehicle.

### General information

In some cases, scopes and intervals of the maintenance system may vary according to the country version. Replacement work, spare parts, fuels and lubricants, and wear materials are calculated separately. Further information is available from an authorized service center or another qualified service center or repair shop.

## Condition Based Service

---

### Principle

Condition Based Service determines the maintenance recommendation using sensors and special algorithms that take into account the operating conditions of the vehicle.

The maintenance recommendation is determined according to the individual usage profile of the vehicle.

Information on service notifications can be shown on the control display.

Additional information:

Service notifications, refer to page 150.

### Service data in the vehicle key

Information on the service notifications is continuously stored in the vehicle key. The service center can read this data out and suggest a maintenance scope for the vehicle.

### Stationary periods

Stationary periods during which the vehicle battery was disconnected are taken into account.

Some maintenance measures are time-dependent, e.g., replacing equipment. Have this maintenance work updated by an authorized service center or another qualified service center or repair shop.

## Maintenance Booklet for US Models

---

Please consult your Maintenance Booklet for additional information on the performance of service and maintenance work.

The manufacturer of your vehicle recommends that maintenance and repair be performed by an authorized service center or another qualified service center or repair shop. Records of regular maintenance and repair work should be retained.

## Diagnostic socket

### Principle

Using the diagnostic socket, the vehicle owner can have data saved to the vehicle read out by an authorized service center or another qualified service center or repair shop.

### General information

The alarm system is triggered when the vehicle is locked while devices are connected to the diagnostic socket.

Disconnect devices from the diagnostic socket before locking the vehicle or starting a Remote Software Upgrade.

### Safety information

#### NOTICE

The diagnostic socket is an intricate component intended to be used in conjunction with specialized equipment to check the vehicle's primary emissions system. Improper use of the diagnostic socket, or contact with the diagnostic socket for other than its intended purpose, can cause vehicle malfunctions and creates risks of personal and property damage. Given the foregoing, it is strongly recommended that access to the diagnostic socket is limited to an authorized service center or another qualified service center or repair shop or other persons that have the specialized training and equipment for purposes of properly utilizing the diagnostic socket.

### Overview

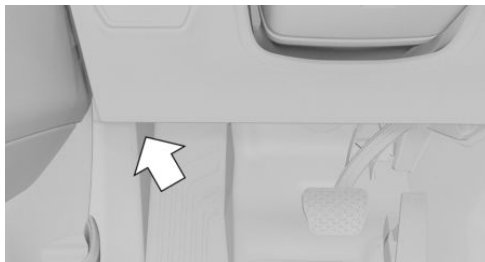

The diagnostic socket for reading out vehicle data is located in the footwell on the driver's side.

### Pollutant emissions



- ▶ The warning light illuminates:
    - The exhaust gas quality is declining, e.g., because the fuel filler cap is fitted incorrectly. Have the vehicle checked as soon as possible.
  - ▶ The warning light flashes under certain circumstances:
    - This indicates that there is excessive misfiring in the engine.
    - Reduce the vehicle speed and have the system checked immediately by an authorized service center or another qualified service center or repair shop. Otherwise, severe engine misfires will very quickly cause serious damage to emissions-related components, especially the catalytic converter.
- Have the vehicle checked by an authorized service center or another qualified service center or repair shop.

## Taking the vehicle out of service

When the vehicle is shut down for longer than three months, some special measures are nec-

essary. For more information, contact an authorized service center or another qualified service center or repair shop.

Additional information:

Deep sleep mode, refer to page [40](#).

# Replacing components

## Vehicle features and options

This chapter describes model-specific equipment, systems, and functions that are currently available, or may become available in the future, even if they are not present in the vehicle.

Additional information:

Vehicle equipment, refer to page 8.

## Onboard vehicle tool kit

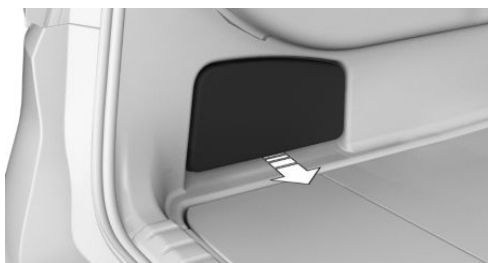

The onboard toolkit is located in the cargo area behind the left side trim panel.

## Wiper blades

### Safety information

 **NOTICE**

The window glass may be damaged if the wiper is set onto it without a wiper blade. There is a risk of property damage. Hold the wiper firmly when changing the wiper blade. Do not fold in or switch on the wiper without a wiper blade installed.

 **NOTICE**

Folded-out wipers can be jammed when the hood is opened. There is a risk of property damage. Make sure that the wipers with the wiper blades mounted are folded down onto the windshield before opening the hood.

### Replacing the wiper blades

To replace the wiper blades, proceed as follows:

1. Move the wipers to the fold-out position.
2. Lift the wipers off the windshield and hold.



3. Press the button on the wiper, arrow 1, turn the wiper blade clockwise slightly, then pull it forward and out, arrow 2.

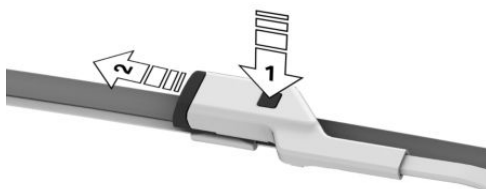

4. Insert the new wiper blade by pressing it on until you hear it snap into the holder.
5. Fold in the wipers.

Additional information:

Fold-out position of the wipers, refer to page 162.

## Bulbs and lights

### Principle

The bulbs and lights contribute significantly to driving safety.

All headlights and lights are designed using LED technology at least.

In the event that they are no longer operating properly, have the headlights and lights checked by an authorized service center or another qualified service center or repair shop.

### Safety information

#### **WARNING**

Intense brightness can irritate or damage the retina of the eye. There is a risk of injury. Do not look directly into the headlights or other light sources. Do not remove the LED covers.

### Headlight glass

The inside of the headlight glass may fog up in cool or damp weather. Condensation will disappear after a short time when driving with the lights on. The headlight glass does not need to be changed.

If, despite driving with the headlights switched on, moisture such as water droplets increasingly forms in the light, have the headlights checked.

## Vehicle battery

### Principle

The vehicle battery is maintenance-free.

In the event of a malfunction, the vehicle manufacturer recommends having any correspond-

ing work, e.g., replacing the vehicle battery, performed by an authorized service center or another qualified service center or repair shop.

More information on the vehicle battery can be requested from an authorized service center or another qualified service center or repair shop.

### Safety information

#### **WARNING**

Contact with live components can lead to an electric shock. There is a risk of injury, danger to life, and risk of property damage. Do not touch any components that are under voltage.

#### **WARNING**





Vehicle batteries that are not recommended can damage vehicle systems and impair vehicle functions. There is a risk of accident, injury, and property damage. Only use vehicle batteries recommended by the vehicle manufacturer. For information on suitable vehicle batteries, contact an authorized service center or another qualified service center or repair shop.

### Registering the vehicle battery in the vehicle

The vehicle manufacturer recommends having an authorized service center or another qualified service center or repair shop register the vehicle battery to the vehicle after the battery has been changed. Once the battery has been registered again, all comfort features will be available without limitation and any Check Control messages displayed which relate to comfort features will disappear.

## Hazard icons

The following hazard symbols can be found on the vehicle battery:

Icon	Meaning
	No smoking, no open flames, no sparks.
	Wear safety goggles.
	Keep away from children.
	Risk of chemical burn: wear gloves, do not tilt battery.
	Flush acid splashes with water immediately. In the event of contact with the eyes or swallowing, seek a physician immediately.
	No direct daylight, no frost.
	Follow the operating instructions.
	Explosive gas mixture. Do not close any openings of the battery.

## Charging the vehicle battery

### Principle

Make sure that the vehicle battery is always sufficiently charged to ensure that the vehicle battery can be used for its entire service life.

 A discharged battery is indicated by a red indicator light.

Charge the vehicle battery when the drive-off power is insufficient.

The following circumstances can negatively affect the vehicle battery's performance:

- ▷ Frequent short-distance drives.
- ▷ Stationary periods of more than one month.

## Safety information

### WARNING

Battery chargers that charge the vehicle battery from sockets in the vehicle may overload or damage the 12V electrical system. There is a risk of injury and risk of property damage. Only connect battery chargers for the vehicle battery to the jump-start terminals in the engine compartment.

## Charging the vehicle battery

To charge the vehicle battery, first switch off the combustion engine, then use the jump-start terminals in the engine compartment.

With mild hybrid technology: Open the hood before charging the vehicle battery.

Additional information:

Jump-start terminals, refer to page [366](#).

## Power interruption

After a power interruption, some equipment needs to be newly initialized or individual settings updated, for example:

- ▷ Initialize the parking brake.
- ▷ With memory function: Save the positions again.
- ▷ Time: Update.
- ▷ Date: Update.
- ▷ With glass sunroof: Initialize system.

Additional information:

Initialize the parking brake after a power interruption, refer to page [129](#).

## Deep sleep mode

Use deep sleep mode for long stationary periods.

Additional information:

Deep sleep mode, refer to page [40](#).

## Mild Hybrid technology

### Principle

Mild hybrid technology helps to reduce fuel consumption. The mild hybrid technology includes a battery with a voltage of 48 V.

The battery for mild hybrid technology is located below the cargo area floor.

With mild hybrid technology: do not remove the cargo area floor and do not fold up the front part of the cargo area floor.

Additional information:

Cargo area floor, refer to page [297](#).

### Safety information

#### **WARNING**

Contact with live components can lead to an electric shock. There is a risk of injury, danger to life, and risk of property damage. Do not touch any components that are under voltage.

### Notice

Do not exchange or work on the battery for the Mild Hybrid technology.

### Disposing of old batteries



Have old batteries disposed of by an authorized service center or another qualified service center or repair shop, or take them to a collection point.

Transport and store full vehicle batteries in an upright position. Secure the battery so that it does not tip over during transport.



Batteries contain harmful chemicals. Disposing of batteries with household waste is prohibited by law.

## Fuses

### General information

The fuses are located at different places in the vehicle.

Information on the fuse layout and the positions of the fuse boxes is available on the Internet: [fusecard.bmw.com](http://fusecard.bmw.com).

### Safety information

#### **Warning**

Incorrect and repaired fuses can overload electrical lines and components. There is a risk of fire, injury and a risk of damage to property damage. Never attempt to repair a blown fuse. Do not replace a nonworking fuse with a substitute of another color or amperage rating.

### Replacing fuses

The vehicle manufacturer recommends having the fuses replaced by an authorized service center or another qualified service center or repair shop.

# Breakdown Assistance

## Vehicle features and options

This chapter describes model-specific equipment, systems, and functions that are currently available, or may become available in the future, even if they are not present in the vehicle.

Additional information:

Vehicle equipment, refer to page 8.

## Hazard warning system

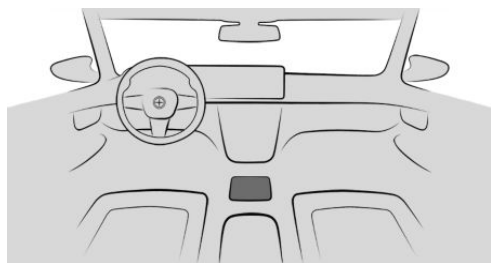

The button for the hazard warning system is located on the center console.

The red light in the button flashes when the hazard warning system is turned on.

## Warning triangle



The warning triangle is located on the inside of the tailgate.

To remove the warning triangle, loosen the holders.

## First-aid kit

Depending on the vehicle equipment and national-market version, the vehicle is equipped with a first-aid kit.

Storage for the first-aid kit is provided in the cargo area.

Some of the articles have a limited service life. Check the expiration dates for the contents regularly, replacing any expired items promptly.

## Emergency Call

### Principle

In case of an emergency, an emergency call can be triggered automatically by the system or manually.

### Intelligent emergency call

The vehicle features an Intelligent Emergency Call system, depending on vehicle equipment.

The Intelligent Assist system establishes a connection with the BMW Response Center.

Intelligent emergency calls are made using a SIM card that is integrated into the vehicle.

The BMW Response Center then makes contact with the occupants of the vehicle and initiates further steps to help.

If an intelligent emergency call is made, the data used to determine necessary rescue measures, e.g., the vehicle's current location if it can be determined, is sent to the BMW Response Center.

Even if the driver is unable to respond, the BMW Response Center can, under certain circumstances, initiate steps to provide further assistance.

Even if the BMW Response Center is no longer heard through the loudspeakers, the BMW Response Center may still be able to hear the occupants of the vehicle.

The BMW Response Center ends the emergency call.

## General information

Only press the SOS button in the headliner in an emergency.

For technical reasons, the emergency call cannot be guaranteed under unfavorable conditions.

## Overview

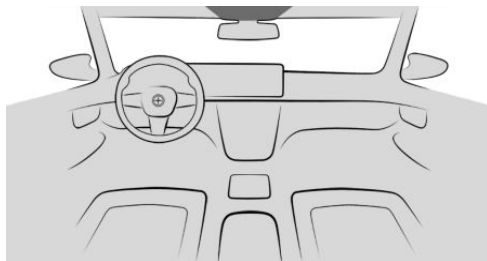

 The SOS button is located in the headliner.

## Functional requirements

To use the emergency call, the following functional requirements must be met:

- ▶ Standby state is switched on.
- ▶ The Emergency Call system is functioning correctly.
- ▶ The integrated SIM card in the vehicle has been activated.

## Automatic triggering

Under certain conditions, for example if the airbags are deployed, an emergency call is automatically triggered immediately after an accident of corresponding severity. Automatic Collision Notification is not affected by pressing the SOS button.

If an emergency call is placed, all other signal tones and audio sources such as the Park Distance Control are muted.

## Manual triggering

To initiate an emergency call manually, proceed as follows:

1. Tap the cover flap of the SOS button to open it.
2. Press and hold the SOS button in the headliner until the LED near the button illuminates green.
  - ▶ The LED is illuminated green when an Emergency Call has been initiated.
 

If a cancel prompt appears on the control display, the emergency call can be aborted. If the situation allows, wait in the vehicle until the voice connection has been established.
  - ▶ The LED flashes green when the connection to the BMW Response Center has been established.

## Malfunction

The function of the emergency call may be impaired.

The LED near the SOS button flashes for approximately 30 seconds. A Check Control message is displayed.

Have the vehicle checked by an authorized service center or another qualified service center or repair shop.

## Jump-starting

### Principle

If the vehicle battery is discharged, the combustion engine can be started using the battery on another vehicle and two jumper cables. Only use jumper cables with fully insulated clamp handles.

### Safety information

#### WARNING

Contact with live components can lead to an electric shock. There is a risk of injury, danger to life, and risk of property damage. Do not touch any components that are under voltage.

#### WARNING

If the jumper cables are connected in the incorrect order, spark formation may occur. There is a risk of injury. Pay attention to the correct order during connection.

#### WARNING

In the case of body contact between the two vehicles, a short circuit can occur while jump-starting. There is a risk of injury and risk of property damage. Make sure that no body contact occurs.

### Preparation

1. Check whether the vehicle battery of the other vehicle has a voltage of 12 volts. The voltage information can be found on the vehicle battery.
2. Switch off the engine on the donor vehicle.
3. Switch off any power consumers in both vehicles.

### Jump-start terminals

The jump-start terminals are located in the engine compartment.

Open the covers of the jump-start terminals.

Additional information:

For an overview, refer to page [347](#).

### Connecting jumper cables

Before starting, turn off all unnecessary electronic systems/components, e.g., radio, on the donor and receiver vehicles.

1. Open the lid of the jump-start terminal.
2. Attach one terminal clamp of the positive jumper cable to the positive battery terminal, or to the corresponding jump-start terminal of the vehicle providing assistance.
3. Attach the second terminal clamp to the positive battery terminal, or to the corresponding jump-start terminal, of the vehicle being started.
4. Attach one terminal clamp of the negative jumper cable to the negative battery terminal, or to the corresponding engine or body ground of assisting vehicle.
5. Attach the second terminal clamp to the negative battery terminal, or to the corresponding engine/body ground, of the vehicle being started.

### Starting the engine

Never use spray fluids to start the engine.

1. Start the engine on the donor vehicle and let it run for several minutes at an increased idle speed.

If the vehicle to be started has a diesel engine: let the engine on the donor vehicle run for approx. 10 minutes.

2. Start the engine on the vehicle to be started as usual.

If the first attempt to start the engine is not successful, wait a few minutes before mak-

ing another attempt in order to allow the discharged battery to recharge.

3. Let both engines run for several minutes.
4. Disconnect the jumper cables again in the reverse order.

Check the vehicle battery and recharge, if needed.

## Tow-starting/towing

### Safety information

#### **Warning**

When towing while safety systems or driver assistance systems are activated, the behavior of the individual systems may lead to an accident, e.g., due to automatic braking or acceleration. There is a risk of accident, injury, and property damage. Do not use the corresponding safety systems or driver assistance systems when towing.

### Pushing the vehicle

To remove a broken-down vehicle from the hazard area, it can be pushed for distances of approx. 328 ft/100 m at a speed of max. 6 mph/10 km/h.

Additional information:

Rolling or pushing the vehicle, refer to page [121](#).

### Without xDrive: transport vehicle

#### Principle

When towing the vehicle, make sure to tow it in the direction of traffic.

The vehicle must be transported by an authorized service center or another qualified service center or repair shop.

### Safety information

#### **WARNING**

The vehicle can become damaged when lifting and securing it. There is a risk of injury and risk of property damage.

- ▷ Only lift the vehicle using a suitable device.
- ▷ Do not lift or secure the vehicle on the towing eye, rims, body components, or chassis components.
- ▷ For transport, secure the vehicle by placing special tire straps over the tire tread surfaces in the vehicle's longitudinal direction.

#### **NOTICE**

The vehicle can be damaged when towing the vehicle while the front wheels are rolling. There is a risk of property damage. The front axle must be raised when the vehicle is towed, and the vehicle must be transported on a loading platform or using a tow dolly. Tow dollies must be used under the rear wheels only. Also make sure that no wheel is touching the ground.

### Tow truck

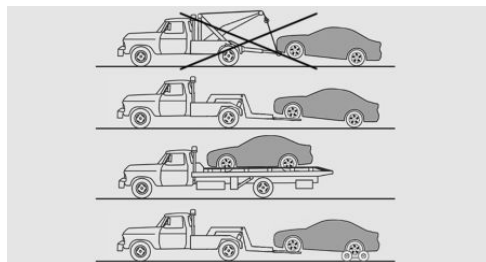

The vehicle should be transported with a tow truck with a so-called spectacle lift or on a loading platform.

When using a tow dolly, make sure that none of the wheels touch the ground. This method should be used for distances of max. 124 miles/200 km. Follow the instructions, as well as specified loads and speeds, given by the tow dolly manufacturer.

## With xDrive: Transporting the vehicle

### Principle

The vehicle must be transported on a loading platform or tow dolly.

The vehicle must be transported by an authorized service center or another qualified service center or repair shop.

### Safety information

#### NOTICE

The vehicle can be damaged when towing the vehicle with a single lifted axle. There is a risk of property damage. Have vehicle transported on a loading platform or use a tow dolly. Tow dollies must be used under the rear wheels only. Also make sure that no wheel is touching the ground.

#### WARNING

The vehicle can become damaged when lifting and securing it. There is a risk of injury and risk of property damage.

- ▷ Only lift the vehicle using a suitable device.
- ▷ Do not lift or secure the vehicle on the towing eye, rims, body components, or chassis components.
- ▷ For transport, secure the vehicle by placing special tire straps over the tire tread surfaces in the vehicle's longitudinal direction.

## Tow truck

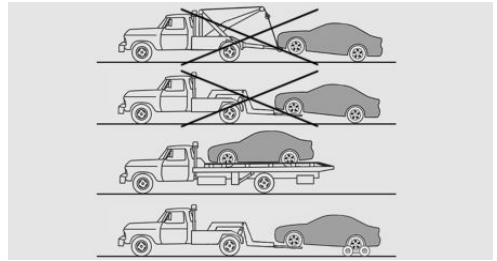

Have vehicle transported on a loading platform or use a tow dolly.

When using a tow dolly, make sure that none of the wheels touch the ground. This method should be used for distances of 200 km/124 miles. Follow the instructions, as well as specified loads and speeds, given by the tow dolly manufacturer.

## Towing other vehicles

### Principle

Switch on the hazard warning system, depending on local regulations.

If the electrical system fails, mark the vehicle being towed clearly by placing a sign or warning triangle in the rear window.

### Safety information

#### WARNING

If the gross vehicle weight of the towing vehicle is lighter than the vehicle to be towed, the towing eye may shear off or the vehicle may become uncontrollable. There is a risk of accident, injury, and property damage. Make sure that the gross vehicle weight of the towing vehicle is heavier than the vehicle to be towed.

**Warning**

Different levels of braking may occur when towing with adaptive recuperation. There is a risk of accident, injury, and property damage. Deactivate adaptive recuperation before towing.

**NOTICE**

If the tow bar or tow rope is attached incorrectly, damage to other vehicle parts can occur. There is a risk of property damage. Correctly attach the tow bar or tow rope to the towing eye.

**Tow bar**

The towing eyes used should be on the same side on both vehicles.

If it is not possible to avoid mounting the tow bar at an incline, note the following:

- ▶ Free movement will be restricted when cornering.
- ▶ The inclination of the tow bar will generate lateral forces.

**Tow rope**

Observe the following notes when using the tow rope:

- ▶ Use nylon ropes or straps, which will enable the vehicle to be towed without jerking.
- ▶ Make sure the tow rope is not twisted when fastening.
- ▶ Check the attachment of the towing eye and tow rope in regular intervals.
- ▶ Do not exceed a towing speed of 30 mph/50 km/h.
- ▶ Do not exceed a towing distance of 3 miles/5 km.
- ▶ When driving off to tow the vehicle, make sure that the tow rope is taut.

**Towing eye****Principle**

The towing eye is a device that can be screwed onto the vehicle in order to, e.g., secure tow cables or tow rods.

**General information**

The screw-in towing eye should always be carried in the vehicle.

The towing eye can be screwed in at the front or rear of the vehicle.

**Safety information****NOTICE**

If the towing eye is not used as intended, there may be damage to the vehicle or to the towing eye. There is a risk of property damage. Follow the notes on using the towing eye.

**Storage**

Depending on vehicle equipment, the towing eye may be stored in a bag as follows:

- ▶ In the cargo area under the cargo area floor.
- ▶ In the cargo area on the left or right side.
- ▶ In the cargo area behind a side trim panel.

**Using the towing eye**

When using the towing eye, note the following:

- ▷ Use only the towing eye provided with the vehicle.
- ▷ Screw in the towing eye, completely and firmly, by turning it at least five turns clockwise. If necessary, tighten with a suitable object.
- ▷ After use, unscrew the towing eye counter-clockwise.
- ▷ Use the towing eye for towing on paved roads only.
- ▷ Avoid lateral loading of the towing eye, for instance do not lift the vehicle by the towing eye.
- ▷ Check the attachment of the towing eye in regular intervals.

## Towing eye thread

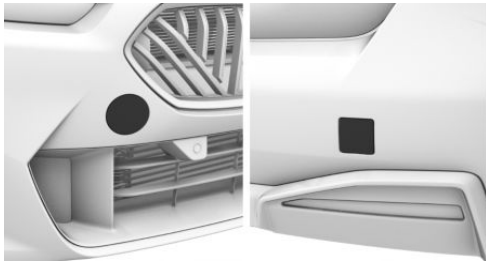

The towing eye thread is located behind a cover on the front and rear bumper.

To remove the cover, press the mark on the edge of the cover. To make removal easier, simultaneously pull on the opposite side of the cover.

## Tow-starting

Do not tow-start the vehicle.

Start the engine by jump-starting, if possible.

Have the cause of starting issues corrected by an authorized service center or another qualified service center or repair shop.

Additional information:

Jump-starting, refer to page [366](#).

# Vehicle care

## Vehicle features and options

This chapter describes model-specific equipment, systems, and functions that are currently available, or may become available in the future, even if they are not present in the vehicle.

Additional information:

Vehicle equipment, refer to page 8.

## Washing the vehicle

### General information

The vehicle must be washed more frequently, especially in the winter.

Foreign objects, e.g. leaves or snow, must be removed from the area below the windshield on a regular basis. The wipers can be folded down in order to clean the windshield completely.

Additional information:

Fold-out position of the wipers, refer to page 162.

### Safety information

#### **WARNING**

When driving, high temperatures can occur underneath the vehicle body, e.g., due to the exhaust system, brakes or radiator. Contact with the hot components can cause burns. There is a risk of injury. Do not touch hot components. Do not perform work in the vicinity of hot components until after they have cooled down.

#### **NOTICE**

When washing with an open fuel filler flap, damage may occur. There is a risk of property damage. Close the fuel filler flap before washing. Clean dirt behind the fuel filler flap with a cloth.

## Steam-jet cleaner and high pressure cleaner

### Safety information

#### **NOTICE**

When using high-pressure cleaners, components can be damaged due to the pressure or high temperatures or because an insufficient distance was maintained. There is a risk of property damage. Make sure that sufficient distance is maintained. Do not spray continuously on one spot. Follow the operating instructions for the high pressure cleaners.

### Distances and temperature

When cleaning with a steam/high-pressure cleaner, make sure to use the specified temperatures and distances.

Maximum temperature: 140 /60°C.

Minimum distance to glass sunroof:  
31.5 in/80 cm.

Minimum distance of 12 in/30 cm to the following components:

- ▷ Sensors.
- ▷ Cameras.
- ▷ Seals.
- ▷ Lights.
- ▷ Air inlets in front of vehicle.

- ▷ Cables.
- ▷ Plug connectors.

## Automatic car washes or car washes

### Safety information

#### NOTICE

High-pressure washers can cause water to enter through the windows. There is a risk of property damage. Do not drive into high-pressure car wash systems.

#### NOTICE

Improper use of automatic car washes can cause damage to the vehicle. There is a risk of property damage. Follow the following instructions:

- ▷ Give preference to cloth car washes or those that use soft brushes in order to avoid paint damage.
- ▷ Note the permissible vehicle dimensions for the car wash.
- ▷ Do not drive through a car wash with guide rails higher than 4 in/10 cm to avoid damage to the body.
- ▷ Observe the tire width of the guide rail to avoid damage to tires and rims.
- ▷ Fold in exterior mirrors to avoid damage to the exterior mirrors.
- ▷ Deactivate the wiper and, if necessary, rain sensor to avoid damage to the window wiper system.
- ▷ Take off all removable attachments, e.g., antennas.

## Driving into a car wash

#### NOTICE

Selector lever position P is automatically engaged when standby state is switched off. The wheels are blocked. There is a risk of property damage. Do not switch off standby if the vehicle is meant to coast, e.g., in a car wash.

In a tunnel car wash, the vehicle must be able to coast freely. To do so, selector lever position N must be engaged. The parking brake must not be applied.

Some car washes do not permit persons in the vehicle. The vehicle cannot be locked from the outside when in selector lever position N. A signal sounds when an attempt is made to lock the vehicle.

Additional information:

Rolling or pushing the vehicle, refer to page [121](#).

## Driving out of a car wash

When exiting a car wash, make sure that the vehicle key is in the vehicle.

Turn on drive-ready state.

Additional information:

Drive-ready state, refer to page [41](#).

## Lights

When cleaning, do not rub wet lights dry, and do not use abrasive or acidic cleaning agents or cleaning agents containing alcohol. Soak the area soiled by insects with an insect remover and rinse with water. Thaw ice with de-icing spray, do not use an ice scraper.

## After washing the vehicle

After washing the vehicle, apply the brakes briefly to dry them. Otherwise, their braking effect may be reduced. The heat generated

while braking dries the brake disks and brake pads and protects them from corrosion.

Completely remove all wash residue, e.g., smearing, on the window glass to ensure sufficient visibility and to reduce wiper noise and wiper blade wear.

## Vehicle care

### Vehicle care products

#### General information

The manufacturer recommends using care and cleaning products from the vehicle manufacturer. Suitable vehicle care products are available from an authorized service center or another qualified service center or repair shop.

#### Safety information

##### **WARNING**

Cleaning agents can contain substances that are dangerous and harmful to your health. There is a risk of injury and risk of property damage. When cleaning the interior, open the doors or windows. Only use cleaning agents that are intended for cleaning the respective component. Follow the instructions on the packaging.

### Vehicle paintwork

#### General information

Regular vehicle care contributes to driving safety and value retention. Environmental influences in areas with elevated air pollution or natural contaminants can affect the vehicle paintwork. Environmental influences include tree resin or pollen, for example.

To prevent paint alteration and discoloration, remove corrosive substances immediately.

Corrosive substances include spilled fuel, oil, grease, or bird droppings, for example.

#### Matte paintwork

Only use cleaning and care products suitable for vehicles with matte paintwork.

#### Plastic wrap

Use only cleaning and care products that are suitable for vehicles with a plastic wrap.

#### Leather care

Dust and crumbs can work into pores and folds, causing heavy abrasion and premature degradation of the leather surface.

Clean leather regularly with a damp cloth or vacuum cleaner.

Certain clothes and other influences can cause discoloration of the leather. To prevent discoloration, clean and maintain the leather roughly every two months.

Clean light-colored leather more frequently because contamination on such surfaces is substantially more visible.

Use leather care products to preserve the protective coating of the leather.

To prevent leather alteration and discoloration, remove corrosive substances immediately. Corrosive substances include sunscreen, for example.

#### Synthetic leather care

Dust and crumbs can work into pores and folds, causing heavy abrasion and premature degradation of the artificial leather surface.

Clean synthetic leather regularly with a damp microfiber cloth or vacuum cleaner.

In case of major soiling, use a moist soft sponge or microfiber cloth with suitable interior cleaners.

To prevent artificial leather alteration and discoloration, remove corrosive substances

immediately. Corrosive substances include sunscreen, for example.

## Fabric care

### General information

In case of major soiling, use a moist soft sponge or microfiber cloth with suitable interior cleaners.

To prevent material alteration and discoloration, remove corrosive substances immediately. Corrosive substances include sunscreen, for example.

### Safety information

#### NOTICE

Open hook and loop fasteners, zippers, or applications, e.g., studs on clothing can damage the seat covers and the other fabric and leather covers in the vehicle. There is a risk of property damage. Make sure that the fasteners are closed.

### Upholstery material care

Vacuum the cushions regularly with a vacuum cleaner. Clean extensively down to the seams. Avoid rubbing the material vigorously.

### Textile care

Use microfiber cloth soaked with water to clean minor soiling.

### Alcantara

Use microfiber cloth soaked with water to clean minor soiling. Avoid rubbing the material vigorously.

## Caring for special components

### Displays, operating elements, and projection screen of the Head-up display

#### NOTICE

Surfaces can be damaged by improper cleaning, e.g., by using chemical cleaners, or from moisture or liquid of any kind. There is a risk of property damage.

- ▷ Avoid pressure that is too high and do not use any scratching materials.
- ▷ Use a dry, clean antistatic microfiber cloth for cleaning displays.
- ▷ Clean the operating elements and, depending on vehicle equipment, the projection screen of the Head-up display with a damp microfiber cloth and standard household dish soap.

### Light-alloy wheels

Corrosive, acidic, or alkaline cleaning agents can damage the rim surface and the protective layer on adjacent components, e.g., the brakes.

When cleaning the vehicle, use only neutral rim cleaners having a pH value from 5 to 9. Do not use abrasive cleaning agents or steam-jet cleaners above 140°F/60°C. Follow instructions given by the manufacturer.

After cleaning, apply the brakes briefly to dry them. The heat generated while braking dries the brake disks and brake pads and protects them from corrosion.

### Chrome surfaces

Carefully clean chrome-like surfaces, especially if exposed to road salt, using plenty of water and adding auto shampoo as needed.

## Rubber components

Environmental influences can cause surface contamination of rubber parts and a loss of shine. Use only water and suitable cleaning agents for cleaning.

Treat especially worn rubber parts with rubber care products at regular intervals. To avoid damage or noise, use care products containing silicone to maintain the profile seals.

## Wiper blades

The wiper blades are cleaned by using the window washer system.

To prevent a reduction in wiper quality, avoid cleaning the wiper blades manually unless necessary.

## Window

If noise is heard when the windows are opened and closed, e.g. squeaking, proceed as follows:

1. Clean the inside and outside of the windows with a damp cloth and conventional dish soap.
2. While wet, open and close the windows several times so that the window cavity cover also becomes wet.
3. Rub the windows dry.

## Side windows

If there is noise when opening and closing the side windows, e.g., squeaking, clean the inside and outside of the side windows once using a damp cloth and standard dish soap. Then open and close the slightly damp side windows once.

## Fine wood parts

Clean the fine wood veneer and fine wood components with a damp cloth. Then dry with a soft cloth.

## Plastic components

### NOTICE

Solvent cleaners that contain alcohol or solvents such as lacquer thinners, cold cleaning agents, fuel and such, can damage plastic parts. There is a risk of property damage. Clean with a microfiber cloth. Moisten the cloth lightly with water if necessary.

When cleaning plastic parts, make sure that no fabric parts, e.g., the headliner, become wet.

## Carbon parts

For easy cleaning of carbon parts, use a microfiber cloth, water, and silicone-free cleaner to remove everyday soiling.

Corrosive, acidic, or alkaline cleaning agents can alter the surface.

If necessary, have carbon parts removed by an authorized service center or another qualified service center or repair shop.

## Seat belts

### WARNING

Chemical solvent cleaners can destroy the fabric of the seat belts and lead to seat belts no longer having their protective effect. There is a risk of injury and danger to life. Use only a mild soap solution for cleaning the seat belts.

The seat belts should be cleaned for safety reasons. Dirty belt straps impede the reeling action and thus should be avoided for safety reasons.

Use only a mild soap solution for cleaning the installed belt straps.

Seat belts should only be allowed to retract if they are dry.

## Carpets and floor mats

### WARNING

Objects in the driver's footwell can limit the pedal travel or block a depressed pedal.

There is a risk of accident, injury, and property damage.

- ▷ Stow objects in the vehicle such that they are secured and cannot enter into the driver's footwell.
- ▷ Use (carpet) floor mats that are suitable for the vehicle and can be securely attached to the floor.
- ▷ Do not use loose floor mats, and do not layer multiple floor mats on top of one another.
- ▷ Make sure that there is sufficient clearance for the pedals.
- ▷ Make sure that floor mats are securely reattached after removing them, e.g., when cleaning.

The floor mats can be removed from the interior for cleaning.

If the carpets are heavily soiled, clean them with a microfiber cloth and water or a fabric cleaner. Rub back and forth in the direction of travel to prevent the carpet from becoming matted.

## Sensors and camera lenses

### General information

To clean the sensors or camera lens, use a cloth that has been wetted with a small amount of glass cleaner.

### Cleaning the Rear View Camera

When the drive-ready state is switched on, if soiling is detected, the control display will rec-

ommend cleaning the Rear View Camera, or this option can be activated manually.

1. Go through the menu as follows: Apps menu / "Vehicle" / "Parking" / "More" / "Camera cleaning".
2. Select the desired setting.



# Technical data

## Vehicle features and options

This chapter describes model-specific equipment, systems, and functions that are currently available, or may become available in the future, even if they are not present in the vehicle.

Additional information:

Vehicle equipment, refer to page 8.

## General information

The technical data and specifications in the Owner's Manual are used as guidance values. Vehicle-specific data may deviate from this,

for instance due to the optional equipment chosen, national-market version, or country-specific measuring process. More specific values can be obtained in approval documents, on the vehicle info label, or from an authorized service center or another qualified service center or repair shop.

## Dimensions

The dimensions can vary depending on the model version, equipment version or country-specific measurement procedure.

The height of the vehicle can also differ, e.g., due to tires and vehicle load.

## Detailed technical data

### BMW 2 Series Gran Coupe

#### Dimensions

Width with mirrors	in	81.5
	mm	2,070
Width without mirrors	in	70.9
	mm	1,800
Height	in	56.9
	mm	1,445
Length	in	179.2
	mm	4,551
Wheelbase	in	105.1
	mm	2,670
Turning circle Ø	ft	38.4
	m	11.7

**BMW 2 Series Gran Coupe****Dimensions**

Fuel tank, approx.	US gal	12.9
	Liters	49

**BMW 228 Gran Coupe****Weight**

Maximum permissible payload	lb	981
	kg	445
Maximum permissible total weight	lb	4,420
	kg	2,005
Maximum permissible front axle load	lb	2,458
	kg	1,115
Maximum permissible rear axle load	lb	2,238
	kg	1,015

**BMW 228 xDrive Gran Coupe****Weight**

Maximum permissible payload	lb	990
	kg	449
Maximum permissible total weight	lb	4,575
	kg	2,075
Maximum permissible front axle load	lb	2,491
	kg	1,130
Maximum permissible rear axle load	lb	2,326
	kg	1,055

**BMW M235 xDrive Gran Coupe**

**Weight**

Maximum permissible payload	lb	1,085
	kg	492
Maximum permissible total weight	lb	4,696
	kg	2,130
Maximum permissible front axle load	lb	2,458
	kg	1,115
Maximum permissible rear axle load	lb	2,436
	kg	1,105

# Appendix

## General information

---

Any updates to the Owner's Manual of the vehicle are listed here.

# Everything from A to Z

## Index

### 0-9

- 3D view [246](#)
- 48-volt technology, see Mild Hybrid technology [363](#)

### A

- ABS, see Antilock Braking System [208](#)
- Acceleration Assistant, see Launch Control [124](#)
- Acceleration sensor, see G-Meter [148](#)
- Accessories and parts [10](#)
- Accident prevention, see Active Protection [204](#)
- Activated carbon filter, see Interior filter [277](#)
- Activation points, panorama view [248](#)
- Activation word [51](#)
- Active Blind Spot Detection [186](#)
- Active Cruise Control, see Speed control systems [215](#)
- Active damping control, see Adaptive M suspension [269](#)
- Active Guard, see Collision warning systems [168](#)
- Active Park Distance Control [253](#)
- Active Park Distance Control with Side Protection, see Automatic camera perspective [245](#)
- Active Protection [204](#)
- Adaptive M suspension [269](#)
- Adding engine oil types [353](#)
- Additional camera views [242](#)
- Additives, engine oil types [353](#)
- Adjusting speed to route [236](#)
- Advanced Real Time Traffic Information, see Owner's Manual for Navigation, Entertainment, Communication [6](#)
- After run of fan, see Exhaust gas particulate filter [303](#)
- Airbags [164](#)
- Airbags, warning light [166](#)
- Air circulation, see Recirculated-air mode [274](#)
- Air conditioning, climate [273](#)
- Air conditioning system [270](#)
- Air distribution, manual [273](#)
- Air drying, see air conditioning [273](#)
- Air flow, air conditioning system [273](#)
- Air outlets, see Ventilation [277](#)
- Air pressure, tires [316](#)
- Air quality [277](#)
- Air vent, see Ventilation [277](#)
- Alarm, avoiding [88](#)
- Alarm system [87](#)
- All-season tires, see Winter tires [324](#)
- All-season tires, tread, see Tire tread depth [322](#)
- All-wheel drive, see BMW xDrive [211](#)
- Amazon Alexa Car Integration [53](#)
- Ambient light [159](#)
- Android Auto, see Owner's Manual for Navigation, Entertainment, Communication [6](#)
- Antifreeze, see Washer fluid [355](#)
- Antilock Braking System [208](#)
- Anti-theft protection, lug bolt lock [344](#)
- Anti-trap mechanism, glass sunroof [94](#)
- Anti-trap mechanism, windows [91](#)
- Apple CarPlay, see Owner's Manual for Navigation, Entertainment, Communication [6](#)
- Applications, see Owner's Manual for Navigation, Entertainment, Communication [6](#)
- Apps, see Owner's Manual for Navigation, Entertainment, Communication [6](#)
- Assistance with breakdown [364](#)
- Assistance with driving off on inclines, see Drive-off Assistant [127](#)
- Assisted Driving Mode, lane keeping, see Speed control systems [215](#)
- Assisted Driving Mode Plus, see Speed control systems [215](#)
- Assisted View [147](#)
- Audio player, see Owner's Manual for Navigation, Entertainment, Communication [6](#)

- Audio, see Owner's Manual for Navigation, Entertainment and Communication [6](#)
- AUTO H, see Automatic Hold [129](#)
- Automatic camera perspective [245](#)
- Automatic car wash, see Washing the vehicle [371](#)
- Automatic control, headlight [155](#)
- Automatic Curb Monitor, exterior mirror [106](#)
- Automatic deactivation, front-seat passenger airbags [166](#)
- Automatic dimming, see High Beam Assistant [152](#)
- Automatic headlight control [155](#)
- Automatic Hold [129](#)
- Automatic locking [86](#)
- Automatic Parking Assistant [255](#)
- Automatic Parking Assistant Professional [255](#)
- Automatic Parking Assistant, see Maneuver Assistant [261](#)
- Automatic transmission [120](#)
- Automatic unlocking [86](#)
- Automatic wiper system, see Rain sensor [161](#)
- AUTO program, climate control [271](#)
- Auto Start/Stop function [117](#)
- Average consumption, see Trip data [146](#)
- ## B
- Backrest curvature, see Lumbar support [99](#)
- Backrest, seats [96](#)
- Backrest tilt [98](#)
- Back Up Assistant [265](#)
- Bandages, see First-aid kit [364](#)
- Bar for tow-starting/towing [369](#)
- Battery, disposal [363](#)
- Battery, vehicle [361](#)
- Being towed, see Tow-starting and towing [367](#)
- Belts, see Seat belts [100](#)
- Beverage holder, front [292](#)
- Beverage holder, rear [293](#)
- Blind spot collision warning [186](#)
- Blocking, power window, see Safety switch [91](#)
- Blower, see Air flow [273](#)
- Bluetooth audio, see Owner's Manual for Navigation, Entertainment, Communication [6](#)
- Bluetooth connection, see Owner's Manual for Navigation, Entertainment, Communication [6](#)
- BMW app, see Owner's Manual for Navigation, Entertainment, Communication [6](#)
- BMW Assist, see Owner's Manual for Navigation, Entertainment and Communication [6](#)
- BMW ConnectedDrive Upgrades, see Owner's Manual for Navigation, Entertainment, and Communication [6](#)
- BMW Curved Display [44](#)
- BMW Digital Key [73](#)
- BMW Drive Recorder [201](#)
- BMW IconicSounds [269](#)
- BMW ID [61](#)
- BMW iDrive [43](#)
- BMW Intelligent Personal Assistant [50](#)
- BMW Live Cockpit Plus, see BMW Curved Display [44](#)
- BMW Live Cockpit Professional, see BMW Curved Display [44](#)
- BMW maintenance system, see Maintenance system [357](#)
- BMW Operating System, see BMW iDrive [43](#)
- BMW xDrive [211](#)
- Boost, see Sport Boost function [125](#)
- Bottle holder, front, see Cup holder, front [292](#)
- Bottle holder, rear, see Cup holder, rear [293](#)
- Brake assistant [208](#)
- Brake disks, see Brake system [302](#)
- Brake pads, see Brake system [302](#)
- Brake system [302](#)
- Braking, information [304](#)
- Breakdown assistance [364](#)
- Break-in [302](#)
- Break-in procedures [302](#)
- Break recommendation, see Fatigue Alert [205](#)
- Brightness, control display [49](#)
- Bulbs and lights [361](#)
- Button, central locking system [85](#)
- Buttons on the steering wheel [30](#)
- Button, SOS, see Intelligent emergency call [364](#)
- Button, Start/Stop, see Start/Stop button [117](#)
- Bypassing, see Jump-starting [366](#)

C

- Cable for tow-starting/towing [369](#)
- Calibration of the front seats [100](#)
- California Proposition 65 Warning [10](#)
- Camera behind windshield, see Cameras [34](#)
- Camera cleaning, see Sensors and camera lenses [376](#)
- Camera, instrument cluster, see Driver Attention Camera [206](#)
- Camera, interior mirror, see Interior camera [288](#)
- Camera lenses, care [376](#)
- Camera perspective, automatic [245](#)
- Camera perspective, semi-automatic [245](#)
- Camera, Rear View Camera [244](#)
- Cameras [34](#)
- Camera view aid lines, see Additional views [242](#)
- Car battery, see Vehicle battery [361](#)
- Care [371](#)
- Care, displays, screens [374](#)
- Care, Head-up display [374](#)
- Care, light-alloy wheels [374](#)
- Care, vehicle [373](#)
- Cargo area [295](#)
- Cargo area, enlarging [298](#)
- Cargo, see Loading [295](#)
- Car key, see Vehicle key [68](#)
- Carpet, care [376](#)
- Car seats, see Transporting children safely [110](#)
- Car washes, automatic [371](#)
- Car wash, see Washing the vehicle [371](#)
- Car wash view [247](#)
- Catalytic converter, see Hot exhaust system [303](#)
- CBS, see Condition Based Service [357](#)
- Cell phone, see Owner's Manual for Navigation, Entertainment and Communication [6](#)
- Center armrest, front [292](#)
- Center armrest, rear [292](#)
- Center console [32](#)
- Central display area, instrument cluster [145](#)
- Central Information Display (CID), see Control display [46](#)
- Central locking switch, see Central locking system [85](#)
- Central locking system [85](#)
- Central screen, see Control display [46](#)
- Changes, technical, see For your own safety [9](#)
- Change, wheels and tires [323](#)
- Changing parts [360](#)
- Changing wheels [342](#)
- Charging a smartphone, see Wireless charging tray [286](#)
- Charging cradle [286](#)
- Charging tray for smartphones, see Wireless charging tray [286](#)
- Chassis number, see Vehicle identification number [14](#)
- Check Control [134](#)
- Checking the engine oil level, electronic [352](#)
- Checking the oil level, electronic [352](#)
- Children, seating position [110](#)
- Children, transporting safely [110](#)
- Child restraint seats [110](#)
- Child restraint system LATCH [113](#)
- Child restraint systems, mounting [111](#)
- Child restraint systems, see Transporting children safely [110](#)
- Child safety lock, see Securing rear doors and windows [115](#)
- Child seat installation [111](#)
- Child seat, mounting [111](#)
- Child seats, see Transporting children safely [110](#)
- Chrome-plated surfaces, care [374](#)
- Chrome surfaces, care [374](#)
- Cleaning, see Vehicle care [373](#)
- Closing with the smartphone, see BMW Digital Key [73](#)
- Clothes hooks [293](#)
- Coasting [308](#)
- Coasting with idling engine [308](#)
- Coat hooks [293](#)
- Collision warning systems [168](#)
- Comfort Access, see Comfort Access [77](#)
- Comfort entry [100](#)
- Comfort exit [100](#)
- Communication, see Owner's Manual for Navigation, Entertainment and Communication [6](#)

- Compact wheel, see Emergency wheel [342](#)  
Comparison of entries, see Entry comparison [43](#)  
Compound brake [208](#)  
Compressor [338](#)  
Condensation water under the parked vehicle [306](#)  
Condensation, windshield, see Defroster [275](#)  
Condition Based Service [357](#)  
Confirmation signals [86](#)  
ConnectedDrive, see Owner's Manual for Navigation, Entertainment and Communication [6](#)  
Connecting mobile devices to the vehicle [54](#)  
Connection, electrical devices, see Sockets [284](#)  
Consumption, see Trip data [146](#)  
Contactless operation of the trunk lid [83](#)  
Contacts, see Owner's Manual for Navigation, Entertainment, Communication [6](#)  
Continuing driving with flat tire, see Flat tire monitor [335](#)  
Continuing driving with flat tire, see Tire Pressure Monitor [328](#)  
Control by voice, see BMW Intelligent Personal Assistant [50](#)  
Control display [46](#)  
Control systems, driving stability [208](#)  
Convoy Assistant, Assisted Driving Mode Plus, see Speed control systems [215](#)  
Coolant [354](#)  
Coolant level [355](#)  
Coolant temperature, see Engine temperature [144](#)  
Cooling, maximum [274](#)  
Cooling system [354](#)  
Corrosion, brake disks [306](#)  
Cosmetic mirror [284](#)  
Cross Traffic Warning [199](#)  
Cruise Control, Cruise Control, see Speed control systems [215](#)  
Cruise Control, see Speed control systems [215](#)  
Cup holder, front [292](#)  
Cup holder, rear [293](#)  
Current driving condition [149](#)  
Current system software, see Version history [57](#)  
Curved Display [44](#)
- ## D
- Damage, tires [322](#)  
Damping control, active, see Adaptive M suspension [269](#)  
Dashboard [30](#)  
Dashboard, see Instrument cluster [44](#)  
Dash cam, see BMW Drive Recorder [201](#)  
Data memory [11](#)  
Data protection, settings [60](#)  
Data, see Personal data, deleting [60](#)  
Data, technical [378](#)  
Date, see Date and time [148](#)  
Daytime driving lights [157](#)  
Daytime running lights [157](#)  
Deep sleep mode [40](#)  
Defrost [275](#)  
Defrosting the windscreen, see Defroster [275](#)  
Defrosting the windshield, see Defroster [275](#)  
Defrosting windows, see Defroster [275](#)  
Defrosting, windshield, see Defroster [275](#)  
Deleting, personal data [60](#)  
Departure schedule, see Pre-ventilation [278](#)  
Departure time, pre-conditioning via Remote Engine Start [280](#)  
Departure time, pre-ventilation [278](#)  
Destination input [6](#)  
Diagnostic port [358](#)  
Diagnostic socket [358](#)  
Digital Key [73](#)  
Digital key, see BMW Digital Key [73](#)  
Dimmable interior mirror [107](#)  
Dimming exterior mirror [106](#)  
Direct access [50](#)  
Direct access buttons [50](#)  
Direct dial buttons, see Shortcuts [48](#)  
Display and operating concept, see BMW iDrive [43](#)  
Display, BMW iDrive [43](#)  
Displaying information on parking assistance, see Assisted View [147](#)  
Display lighting, see Instrument lighting [158](#)  
Display panel, see Instrument cluster [44](#)  
Displays [132](#)

Displays and icons [8](#)  
 Displays for the vehicle, see Live Vehicle [132](#)  
 Disposal, coolant [355](#)  
 Disposal, vehicle battery [363](#)  
 Distance Control, see Speed control systems [215](#)  
 Distance, see Speed control systems [215](#)  
 Distance Warning, see Park Distance Control [250](#)  
 Door handle lighting, see Welcome lights [156](#)  
 Door opening angle [249](#)  
 Downhill control, see Hill Descent Control [211](#)  
 Drive mode, see My Modes [126](#)  
 Drive-off Assistant [127](#)  
 Drive-Off Monitoring [254](#)  
 Drive-off support [211](#)  
 Drive power reduced [142](#)  
 Driver activity, see Driver Attention Camera [206](#)  
 Driver Assistance, parking, see Parking assistance systems [239](#)  
 Driver assistance systems [213](#)  
 Driver Attention Camera [206](#)  
 Drive-ready state, see Operating state of vehicle [39](#)  
 Drive Recorder [201](#)  
 Driver profiles [61](#)  
 Driver profiles, welcome screen [61](#)  
 Drive sound, see BMW IconicSounds [269](#)  
 Driving [117](#)  
 Driving Assistant, see Collision warning systems [168](#)  
 Driving comfort [269](#)  
 Driving condition, display [149](#)  
 Driving dynamics, setting [210](#)  
 Driving Experience Control, see My Modes [126](#)  
 Driving notes [302](#)  
 Driving off, see Drive-off support [211](#)  
 Driving stability control systems [208](#)  
 Driving through flood [304](#)  
 Driving through water [304](#)  
 Driving tips, see General driving notes [303](#)  
 DSC, see Dynamic Stability Control [208](#)  
 DTC, see Setting for increased driving dynamics [210](#)

Dynamic damping, see Adaptive M suspension [269](#)  
 Dynamic Stability Control [208](#)  
 Dynamic Traction Control, see Setting for increased driving dynamics [210](#)

## E

EDR, see Event data recorder [14](#)  
 Efficiency Coach, Efficient mode [310](#)  
 Efficient drive mode [309](#)  
 Efficient Mode [309](#)  
 Efficient Mode, see My Modes [126](#)  
 Efficient rolling, see Current driving condition [149](#)  
 Electric range [143](#)  
 Electromechanical parking brake [127](#)  
 Electronic oil measurement [352](#)  
 Electronic stability program, see Dynamic Stability Control [208](#)  
 Emergency brake, see Emergency Stop Assistant [197](#)  
 Emergency braking, see PostCrash iBrake [205](#)  
 Emergency call [364](#)  
 Emergency cargo area release [85](#)  
 Emergency release, fuel filler flap [315](#)  
 Emergency release, parking lock [123](#)  
 Emergency Stop Assistant [197](#)  
 Emergency unlocking, trunk lid [85](#)  
 Emergency wheel [342](#)  
 Emissions, see Pollutant emissions [358](#)  
 Energy savings, see Gear shift indicator [141](#)  
 Engine, Auto Start/Stop function [117](#)  
 Engine compartment [347](#)  
 Engine coolant [354](#)  
 Engine idling when driving, see Coasting [308](#)  
 Engine oil filler neck [352](#)  
 Engine oil, refilling [352](#)  
 Engine oil types to add [353](#)  
 Engine sound, see BMW IconicSounds [269](#)  
 Engine starting, see Vehicle operating state [39](#)  
 Engine start, see Jump-starting [366](#)  
 Engine temperature [144](#)  
 Entering a destination, see Owner's Manual for Navigation, Entertainment, Communication [6](#)

- Entering an address, navigation, see Owner's Manual for Navigation, Entertainment and Communication [6](#)
- Entertainment, see Owner's Manual for Navigation, Entertainment and Communication [6](#)
- Entertainment, selection list in the instrument cluster [141](#)
- Entry assistance, exit assistance [100](#)
- Entry comparison [43](#)
- Error indicators, see Check Control [134](#)
- eSIM telephony, see Owner's Manual for Navigation, Entertainment, Communication [6](#)
- ESP, see Dynamic Stability Control [208](#)
- Evasion Assistant, see Forward Collision Mitigation [169](#)
- Event data recorder [14](#)
- Exchange, wheels and tires [323](#)
- Exhaust emissions, see Pollutant emissions [358](#)
- Exhaust gas particulate filter [303](#)
- Exhaust, see Exhaust system [303](#)
- Exhaust system [303](#)
- Exit Warning [181](#)
- Exterior lighting, locked vehicle, see Welcome light [157](#)
- Exterior mirror [105](#)
- Exterior mirror, Automatic Curb Monitor [106](#)
- Exterior mirror cameras, see Cameras [34](#)
- External start, see Jump-starting [366](#)
- Eye for towing [369](#)
- F**
- Factory settings, see Vehicle data, resetting [60](#)
- Failure message, see Check Control [134](#)
- Fan after run, see Exhaust gas particulate filter [303](#)
- Fastening seat belts, see Seat belts [100](#)
- Fatigue Alert [205](#)
- Fatigue Alert, see Driver Attention Camera [206](#)
- Fatigue warner, see Fatigue Alert [205](#)
- Fault indicators, see Check Control [134](#)
- Filler neck for engine oil [352](#)
- Filling pressure, tires [316](#)
- Filter, see Interior filter [277](#)
- Fine wood parts, care [375](#)
- First-aid kit [364](#)
- Flat tire, changing wheels [342](#)
- Flat tire, continuing driving, see Flat tire monitor [335](#)
- Flat tire, continuing driving, see Tire Pressure Monitor [328](#)
- Flat tire monitor [335](#)
- Flat tire notification, see Flat tire monitor [335](#)
- Flat tire notification, see Tire Pressure Monitor [328](#)
- Flat tire, repairing [338](#)
- Flat tire, see Flat tire monitor [335](#)
- Flat tire, see Tire Pressure Monitor [328](#)
- Flat tire warning light, see Flat tire monitor [335](#)
- Flat tire warning light, see Tire Pressure Monitor [328](#)
- Floor carpet, care [376](#)
- Floor mats, care [376](#)
- Fold-away position, wiper [162](#)
- Fold-out position [162](#)
- Foot brake, see Braking safely [304](#)
- Forward Collision Mitigation [169](#)
- Forward Collision Warning, see Forward Collision Mitigation [169](#)
- For your own safety [9](#)
- Front airbags [164](#)
- Front camera, see Cameras [34](#)
- Front lights, replacing, see Bulbs and lights [361](#)
- Front passenger's side exterior mirror, tilting down, see Automatic Curb Monitor [106](#)
- Front passenger airbags, automatic deactivation [166](#)
- Front radar sensor, see Radar sensors [35](#)
- Front-seat passenger airbag, indicator light [167](#)
- Front seats [96](#)
- Fuel [350](#)
- Fuel filler cap [314](#)
- Fuel filler flap [314](#)
- Fuel gauge [144](#)
- Fuel quality [350](#)
- Fuel recommendation [350](#)
- Fuses [363](#)

## G

- Garage door opener, see Integrated Universal Remote Control [282](#)
- Gasoline [350](#)
- Gasoline particulate filter, see Exhaust gas particulate filter [303](#)
- Gasoline particulate filter, see Exhaust particulate filter [303](#)
- Gasoline quality [351](#)
- Gear change, see Automatic transmission [120](#)
- Gearshift indicator [141](#)
- General driving notes [303](#)
- Glare shield, see Sun visor [284](#)
- Glass sunroof [92](#)
- Glass sunroof, initializing the glass sunroof and sun protection [95](#)
- Glove compartment [291](#)
- G-Meter [148](#)
- GPS navigation, navigation, see Owner's Manual for Navigation, Entertainment, Communication [6](#)
- Guest profile, see BMW ID [61](#)

## H

- Handbrake, see Parking brake [127](#)
- Hand-held transmitter, alternating code [283](#)
- Hands-free device, see Owner's Manual for Navigation, Entertainment, Communication [6](#)
- Hands-free system [6](#)
- Hazard warning system [364](#)
- HDC, see Hill Descent Control [211](#)
- Head airbag [165](#)
- Headlight control, automatic [155](#)
- Headlight flasher [151](#)
- Headlight glass [361](#)
- Headlights, care [372](#)
- Headlights, replacing, see Bulbs and lights [361](#)
- Headlights, turning up, dimming, see High Beam Assistant [152](#)
- Headliner [33](#)
- Head restraints and seats [96](#)
- Head restraints, front [103](#)
- Head restraints, rear [104](#)
- Head-up display [132](#)

- Head-up display, care [374](#)
- Head-up display, store position, see Memory function [108](#)
- Heated steering wheel [276](#)
- Heavy cargo, stowing [296](#)
- High Beam Assistant [152](#)
- High-beam headlights [151](#)
- Higher speed range [303](#)
- Highway Assistant, Assisted Driving Mode Plus, see Speed control systems [215](#)
- Hill Ascent Control, see Drive-off Assistant [127](#)
- Hill Descent Control [211](#)
- Hills [305](#)
- HomeLink, see Integrated Universal Remote Control [282](#)
- Homepage, see Internet [8](#)
- Hood [347](#)
- Horn [30](#)
- Hot exhaust system [303](#)

## I

- iBrake PostCrash [205](#)
- Ice warning, see Outside temperature [145](#)
- IconicSounds [269](#)
- Icons and displays [8](#)
- Identification marks, tires [320](#)
- Identification number, see Vehicle identification number [14](#)
- Idle state, see Operating state of vehicle [39](#)
- iDrive [43](#)
- Inclination [98](#)
- Indicator light, front-seat passenger airbag [167](#)
- Indicator lights [135](#)
- Individual air distribution [273](#)
- Individual settings, see BMW ID [61](#)
- Inductive charging, smartphone, see Wireless charging tray [286](#)
- Information [6](#)
- Information on Driver Assistance, displaying, see Assisted View [147](#)
- Input, BMW iDrive [43](#)
- Inserts, see Supplementary documentation [7](#)
- Installation of child restraint systems [111](#)
- Instrument cluster [44](#)
- Instrument lighting [158](#)

Instrument panel, see Instrument cluster [44](#)  
Integrated key [70](#)

Integrated Owner's Manual in the vehicle [7](#)

Integrated Universal Remote Control [282](#)

Intelligent emergency call [364](#)

Intelligent Personal Assistant [50](#)

Intelligent Safety, see Collision warning systems [168](#)

Intended use [9](#)

Interior camera [288](#)

Interior equipment [282](#)

Interior filter [277](#)

Interior light, locked vehicle, see Welcome light [157](#)

Interior lights [158](#)

Interior mirror, automatic dimming feature [107](#)

Interior mirror, manually dimmable [107](#)

Interior motion sensor [88](#)

Internet page [8](#)

Intersection Warning, see Forward Collision Mitigation [169](#)

Interval indicator, see Service notifications [150](#)

## J

Jacking points [345](#)

Jacking points for the vehicle jack [345](#)

Joystick, see Automatic transmission [120](#)

Jump-starting [366](#)

Jump-starting terminals [366](#)

Jump-start terminals [366](#)

## K

Key Card, see Service Card [76](#)

Key, mechanical [70](#)

Key, see Vehicle key [68](#)

Kickdown, see Automatic transmission [120](#)

Knee airbag [165](#)

## L

Labeling [320](#)

Lane boundary, warning [183](#)

Lane Change Assistant [229](#)

Lane change with active destination guidance [231](#)

Lane control assistant with active side collision mitigation, see Side Collision Protection [189](#)

Lane Departure Warning [183](#)

Lane keeping, Assisted Driving Mode, see Speed control systems [215](#)

Lane lines, additional camera view displays [242](#)

Lane threshold, warning [183](#)

LATCH child restraint system [113](#)

Launch Control [124](#)

Leather care [373](#)

LED headlights, changing, see Bulbs and lights [361](#)

Left Turn Warning, see Forward Collision Mitigation [169](#)

Letters and numbers, entering [43](#)

Light-alloy wheels, care [374](#)

Light in exterior mirror, see Active Blind Spot Detection [186](#)

Light in exterior mirror, see Cross Traffic Warning [199](#)

Lighting [154](#)

Lighting, speakers [160](#)

Light replacement, see Bulbs and lights [361](#)

Lights [151](#)

Lights, care [372](#)

Light switch, see Exterior lighting [154](#)

List, instrument cluster, see Selection lists [141](#)

Live Cockpit Plus, see BMW Curved Display [44](#)

Live Cockpit Professional, see BMW Curved Display [44](#)

Live Vehicle [132](#)

Load [296](#)

Loading [295](#)

Loading position [298](#)

Loading the cargo area, see Loading [295](#)

Local time, see Time [148](#)

Locking, see Opening and Closing [68](#)

Locking, settings [85](#)

Lock, lug bolts [344](#)

Long stationary periods, see Deep sleep mode [40](#)

Loop, see Towing eye [369](#)

Low-beam headlights [155](#)

Lower back support, see Lumbar support [99](#)  
 Lug bolt lock [344](#)  
 Luggage rack, refer to Roof bars [306](#)  
 Lumbar massage, see Seat massage [99](#)  
 Lumbar support [99](#)  
 Lumbar support and backrest width, M Sport seat [99](#)

## M

Maintenance [357](#)  
 Maintenance recommendation, see Condition Based Service [357](#)  
 Maintenance system [357](#)  
 Make-up mirror [284](#)  
 Malfunction, vehicle key [73](#)  
 Maneuver Assistant [261](#)  
 Manually unlocking doors, see Integrated key [70](#)  
 Manual mode, transmission [123](#)  
 Map, see Owner's Manual for Navigation, Entertainment, Communication [6](#)  
 Map update, see Owner's Manual for Navigation, Entertainment, Communication [6](#)  
 Marking, run-flat tire [325](#)  
 Matte paintwork [373](#)  
 Matt paint, care [373](#)  
 Maximum cooling [274](#)  
 Maximum speed, winter tires [324](#)  
 M Compound brake [208](#)  
 Media recording, see BMW Drive Recorder [201](#)  
 Medical supplies, see First-aid kit [364](#)  
 Memory function [108](#)  
 Messages, see Check Control [134](#)  
 Messages, see Owner's Manual for Navigation, Entertainment, Communication [6](#)  
 Meters, see Instrument cluster [44](#)  
 Microfilter, see Interior filter [277](#)  
 Mild Hybrid technology [363](#)  
 Mileage, real, see Trip data [146](#)  
 Minimum tread depth, tires [322](#)  
 Mobile devices, connecting [54](#)  
 Mobile phone, see Owner's Manual for Navigation, Entertainment and Communication [6](#)  
 Mobility system, see Tire repair set [338](#)  
 MODE button, see Speed control systems [215](#)

Modifications, technical, see For your own safety [9](#)  
 Moisture in headlight, see Headlight glass [361](#)  
 Monitor, see Control display [46](#)  
 Motorsport, see Driving on a race track [306](#)  
 Mounting of child restraint systems [111](#)  
 M suspension, adaptive, see Adaptive M suspension [269](#)  
 Mug holder, front, see Cup holder, front [292](#)  
 Mug holder, rear, see Cup holder, rear [293](#)  
 Multifunction hook [296](#)  
 Multi-function steering wheel [30](#)  
 Multifunction steering wheel, buttons [30](#)  
 My BMW app, see Owner's Manual for Navigation, Entertainment, Communication [6](#)  
 My Modes [126](#)

## N

Neck restraints, front, see Head restraints, front [103](#)  
 Neck restraints, rear, see Head restraints, rear [104](#)  
 Net, cargo area [296](#)  
 Neutral cleaner, light-alloy wheels, see Care [374](#)  
 Notifications, see Owner's Manual for Navigation, Entertainment, Communication [6](#)  
 No Turn on Red Information [196](#)  
 Nylon rope for tow-starting/towing [369](#)

## O

OBD, see Diagnostic socket [358](#)  
 Obstacle marking, additional camera view displays [242](#)  
 Octane number, see Gasoline quality [351](#)  
 Odometer, see Trip data [146](#)  
 OFF indicator, see Standby and drive-ready state [143](#)  
 Oil filler neck [352](#)  
 Oil, refilling [352](#)  
 Oil service interval, see Service notifications [150](#)  
 Oil types to add, engine [353](#)  
 Old battery [363](#)



Pressure warning, see Flat tire monitor [335](#)  
 Pressure warning, see Tire Pressure Monitor [328](#)  
 Pre-ventilation [278](#)  
 Prevention of rear-end collision, see Rear-End Collision Preparation [191](#)  
 Primary user, see BMW ID [62](#)  
 Protective function, glass sunroof, see Anti-trap mechanism [94](#)  
 Protective function, windows, see Anti-trap mechanism [91](#)

## R

Race track [306](#)  
 Radar sensors [35](#)  
 Radiator fan, see Exhaust gas particulate filter [303](#)  
 Radiator fluid [354](#)  
 Radio information, see Owner's Manual for Navigation, Entertainment, Communication [6](#)  
 Radio, see Owner's Manual for Navigation, Entertainment and Communication [6](#)  
 Radio stations, see Owner's Manual for Navigation, Entertainment, Communication [6](#)  
 Rain sensor [161](#)  
 Rain sensor mode [161](#)  
 Range [143](#)  
 READY indicator, see Standby and drive-ready state [143](#)  
 Rear climate control, see Climate control [270](#)  
 Rear-End Collision Preparation [191](#)  
 Rear light, replacing, see Bulbs and lights [361](#)  
 Rear Occupant Alert [102](#)  
 Rear seat backrests, folding down [298](#)  
 Rear View Camera [244](#)  
 Rear View Camera, see Cameras [34](#)  
 Rear-view mirror, exterior [105](#)  
 Rear window defroster [275](#)  
 Recirculated-air mode [274](#)  
 Recirculating air filter, see Interior filter [277](#)  
 Recommended gear, see Gearshift indicator [141](#)  
 Recommended tire brands [324](#)  
 Reduced drive power [142](#)  
 Refueling [314](#)

Release fuel filler flap, manual [315](#)  
 Releasing the parking lock, electronically [123](#)  
 Remaining range, see Range [143](#)  
 Remote 3D View [249](#)  
 Remote control, see Remote Control Parking [264](#)  
 Remote control, see Vehicle key [68](#)  
 Remote control, universal [282](#)  
 Remote Engine Start, see Pre-conditioning [279](#)  
 Remote parking [264](#)  
 Remote services, see Owner's Manual for Navigation, Entertainment, Communication [6](#)  
 Remote Software Upgrade [56](#)  
 Renewal, wheels and tires [323](#)  
 Replacement, wheels and tires [323](#)  
 Replacing bulbs, see Bulbs and lights [361](#)  
 Replacing light-emitting diodes, see Bulbs and lights [361](#)  
 Replacing parts [360](#)  
 Replacing the battery, vehicle key [69](#)  
 Reporting safety defects [15](#)  
 Reserve warning, see Fuel gauge [144](#)  
 Reserve warning, see Range [143](#)  
 Reservoir, washer fluid [355](#)  
 Resetting, vehicle data [60](#)  
 Reset, Tire Pressure Monitor [330](#)  
 Reset, vehicle settings [60](#)  
 Restricted Driving, see BMW Digital Key [73](#)  
 Retreaded tires [324](#)  
 Reversing Assistant [265](#)  
 Reversing Assistant Professional [265](#)  
 Risk of collision when exiting, see Exit Warning [181](#)  
 Roadside parking lights [156](#)  
 Rollback Prevention, see Drive-off Assistant [127](#)  
 Rolling code hand-held transmitter [283](#)  
 Rolling to a stop with engine decoupled, see Coasting [308](#)  
 RON, see gasoline quality [351](#)  
 Roof bars [306](#)  
 Roofliner [33](#)  
 Roof luggage rack, refer to Roof bars [306](#)  
 Rope for tow-starting/towing [369](#)  
 Route and Intersection Assistant, see Adjusting speed to route [236](#)

- Route, navigation, see Owner's Manual for Navigation, Entertainment, Communication [6](#)
- RSC, see Runflat tires [325](#)
- Rubber components, care [375](#)
- Runflat tires [325](#)
- Runflat tires, see Runflat tires [325](#)
- ## S
- Safe braking [304](#)
- Safe Exit, see Exit Warning [181](#)
- Safe Share function, see BMW Digital Key [73](#)
- Safety [164](#)
- Safety and warning, see Collision warning systems [168](#)
- Safety package, see Active Protection [204](#)
- Safety switch, windows [91](#)
- Safety systems, see Airbags [164](#)
- Safety systems, see Collision warning systems [168](#)
- Satellite radio, see Owner's Manual for Navigation, Entertainment, Communication [6](#)
- Saved stations, see Owner's Manual for Navigation, Entertainment, Communication [6](#)
- Saving fuel [308](#)
- Screen, see BMW Curved Display [44](#)
- Screen, see Control display [46](#)
- Sealant, see Tire repair set [338](#)
- Seamless mode change, see Remote Control Parking [264](#)
- Seat belt reminder, see Seat belt warning [102](#)
- Seat belts [100](#)
- Seat belts, care [375](#)
- Seat belt warning [102](#)
- Seat calibration [100](#)
- Seat heating [276](#)
- Seating position for children [110](#)
- Seat massage [99](#)
- Seat Occupancy Alert [102](#)
- Seats and head restraints [96](#)
- Seats, front [96](#)
- Securing, cargo [296](#)
- Securing, doors and windows [115](#)
- Securing vehicle to prevent rolling away, see Parking brake [127](#)
- Selection list on the instrument cluster [141](#)
- Selector lever, see Automatic transmission [120](#)
- Semi-automatic camera perspective [245](#)
- Semi-slick, see Track tires [326](#)
- Sensors, care [376](#)
- Service and warranty [11](#)
- Service Card [76](#)
- Service notifications [150](#)
- Service notifications, see Condition Based Service [357](#)
- Servotronic [212](#)
- SET button, see Speed control systems [215](#)
- Setting driving dynamics, see My Modes [126](#)
- Setting the language, see Setting the system language [52](#)
- Setting the system language [52](#)
- Setting the time [148](#)
- Setting units of measurement [148](#)
- Shift lights [145](#)
- Shift paddles on the steering wheel [123](#)
- Shift point indicator, tachometer [145](#)
- Shortcuts, iDrive [48](#)
- Side airbag [164](#)
- Side Collision Protection [189](#)
- Side protection, see Automatic camera perspective [245](#)
- Side view [246](#)
- Signaling, horn [30](#)
- Sitting safely [96](#)
- Slipperiness, see Outside temperature [145](#)
- Slippery road, see Outside temperature [145](#)
- Smartphone, see Owner's Manual for Navigation, Entertainment and Communication [6](#)
- Smartphone, using via voice control [53](#)
- Snapshot camera, see Interior camera [288](#)
- Snow chains [327](#)
- Socket for on-board diagnosis, see Diagnostic socket [358](#)
- Sockets, electrical devices [284](#)
- Software Update, see Remote Software Upgrade [56](#)
- Software Upgrade, see Remote Software Upgrade [56](#)
- Soot particulate filter, see Exhaust gas particulate filter [303](#)
- SOS button, see Intelligent emergency call [364](#)

- Sound settings, see Owner's Manual for Navigation, Entertainment, Communication [6](#)
  - Spare tire, see Emergency wheel [342](#)
  - Speaker lighting [160](#)
  - Speed control systems [215](#)
  - Speed Limit Assist [234](#)
  - Speed Limit Assistant [234](#)
  - Speed limit device, speed limiter, see Speed control systems [215](#)
  - Speed limit, display, see Speed Limit Info with no-passing indicator [213](#)
  - Speed limiter, manual, see Speed control systems [215](#)
  - Speed Limit Info with no-passing indicator [213](#)
  - Speed warning [213](#)
  - Sport Boost function [125](#)
  - Sport displays [149](#)
  - Sport Mode, see My Modes [126](#)
  - SPORT PLUS setting, see Setting for increased driving dynamics [210](#)
  - Sport program, see Automatic transmission [120](#)
  - Sport suspension, see Adaptive M suspension [269](#)
  - Stability control systems [208](#)
  - Standard equipment, see Vehicle equipment [8](#)
  - Standby state, see Operating state of vehicle [39](#)
  - Start/Stop, automatic, see Auto Start/Stop function [117](#)
  - Start/Stop button [117](#)
  - Starting aid terminals [366](#)
  - Starting, see Vehicle operating state [39](#)
  - Starting the engine, see Vehicle operating state [39](#)
  - Starting the vehicle, see Start/Stop button [117](#)
  - Stationary periods, see Deep sleep mode [40](#)
  - Stations, see Owner's Manual for Navigation, Entertainment, Communication [6](#)
  - Status control display, tires [330](#)
  - Status information, iDrive [47](#)
  - Status of Owner's Manual [9](#)
  - Status, vehicle [149](#)
  - Steering column adjustment [107](#)
  - Steering support, see Servotronic [212](#)
  - Steering wheel, adjusting [107](#)
  - Steering wheel, buttons [30](#)
  - Steering wheel heating [276](#)
  - Steptronic Sport transmission, see Automatic transmission [120](#)
  - Steptronic transmission, see Automatic transmission [120](#)
  - Steptronic transmission with double clutch, see Automatic transmission [120](#)
  - Storage compartment, cargo area [297](#)
  - Storage compartments [291](#)
  - Storage, tires [325](#)
  - Store Mirror position, see Memory function [108](#)
  - Store seat position, see Memory function [108](#)
  - Store steering wheel position, see Memory function [108](#)
  - Storing the vehicle [358](#)
  - Stowage, cargo [296](#)
  - Summer tires, tread, see Tire tread depth [322](#)
  - Sun visor [284](#)
  - Supplementary documentation [7](#)
  - Supplementary Owner's Manuals, see Supplementary documentation [7](#)
  - Switches, see Dashboard [30](#)
  - Switching off the engine, see Vehicle operating state [39](#)
  - SYNC program, Climate control [275](#)
- ## T
- Tachometer [143](#)
  - Taillights, replacing, see Bulbs and lights [361](#)
  - Taking the vehicle out of service [358](#)
  - Technical changes, see For your own safety [9](#)
  - Technical data [378](#)
  - Telephone, see Owner's Manual for Navigation, Entertainment and Communication [6](#)
  - Telephone, selection list in the instrument cluster [141](#)
  - Teleservices, see Owner's Manual for Navigation, Entertainment, Communication [6](#)
  - Temperature, air conditioning system [272](#)
  - Temperature display, see outside temperature [145](#)
  - Terrain View, see Live Vehicle [132](#)
  - Theft alarm system, see Alarm system [87](#)
  - Thigh support [98](#)

- Tilt alarm sensor [88](#)
  - Tilt, backrest [98](#)
  - Tilting down, front passenger's side exterior mirror, see Automatic Curb Monitor [106](#)
  - Time settings, see Date and time [148](#)
  - Time zone [148](#)
  - Tire brands, recommendation [324](#)
  - Tire change [323](#)
  - Tire damage [322](#)
  - Tire identification marks [320](#)
  - Tire inflation pressure [316](#)
  - Tire marking [320](#)
  - Tire pressure [316](#)
  - Tire Pressure Monitor [328](#)
  - Tire pressure monitoring, see Tire Pressure Monitor [328](#)
  - Tire Pressure Monitor, reset [330](#)
  - Tire Pressure Monitor, see Flat tire monitor [335](#)
  - Tire pressure warning, see Flat tire monitor [335](#)
  - Tire repair set [338](#)
  - Tires and wheels [316](#)
  - Tire sealant, see Tire repair set [338](#)
  - Tire settings [329](#)
  - Tires, run-flat [325](#)
  - Tire tread [322](#)
  - Toggle, see Automatic transmission [120](#)
  - Tools [360](#)
  - Torque display, see Sport displays [149](#)
  - Total range, see Fuel gauge [144](#)
  - Tow bar [369](#)
  - Towing [367](#)
  - Towing eye [369](#)
  - Tow rope [369](#)
  - Tow-starting [367](#)
  - Track tires [326](#)
  - Traction control system, see Dynamic Stability Control [208](#)
  - Traffic bulletins, see Owner's Manual for Navigation, Entertainment, Communication [6](#)
  - Traffic Jam Assistant, Assisted Driving Mode Plus, see Speed control systems [215](#)
  - Traffic Light and Sign Warning [192](#)
  - Transporting children safely [110](#)
  - Tread, tires [322](#)
  - Trip data [146](#)
  - Trip odometer, see Trip data [146](#)
  - Trunk lid, contactless operation [83](#)
  - Trunk lid, emergency unlocking [85](#)
  - Trunk, see Cargo area [295](#)
  - Tunnel car wash [371](#)
  - Turn indicators, see Turn signals [151](#)
  - Turning circle lines, additional camera view displays [242](#)
  - Turning display, see No Turn on Red Information [196](#)
  - Turn signal, indicator light [138](#)
  - Turn signal, replacing bulbs, see Bulbs and lights [361](#)
  - Turn signals [151](#)
  - Turn Warning, see Active Blind Spot Detection [186](#)
- ## U
- Ultrasonic sensors [37](#)
  - Unintended alarm, see Unintentional alarm, avoiding [88](#)
  - Unintentional alarm, avoiding [88](#)
  - Units, see Setting units of measurement [148](#)
  - Universal remote control [282](#)
  - Unlocking, see Opening and Closing [68](#)
  - Unlocking, settings [85](#)
  - Updates made after the editorial deadline [9](#)
  - Upgrade, see Remote Software Upgrade [56](#)
  - Upholstery material care [374](#)
  - Upper retaining strap, top tether [114](#)
  - USB audio, see Owner's Manual for Navigation, Entertainment, Communication [6](#)
  - USB connection [285](#)
  - USB port, position in vehicle [285](#)
  - Used battery, disposing of [363](#)
  - Use, intended [9](#)
  - User, see BMW ID [61](#)
  - Using menus, see BMW iDrive [43](#)
- ## V
- Vanity mirror [284](#)
  - Vehicle battery [361](#)

Vehicle breakdown, see Breakdown assistance [364](#)

Vehicle care [373](#)

Vehicle care products [373](#)

Vehicle data, resetting [60](#)

Vehicle equipment [8](#)

Vehicle identification number [14](#)

Vehicle issues [364](#)

Vehicle key [68](#)

Vehicle key, additional [69](#)

Vehicle key, loss [69](#)

Vehicle paint, care [373](#)

Vehicle paintwork [373](#)

Vehicle rolling away, see Parking brake [127](#)

Vehicle sensors [34](#)

Vehicle starting, see Start/Stop button [117](#)

Vehicle status [149](#)

Vehicle storage [358](#)

Ventilation [277](#)

Ventilation, see Pre-ventilation [278](#)

Venting, see Ventilation [277](#)

Version Software, see Remote Software Upgrade [56](#)

Video recording, see BMW Drive Recorder [201](#)

VIN, see Vehicle identification number [14](#)

Voice activation system [50](#)

Voice activation system, see BMW Intelligent Personal Assistant [50](#)

Voice command, see BMW Intelligent Personal Assistant [50](#)

Voice control [50](#)

Voice control, see BMW Intelligent Personal Assistant [50](#)

Voice recognition [50](#)

Voice recognition, see BMW Intelligent Personal Assistant [50](#)

Volume, see Owner's Manual for Navigation, Entertainment, Communication [6](#)

## W

Wake word [51](#)

Warning for crossing traffic, see Cross Traffic Warning [199](#)

Warning for exiting, see Exit Warning [181](#)

Warning for opening doors, see Exit Warning [181](#)

Warning function for incorrect driving direction, see Wrong Way Warning [195](#)

Warning function for oncoming traffic, see Forward Collision Mitigation [169](#)

Warning function, rear-end collision [191](#)

Warning light in exterior mirror, see Active Blind Spot Detection [186](#)

Warning light in exterior mirror, see Cross Traffic Warning [199](#)

Warning lights [135](#)

Warning messages, see Check Control [134](#)

Warning systems for collision hazards [168](#)

Warning triangle [364](#)

Warranty [9](#)

Warranty Booklet, see Warranty [9](#)

Washer fluid [355](#)

Washer nozzles, windshield [162](#)

Washing the vehicle [371](#)

Washing, vehicle [371](#)

Water on road [304](#)

Water, see Condensation water under the parked vehicle [306](#)

Website, see Internet [8](#)

Welcome lights [156](#)

Welcome screen, driver profiles [61](#)

Welcome window, driver profiles [61](#)

Wheel change [342](#)

Wheels and tires [316](#)

Wheels and tires, exchange [323](#)

Widgets, iDrive [47](#)

Widgets, instrument cluster, see Central display area [145](#)

Wi-Fi connection, see Owner's Manual for Navigation, Entertainment, Communication [6](#)

Windows, powered [89](#)

Windscreen, removing condensation, see Defroster [275](#)

Windshield cleaning system, see Wiper system [160](#)

Windshield, removing condensation, see Defroster [275](#)

Windshield washer fluid, see Washer fluid [355](#)

Windshield washer nozzles [162](#)

Windshield wipers, see Wiper system [160](#)

Winter storage, see Long-term vehicle storage [358](#)  
Winter tires [324](#)  
Winter tires, tread, see Tire tread depth [322](#)  
Wiper blades, replacing [360](#)  
Wiper fluid, see Washer fluid [355](#)  
Wiper, fold-away position [162](#)  
Wipers, see Wiper system [160](#)  
Wiper system [160](#)  
Wireless charging, smartphone, see Wireless charging tray [286](#)  
Wireless charging tray for smartphones [286](#)  
Wood parts, care [375](#)  
Wordmatch principle, see Entry comparison [43](#)  
Wrong Way Warning [195](#)

## X

xDrive [211](#)

## Y

Yield warning [192](#)



01405B73513 ue

# California Proposition 65 Warning

---

For vehicles sold in California:

## **California Proposition 65 Warning**



### **WARNING**

Operating, servicing and maintaining a passenger vehicle or off-highway motor vehicle can expose you to chemicals including engine exhaust, carbon monoxide, phthalates, and lead, which are known to the State of California to cause cancer and birth defects or other reproductive harm. To minimize exposure, avoid breathing exhaust, do not idle the engine except as necessary, service your vehicle in a well-ventilated area and wear gloves or wash your hands frequently when servicing your vehicle. For more information go to [www.P65Warnings.ca.gov/passenger-vehicle](http://www.P65Warnings.ca.gov/passenger-vehicle).

# BMW DRIVER'S GUIDE APP.

YOUR DIGITAL VEHICLE INFORMATION.

The BMW Driver's Guide app explains the equipment of your vehicle and offers further scopes and functions:



All information surrounding navigation, entertainment and communication

Photorealistic animations for various vehicle functions

Keyword search

360° view: Explore your vehicle interactively inside and out

Smart Scan for Apple iPhone: Icon and optical character recognition on the buttons in the vehicle

Available in more than 30 languages

Can be used offline after download

