

Owner's Manual

2024 A8

Foreword

Thank you for choosing an Audi – we value your trust in us.

Your new Audi will allow you to experience the best in groundbreaking technology and premium quality equipment that a vehicle has to offer. Audi recommends that you read your Owner's Manual thoroughly so that you quickly become acquainted with your Audi and make use of all of its features.

In addition to explaining how the different features work, there are many useful tips and information concerning your safety, how to care for your vehicle, and how to maintain your vehicle's value. Audi also gives you useful tips and information on how to drive your vehicle more efficiently and in an environmentally-friendly manner.

Audi hopes you enjoy driving your vehicle and wishes you safe and pleasant motoring.



WARNING

Operating, servicing and maintaining a passenger vehicle or off-highway motor vehicle can expose you to chemicals including engine exhaust, carbon monoxide, phthalates, and lead, which are known to the State of California to cause cancer and birth defects or other reproductive harm. To minimize exposure, avoid breathing exhaust, do not idle the engine except as necessary, service your vehicle in a well-ventilated area and wear gloves or wash your hands frequently when servicing your vehicle. For more information go to www.P65Warnings.ca.gov/passenger-vehicle.

Table of contents

About this Owner's Manual	5	Panoramic glass roof	51
Summary	6	Valet parking	52
Quick access	6	Garage door opener	53
Online information	6	Lights and vision	56
FAQ	7	Exterior lighting	56
Cockpit	9	Interior lighting	60
Indicator lights overview	10	Vision	61
Display and operation	15	Windshield wipers	63
Instrument cluster	15	Digital compass	65
Instrument cluster overview	15	Sitting correctly and safely	67
Operating	16	Maintaining the correct seating position .	67
Adjusting the display	16	Front seats	67
Coolant temperature display	17	Rear seats	71
Tachometer	17	Steering wheel	74
Odometer	17	Head restraints	75
Outside temperature display	18	Safety belts	77
Engine oil temperature indicator	18	Memory function	80
Boost indicator	18	Airbag system	81
Vehicle functions	18	Child safety seats	85
Touch displays	20	Storage and convenience	91
General touch display operation	20	Power sources	91
Multi Media Interface	22	Cup holders	92
Rear Seat Remote	28	Storage and compartments	92
Head-up display	30	Luggage compartment	94
Description	30	Roof rack	95
Voice recognition system	31	Warm and cold	97
General information	31	Climate control system	97
Description	31	Steering wheel heating	101
External voice operation	32	Fluids in the A/C system	102
Global functions	33	Driving	103
Additional function buttons	33	Starting the vehicle	103
Starting and driving	34	When driving	104
Personalization	34	Drive system	109
Users	34	Start/Stop system	110
Opening and closing	37	Brakes	112
Central locking	37	Electromechanical parking brake	114
Keys	42	Special driving situations	115
Luggage compartment lid	45	Driving dynamic	117
Child safety lock	49	Audi drive select	117
Power windows	49	Suspension	118
		Steering	120

All wheel drive (quattro)	121	Using the Audi phone box	192
Electronic Stabilization Control	122	Using the Rear Seat Remote	194
Trailer towing	124	Using the telephone	195
Driving with a trailer	124	Settings	199
Trailer hitch	126	Messages	200
Assist systems	127	Troubleshooting	201
Assist systems	127	Audi connect	203
General information	127	General information	203
Surrounding area detection	128	Audi connect Infotainment	204
Driver assistance menu	131	Connecting to Wi-Fi	204
Parking aid menu	131	Using a Wi-Fi hotspot	205
Driving information	133	Audi connect Infotainment services	205
Speed warning system	133	Audi connect apps	206
Camera-based traffic sign recognition	133	Audi connect vehicle control services	206
Traffic light information	135	Settings	207
Lap timer	136	Troubleshooting	208
Night vision assist	137	Emergency call	209
Integrated Toll Module	139	Overview	209
Driver assistance	141	Emergency call	209
Cruise control system	141	Online roadside assistance	210
Efficiency assist	142	Navigation	212
Adaptive cruise assist	144	Opening navigation	212
Distance warning	156	myAudi navigation	212
Lane departure warning	157	Entering a destination	213
Audi pre sense	159	Stopping route guidance	216
Side assist	163	Map	216
Exit warning	165	Predictive route guidance	218
Intersection assistant	166	Alternative routes	219
Emergency assist	167	Additional functions	219
Parking and maneuvering	169	Satellite map	220
Introduction	169	Map update	220
Parking aid plus	169	Traffic incidents	221
Rearview camera and peripheral cameras	172	Settings	222
Rear cross-traffic assist	176	Radio	224
Assisted parking	177	General information	224
Park assist plus	179	Radio functions	225
Remote controlled parking	183	Online radio	228
Maneuver assist	188	Options and settings	229
Infotainment system	190	Troubleshooting	230
Telephone	190	Media	232
Introduction	190	General information	232
Setup	190	Bluetooth audio player	232
		Online media	233

Table of contents

Multimedia connections	233	Do it yourself	300
Media playback	235	Emergency assistance	300
Options and settings	238	General information	300
Supported media and file formats	238	Equipment	300
Troubleshooting	240	Replacing wheels	300
Interactive experience	241	Space-saving spare tire	304
Themes	241	Jump starting	304
holoride interface	241	Towing	306
Smartphone interface	243	Fuses and bulbs	309
Setup	243	Fuses	309
Troubleshooting	244	Bulbs	313
Additional settings	246	Customer information	314
System settings	246	Data privacy	314
Software update	247	Privacy notice	314
Connected devices	247	Image recording	314
Legal information	248	Data memories	314
Maintenance and Care	250	Transmitted information	316
Checking and Filling	250	Accessories and technical	
Fuel	250	changes	319
Refueling	251	Warranty	319
Emissions control system	253	Audi Literature Shop	319
Engine compartment	253	Driving in other countries	319
Engine oil	256	Maintenance, repairs, and technical	
Cooling system	260	modifications	319
Brake fluid	262	Accessories and parts	321
Electrical system	263	Reporting Safety Defects	321
Battery	264	Technical data	323
Windshield washer system	267	Identification data	323
Service interval display	267	Vehicle data	323
Wheels	269	Other information	325
Tires and rims	269	Online Car Care	325
Tire pressure monitoring system	287	Brands and licenses	325
Tire pressure monitoring system	289	Disposal instructions	325
Care and cleaning	293	Declaration of compliance for	
General information	293	telecommunications equipment and	
Car washes	293	electronic systems	325
Cleaning and care information	294	Index	327
Taking your vehicle out of service	299		

This manual contains important information, safety precautions, and tips for using your vehicle.

READ THIS OWNER'S MANUAL AND KEEP IT!

Read this Owner's Manual carefully before using your vehicle. Keep this manual and any other applicable documents in your vehicle at all times. This is especially important if you loan your vehicle to others or sell it.

Updates to the Owner's Manual: Please note that it has always been Audi's¹⁾ policy to continuously improve its products. Audi reserves the right to make changes in design and specifications, and to make additions or improvements in its products without incurring any obligation to install them on products previously manufactured. Changes by means of software updates may be possible, depending on the vehicle and market. Therefore, it is also possible that the Owner's Manual may be updated. This will be done in the form of supplements. Supplements may be provided to you in both printed and digital form. Notes in the supplement will indicate if a digital or printed supplement applies to you.

Vehicle-specific features: Standard equipment, equipment for specific markets, and special equipment that is available for the entire model line is described. In addition, it is possible that some of the equipment and functions will only be available at a later time or they may only be available in certain markets. Therefore, the descriptions also include items that are not available in your specific vehicle. The illustrations in this manual are a guide. Some of the details in your vehicle may differ from the illustrations. Text, illustrations, and specifications are based on the most current information available at the time of printing, and shall not constitute a basis for liability claims.

Identifying if information is applicable: Some sections do not apply to all vehicles. When this is the case, the beginning of the section indicates the applicability, for example "Applies to:

vehicles with speed warning system". In addition, optional or vehicle-specific equipment and functions may be indicated with an asterisk "*" or a corresponding comment (such as "depending on vehicle equipment").

Symbols and standards for descriptions in the Owner's Manual:

- * Optional or vehicle-specific equipment
- ▶ The section continues on the next page.
- ⇒ *page 81* Cross reference to other descriptions or topics.
- ⇒ ⚠ Cross reference to a "WARNING".

Directions, such as "left", "right", "front" and "rear", are based on the vehicle's direction of travel.



WARNING

Text with this symbol contains information about safety and how to reduce the risk of serious personal injury or death.



Note

Text with this symbol contains information about reducing the risk of damage to your vehicle.



For the sake of the environment

Text with this symbol contains information on protecting the environment.



Tips

Text with this symbol contains additional useful information.

¹⁾ "Audi" refers to AUDI AG, the respective importer in a country, as well as joint ventures.

Quick access

Online information

myAudi

You can access the digital form of your Owner's Manual on your mobile device using myAudi.

Requirement: you must have a registered myAudi account. Your vehicle must be registered in your myAudi account.

- ▶ Visit my.audi.com, or
- ▶ Start the myAudi app on your mobile device.

Online Owner's Manual

Applies to: vehicles with Online Owner's Manual

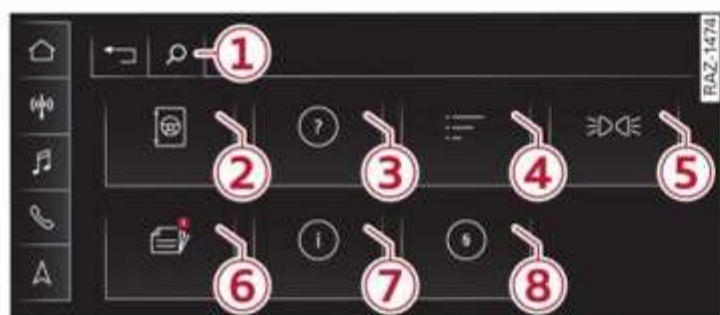

Fig. 1 Upper display: Online Owner's Manual

The Online Owner's Manual can be accessed directly from the Owner's Manual in the Infotainment system. Each time you access the Owner's Manual, it will automatically display in the language that is set for your MMI.

Accessing the Online Owner's Manual

Requirement: the vehicle must be stationary.

- ▶ Applies to: MMI: Select on the home screen: **HELP > Owner's manual**.

Functions and operation

① Free text search

Using the free text search, you can search for terms in the entire contents of the Owner's Manual. The search results will be grouped based on their topic.

- Press the button and enter the desired search term.

② Chapter

You can display the contents of the Owner's Manual sorted by topic.

③ FAQ

In order to get to know your vehicle, you can find answers to frequently asked questions in the FAQ section.

④ Index

Using the index, you can search for a specific term and quickly access relevant information.

⑤ Indicator lights

An overview of all available indicator lights and their meanings will be displayed.

- Press on any indicator light to display its meaning.

⑥ Supplements

Supplements will be created if changes to the Owner's Manual are necessary. The **Supplements** menu will only appear if supplements are available. A notification icon displays the number of supplements that are available. This icon will disappear once the **Supplements** menu has been opened.

⑦ Info

An overview of general information about the Owner's Manual will be displayed. You can also change the language in which the Online Owner's Manual content is displayed. The language will be reset when you exit the Online Owner's Manual.

Change language

- Applies to: MMI: Select on the home screen: **HELP > Owner's manual > Info > Change language**.

⑧ Legal notes

An overview of all legal notes pertaining to the Online Owner's Manual will be displayed.

WARNING

To reduce the risk of an accident, only use the Online Owner's Manual when the vehicle is parked safely.

Tips

The content is the information that was available at the time of the editorial deadline for this manual. There may be changes over the service life of the vehicle.

FAQ

Before driving

- How do I adjust the seat? ⇒ *page 67.*
- How do I adjust the steering wheel? ⇒ *page 74.*
- How does the selector lever work? ⇒ *page 105.*
- What are the selector lever positions and driving programs? ⇒ *page 105.*
- How does the electromechanical parking brake work? ⇒ *page 114.*
- How do I adjust the exterior mirrors? ⇒ *page 61.*
- How do I refuel my vehicle? ⇒ *page 251.*
- How do I operate windshield wipers with the rain sensor? ⇒ *page 63.*
- Where is the washer fluid reservoir located? ⇒ *page 256.*
- How do I store the tire pressures? ⇒ *page 289* or ⇒ *page 291.*
- How do I drive with a trailer? ⇒ *page 124.*

Vehicle breakdowns and emergencies

- How do I jump start my vehicle? ⇒ *page 304.*
- Where can I find the correct tire pressure? ⇒ *page 280.*
- What type of airbags are equipped in my vehicle? ⇒ *page 81.*
- Where are the towing loops located on the vehicle? ⇒ *page 306.*

Advanced functions

- How is the distance to the vehicle driving ahead of me automatically maintained? ⇒ *page 144.*
- How does the adaptive cruise assist respond automatically to speed limits and road conditions? ⇒ *page 150.*
- How can I stay in the lane more easily? ⇒ *page 148.*
- How can I be warned when leaving a lane? ⇒ *page 157.*
- How do I use the parking aid? ⇒ *page 169.*
- How can I more safely drive through intersections and exits with poor visibility? ⇒ *page 166* or ⇒ *page 174.*

- How can the high beam headlights be controlled automatically? ⇒ *page 57.*
- How can I monitor the blind spot more easily when changing lanes? ⇒ *page 163, Side assist.*
- How can I adjust the vehicle handling based on the driving situation and my preferences? ⇒ *page 117, Audi drive select.*
- How do the swerve assist and turn assist help me? ⇒ *page 161* or ⇒ *page 162.*

Display and operation

- How do I turn on the touch displays? ⇒ *page 22.*
- How do I operate the touch displays? ⇒ *page 20.*
- How do I control the volume? ⇒ *page 33.*
- How do I navigate through the menus? ⇒ *page 23.*
- How do I write letters and numbers by hand? ⇒ *page 27.*
- How do I operate functions such as the navigation by voice? ⇒ *page 31.*
- Which functions can I operate with the buttons on the steering wheel? ⇒ *page 16* or ⇒ *page 33.*
- How do I display information on the windshield? ⇒ *page 30, Head-up display.*
- How can I adjust the brightness of the instrument and display lighting? ⇒ *page 61.*

Infotainment system

- How can I connect my mobile device to use the hands-free system? ⇒ *page 190.*
- How can I switch between connected devices? ⇒ *page 247.*
- How can I access information online? ⇒ *page 203, Audi connect.*
- How can I use the Wi-Fi hotspot? ⇒ *page 205.*
- What are the different ways I can enter a navigation destination? ⇒ *page 213.*
- How can I operate the map functions? ⇒ *page 216.*
- How can I display traffic information? ⇒ *page 221.*
- How can I listen to the radio? ⇒ *page 224.*
- How can I play media? ⇒ *page 235.*

- How can I play music from my mobile device on the Infotainment system? ⇒ *page 232, Bluetooth audio player.*

Tips and tricks

- How can I unlock my vehicle from the inside for other persons to enter? ⇒ *page 39.*
- How can I open all the windows from the outside using the remote control key? ⇒ *page 50, Convenience opening and closing.*
- How can I synchronize both sides of the climate control system? ⇒ *page 98.*
- How can I deactivate the front passenger's airbag? ⇒ *page 83.*
- How do I secure a child safety seat? ⇒ *page 85.*
- What should I consider when driving through a car wash? ⇒ *page 293.*
- How can I drive in a way that is efficient and environmentally-friendly? ⇒ *page 109.*
- How can I request the next service appointment? ⇒ *page 267.*

Cockpit

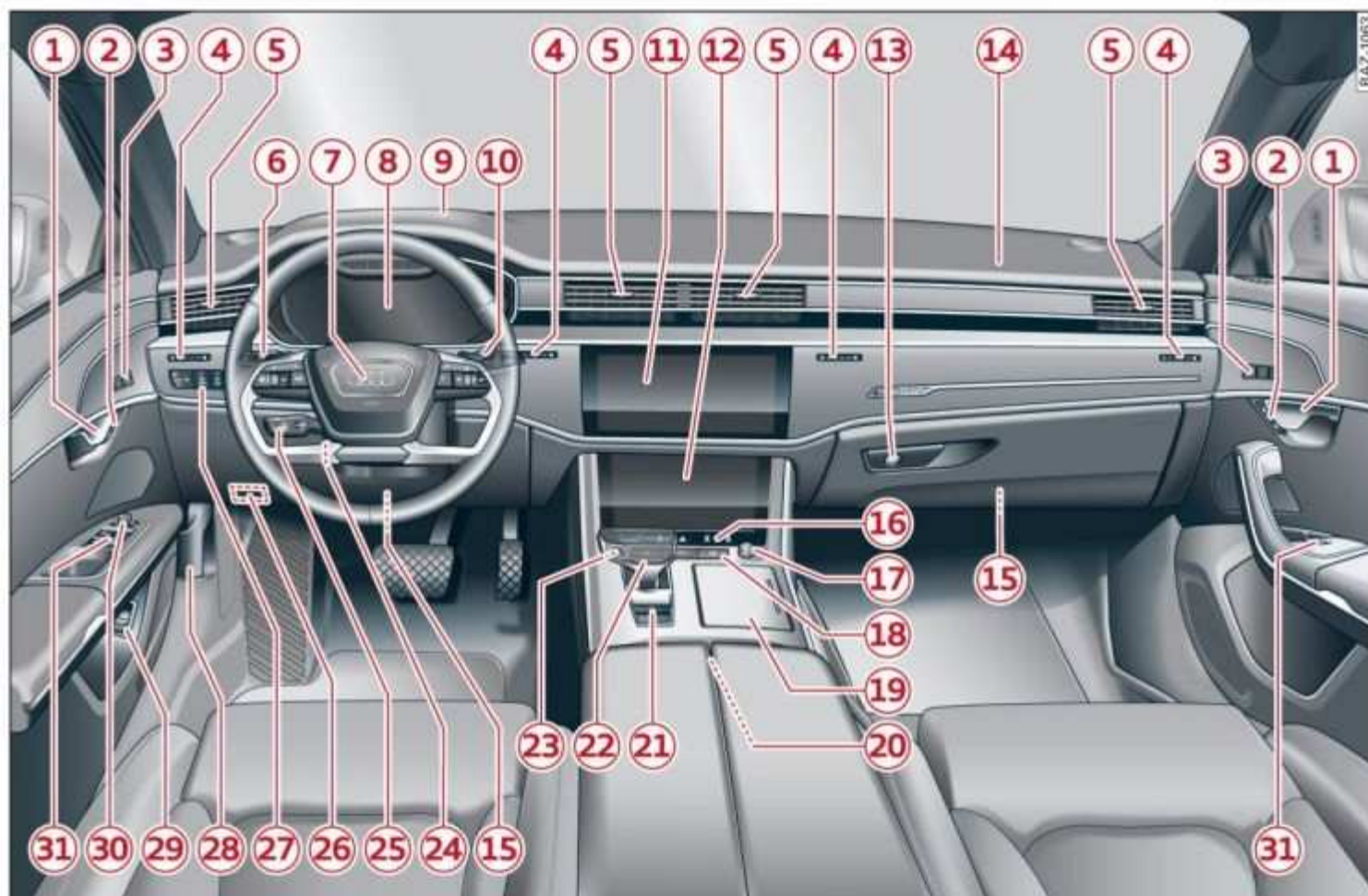

Fig. 2 Cockpit

① Door handle			
② Central locking switch	39		
③ Memory function buttons	80		
④ Adjusting the air vents	100		
⑤ Vent			
⑥ Lever for:			
– Turn signals and high beams	57		
– High beam assistant	57		
– Lane departure warning	157		
– Lane guidance	148		
⑦ Multifunction steering wheel with:			
– Horn			
– Driver's airbag	81		
– Operating buttons	16, 33		
– Shift paddles	107		
⑧ Instrument cluster	15		
⑨ Head-up display	30		
⑩ Windshield washer system lever	63		
⑪ Upper display	22		
⑫ Lower display	22		
⑬ Lockable glove compartment with:			
– Switch for cooled glove compartment		92	
– Valet Parking function		52	
⑭ Front passenger's airbag		81	
⑮ Knee airbag		81	
⑯ Depending on equipment, buttons for:			
– drive select		117	
– Electronic Stabilization Control (ESC)		123	
– Emergency flashers		59	
– Defrosting		97	
– Rear window defogger		97	
⑰ MMI On/Off button		22, 33	
⑱ Depending on equipment, buttons for:			
– Parking aids		169	
– Park assist plus		179	
– Driver assistance systems		131	
⑲ Depending on equipment:			
– Cup holder		92	▶

- Socket 91
- 20 Depending on equipment:
 - Starting the engine when there is a malfunction 104
 - USB ports with charging function 234
 - Audi phone box 192
- 21 Electromechanical parking brake button 114
- 22 Automatic transmission selector lever 105
- 23 **START ENGINE STOP** button 103
- 24 Steering wheel adjustment 74
- 25 Lever for:
 - Cruise control system 141
 - Adaptive cruise assist 144
- 26 Connection port for the On Board Diagnostic System (OBD) 314
- 27 Buttons for:
 - Lights 56
 - All-weather lights 56
 - Rear fog lights 56
- 28 Hood release 255
- 29 Button for:
 - Luggage compartment lid 45
- 30 Exterior mirror adjustment 61
- 31 Buttons for:
 - Power windows 49
 - Child safety lock 49

i Tips
Some of the equipment listed here is only installed in certain models or is available as an option.

Indicator lights overview

Description



The indicator lights in the instrument cluster blink or turn on. They indicate functions or malfunctions. Some warning and indicator lights turn on when you switch the ignition on and must turn off when the drive system is switched on or while driving.

With some indicator lights, messages may appear and warning signals may sound. The indica-

tor lights and messages may be covered by other displays. To show them again, select the second tab for messages with the multifunction steering wheel ⇒ *page 16*.







Some indicator lights in the display can display in several colors.















⚠ Central indicator light





If the  or  indicator light turns on, check the message in the instrument cluster.

Overview















The following indicator lights may be available, depending on the vehicle equipment:

































Red indicator lights	
	Central indicator light ⇒ <i>page 10</i> , Instrument cluster ⇒ <i>page 15</i>
	Cooling system ⇒ <i>page 17</i> , ⇒ <i>page 260</i> , ⇒ <i>page 260</i> , ⇒ <i>page 261</i>
	Safety belt ⇒ <i>page 79</i>
	Engine start system ⇒ <i>page 104</i>
	Transmission ⇒ <i>page 108</i>
	Drive system ⇒ <i>page 110</i> , Electrical system ⇒ <i>page 263</i>
BRAKE	Brake system ⇒ <i>page 113</i> , ⇒ <i>page 262</i> , Electromechanical parking brake ⇒ <i>page 115</i>

	Brake system ⇒ page 113, ⇒ page 262, Electromechanical parking brake ⇒ page 115
PARK	Electromechanical parking brake ⇒ page 114
	Electromechanical parking brake ⇒ page 114
	Air suspension ⇒ page 119
	Steering ⇒ page 120
	Steering ⇒ page 120
	Night vision assist ⇒ page 138
	Night vision assist ⇒ page 138
	Adaptive cruise assist ⇒ page 146, Brake intervention request ⇒ page 149, Safe start monitor ⇒ page 154
	Adaptive cruise assist ⇒ page 146, ⇒ page 150
	Steering intervention request (Adaptive cruise assist) ⇒ page 150
	Distance warning ⇒ page 156
	Lane departure warning ⇒ page 157
	Lane departure warning ⇒ page 157
	Pre sense ⇒ page 160, ⇒ page 160, Intersection assist ⇒ page 166
	Hood ⇒ page 255

	Engine oil pressure ⇒ page 257
	Engine oil level (MIN) ⇒ page 257
	Electrical system ⇒ page 263
	Loose wheel warning ⇒ page 285, ⇒ page 285

Yellow indicator lights

























	Central indicator light ⇒ page 10
	Engine speed limitation ⇒ page 17
	Engine speed limitation ⇒ page 17, Drive system ⇒ page 110
	Central locking ⇒ page 39
	Battery in remote control key ⇒ page 44
	Bulb failure indicator ⇒ page 59
	Adaptive light ⇒ page 59
	Headlight range control system ⇒ page 59
	Light/rain sensor ⇒ page 59, ⇒ page 65
	Windshield wipers ⇒ page 65
	Safety systems ⇒ page 82
	Engine start system ⇒ page 104
	Convenience key ⇒ page 104
	Transmission ⇒ page 108

	Brake system ⇒ page 113		Side assist, exit warning ⇒ page 164
	Electromechanical parking brake ⇒ page 115		Intersection assist ⇒ page 166
	Active suspension ⇒ page 119, Air suspension ⇒ page 119		Emergency assist ⇒ page 168
	Steering ⇒ page 120		Parking aids ⇒ page 171
	Steering ⇒ page 120		Rear cross-traffic assist ⇒ page 176
	Sport differential ⇒ page 122		Park assist plus ⇒ page 182
	Electronic Stabilization Control (ESC) ⇒ page 123, ⇒ page 123		Maneuver assist ⇒ page 189
ESC OFF	Electronic Stabilization Control (ESC) ⇒ page 123		Emergency call function ⇒ page 210
	Electronic Stabilization Control (ESC) ⇒ page 123		Tank system ⇒ page 251
ABS	Anti-lock Braking System (ABS) ⇒ page 123		Malfunction Indicator Lamp (MIL) ⇒ page 251, ⇒ page 253
	Anti-lock Braking System (ABS) ⇒ page 123		Engine oil level (MIN) ⇒ page 257
	Steering intervention request (Adaptive cruise assist) ⇒ page 150, Steering intervention request (Lane departure warning) ⇒ page 158		Engine oil level (MAX) ⇒ page 257
	Adaptive cruise assist ⇒ page 155		Engine oil sensor ⇒ page 257
	Distance warning ⇒ page 156		Engine warm-up request ⇒ page 257
	Lane departure warning ⇒ page 159		Electrical system ⇒ page 263
	Pre sense ⇒ page 159, ⇒ page 162		Washer fluid level ⇒ page 267
			Loose wheel warning ⇒ page 285
			Tire pressure ⇒ page 288, ⇒ page 291
		TPMS	Tire pressure ⇒ page 288, ⇒ page 291

Other indicator lights

	Low beam headlights ⇒ page 56		Adaptive cruise assist ⇒ page 146
	Parking lights ⇒ page 56, low beam headlights ⇒ page 56		Driving starts automatically (adaptive cruise assist) ⇒ page 146
	Turn signals ⇒ page 57, ⇒ page 59		Adaptive cruise assist ⇒ page 146
	Turn signals ⇒ page 57, ⇒ page 59		Lane departure warning ⇒ page 157
	Rear safety belt ⇒ page 79		Park assist plus ⇒ page 180
	Start/Stop system ⇒ page 111		High beam headlights ⇒ page 57, ⇒ page 58
	Cruise control system ⇒ page 141		High beam assistant ⇒ page 57
	Cruise control system ⇒ page 141		Rear seat reminder ⇒ page 39
	Efficiency assist ⇒ page 143		Door lock ⇒ page 39
	Efficiency assist ⇒ page 143		Child safety lock ⇒ page 49
	Efficiency assist ⇒ page 143		Child safety lock ⇒ page 49
	Efficiency assist ⇒ page 143		Valet Parking activated ⇒ page 52
	Efficiency assist ⇒ page 143		High beam assistant ⇒ page 57, ⇒ page 59
	Efficiency assist ⇒ page 143	OLED	OLED tail lights ⇒ page 59
	Adaptive cruise assist ⇒ page 146		Rear safety belt ⇒ page 79
	Adaptive cruise assist ⇒ page 146		Convenience key ⇒ page 104
	Traffic jam assist ⇒ page 146, ⇒ page 149		Transmission ⇒ page 108
	Adaptive cruise assist ⇒ page 146		Start/Stop system ⇒ page 111
	Adaptive cruise assist ⇒ page 146		Electromechanical parking brake ⇒ page 115
			Electromechanical parking brake ⇒ page 115

Quick access

	Active suspension ⇒ page 119		Emergency assist ⇒ page 168
	Steering ⇒ page 120		Emergency assist ⇒ page 168
	Speed warning system ⇒ page 133		Parking aids ⇒ page 171
	Speed warning system ⇒ page 133		Rear cross-traffic assist ⇒ page 176
	Camera-based traffic sign recognition ⇒ page 134		Park assist plus ⇒ page 182
	Night vision assist ⇒ page 139		Park assist plus ⇒ page 182
CRUISE	Cruise control system ⇒ page 142		Maneuver assist ⇒ page 188, ⇒ page 189
	Cruise control system ⇒ page 142		
	Efficiency assist ⇒ page 143, ⇒ page 151, Adaptive cruise assist ⇒ page 155		
	Adaptive cruise assist ⇒ page 146, ⇒ page 149		
	Lane guidance (adaptive cruise assist) ⇒ page 149		
	Adaptive cruise assist ⇒ page 152		
	Distance warning ⇒ page 156		
	Lane departure warning ⇒ page 157		
	Lane departure warning ⇒ page 157		
	Lane departure warning ⇒ page 159		
	Side assist, exit warning ⇒ page 164		
	Intersection assist ⇒ page 166		

Instrument cluster

Instrument cluster overview



Fig. 3 Instrument cluster overview (Audi virtual cockpit)

Depending on the vehicle equipment, the following items may appear in the instrument cluster:

- | | | |
|---|---|-----|
| ① | Display | |
| | – Engine coolant temperature . . . | 17 |
| ② | Left dial | |
| | – Tachometer | 17 |
| ③ | Tab area | 16 |
| ④ | Central area | 16 |
| ⑤ | Status bar (one or two lines) | |
| ⑥ | Right dial | |
| | – Convenience display | |
| ⑦ | Fuel level | 251 |
| ⑧ | Right additional display with speedometer | |
| ⑨ | Left additional display with: | |
| | – Selector lever position | 105 |
| | – Audi drive select mode | 117 |

Tips

- You can select the units used for temperature, speed, and other measurements in the Infotainment system ⇨ *page 246*.
- Speeds are displayed in mph (miles per hour) or km/h (kilometers per hour).
- Certain instrument cluster content can also be displayed in the head-up display* ⇨ *page 30*.

WARNING

If there is a serious system malfunction, the display may turn off. The indicator light may also turn on. Stop the vehicle safely. See an authorized Audi dealer or authorized Audi Service Facility for assistance.

Operating

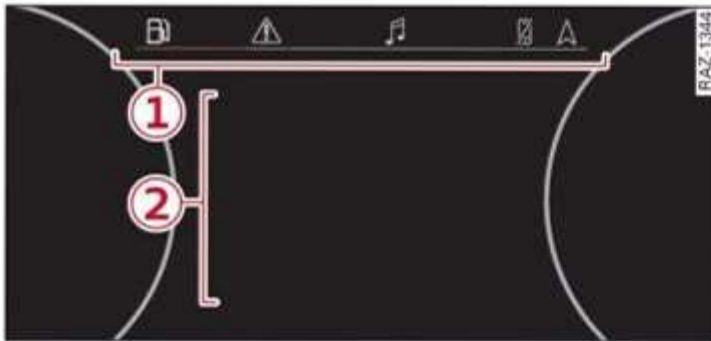

Fig. 4 Instrument cluster: driver information system

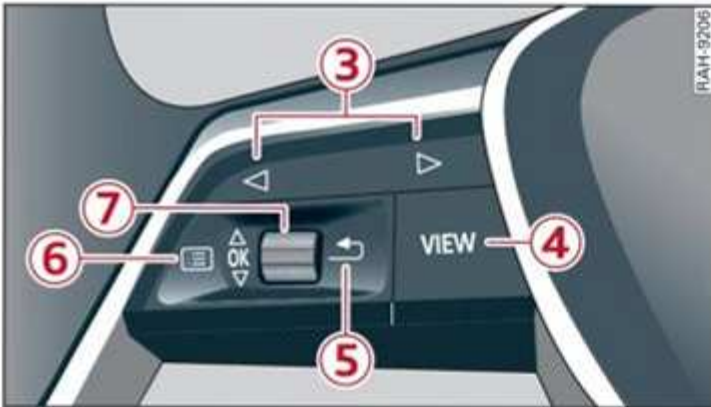

Fig. 5 Left side of multifunction steering wheel

Information is organized within various tabs ① in the instrument cluster. The tab contents are displayed in the central area ②.

Requirement: the ignition must be switched on.

Selecting a tab

- ▶ Press the </> button ③ repeatedly until the desired tab is selected.

Returning to functions at higher levels

- ▶ Press the ↶ button ⑤.

Opening and closing the menu

- ▶ Press the ☰ button ⑥.

Selecting and confirming a function

Requirement: a menu or list must be displayed.

- ▶ To select a function, turn the left thumbwheel ⑦ to the desired function.
- ▶ To confirm a selection, press the left thumbwheel ⑦.

Switching the view

- ▶ Press the VIEW button ④.

Overview of the tabs

Depending on vehicle equipment, the following tabs may be available:

Symbol	Description
	Vehicle functions
	Driver messages (this is only displayed if at least one indicator light/message is being displayed)
	Driver assistance display with area view
	Night vision assist (this is only displayed if the night vision assist has been activated)
	Multimedia
	Telephone
	Navigation

Adjusting the display

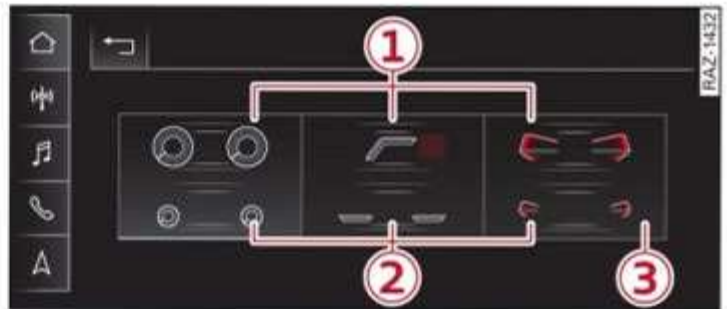

Fig. 6 Upper display: adjusting the display

Switching the view

- ▶ Press the VIEW button to switch between the default view ① and the enhanced view ②.

Adjusting the layout

Depending on the vehicle equipment, various layouts may be available.

- ▶ Applies to: MMI: Select on the home screen: **SETTINGS > Display & Brightness > Audi virtual cockpit**.
- ▶ To adjust the desired layout, press ③.

Adjusting the additional display

Depending on the vehicle equipment, the additional displays that can be selected may vary.

- ▶ Applies to: MMI: Select on the home screen: **SETTINGS > Display & Brightness > Audi virtual cockpit > Configure**.

- ▶ Select the desired additional display.

Reducing the display

Depending on the vehicle equipment, you can hide the central area in the instrument cluster.

- ▶ Select on the instrument cluster: vehicle functions tab >  button > **Reduced display**.

Coolant temperature display

The coolant temperature display  ⇒ *page 15* only functions when the ignition is switched on. To reduce the risk of engine damage, please observe the following notes about the temperature ranges.

Cold range

If only the LEDs at the bottom of the gauge turn on, the engine has not reached operating temperature yet. Avoid high engine speeds, full acceleration, and heavy engine loads.

Normal range

The engine has reached its operating temperature once the LEDs up to the center of the gauge turn on. If the  indicator light in the instrument cluster display turns on, the coolant temperature is too high ⇒ *page 260*.

Note

- Auxiliary headlights and other accessories in front of the air intake impair the cooling effect of the coolant. This increases the risk of the engine overheating during high outside temperatures and heavy engine load.
- The front spoiler also helps to distribute cooling air correctly while driving. If the spoiler is damaged, the cooling effect will be impaired and the risk of the engine overheating will increase. See an authorized Audi dealer or authorized Audi Service Facility for assistance.

Tachometer

The tachometer  ⇒ *page 15* displays the engine speed in revolutions per minute (RPM). The be-

ginning of the red zone in the tachometer indicates the maximum permissible engine speed for all gears once the engine has been broken in. Before reaching the red zone, you should shift into the next higher gear, select the "D" or "S" selector lever position, or remove your foot from the accelerator pedal.

Engine speed limitation

If the  indicator light turns on, the engine will be automatically limited to the RPM displayed in the instrument cluster. This will protect the engine components, for example during a cold start or from overheating.

The engine speed limitation is deactivated if you release the accelerator pedal while the engine is at normal operating temperature.

If the engine speed limitation was activated by an engine control malfunction, the  indicator light also turns on. Make sure the engine speed does not go above the speed displayed, for example when downshifting. Drive to an authorized Audi dealer or authorized Audi Service Facility immediately to have the malfunction corrected.

Note

The needle in the tachometer may only be in the red area of the gauge for a short period of time before there is a risk of damaging the engine. The location where the red zone begins varies depending on the engine.

Odometer

The trip odometer and odometer are displayed in the status bar  ⇒ *page 15*.

The trip odometer shows the distance driven since it was last reset. It can be used to measure short distances. The odometer shows the total distance that the vehicle has been driven.

Resetting the trip odometer

- ▶ Select on the instrument cluster: vehicle functions tab >  button > **Reset mi**.

i Tips

Distances are displayed in mi (miles) or km (kilometers).

Outside temperature display

The outside temperature is displayed in the status bar  ⇒ *page 15*.

If your vehicle is stationary or if you are driving at very low speeds, the temperature displayed in the instrument cluster may be slightly higher than the actual temperature outside due to heat radiating from the motor.

At temperatures below 41 °F (+5 °C), a snowflake symbol appears in front of the temperature display ⇒ .



! WARNING

Do not assume the roads are free of ice based on the outside temperature display. Be aware that there may be ice on roads even when the outside temperature is around 41 °F (+5 °C) and that ice can increase the risk of accidents.

Engine oil temperature indicator

Depending on the vehicle equipment, the engine oil temperature  may be indicated by a bar in the instrument cluster.

► Open the vehicle functions tab and switch to the enhanced view ⇒ *page 16*.

When engine oil temperatures are low, the display --- °F (--- °C) appears in the instrument cluster. The engine has reached its operating temperature when the engine oil temperature is between 176 °F (80 °C) and 248 °F (120 °C) under normal driving conditions. The engine oil temperature may be higher if there is heavy engine load and high temperatures outside. This is not a cause for concern as long as the  or  indicator lights do not turn on.

Boost indicator

Applies to: vehicles with boost indicator

Depending on vehicle equipment, the current engine load (meaning the current boost pressure) may be indicated by a bar in the instrument cluster.

► Open the vehicle functions tab and switch to the enhanced view ⇒ *page 16*.

Vehicle functions

Overview

The trip computer is displayed in the first tab of the driver information system. Additional vehicle functions can be accessed depending on the vehicle equipment.

► Press the  button on the multifunction steering wheel.

- Trip computer ⇒ *page 18*
- Reduced display ⇒ *page 17*
- Reset trip odometer ⇒ *page 17*
- Lap times ⇒ *page 136*
- Lap statistics ⇒ *page 137*

On-board computer

Changing the display

► Turn the left thumbwheel on the multifunction steering wheel  ⇒ *page 16, fig. 5* until the desired display is shown.

Resetting values to zero

Requirement: the **Consumption**, **Short-term memory**, or **Long-term memory** display must be selected.

- To reset the values in one of the memories to zero, press and hold the left thumbwheel on the multifunction steering wheel for one second, or
- Select on the instrument cluster: vehicle functions tab >  button > **Reset mi.**

Displays in the trip computer

The following displays may be shown, depending on the vehicle equipment:

- Time and date ⇨ *page 246*
- Average consumption ⇨ *page 19*
- Short-term memory overview
- Long-term memory overview
- Energy consumers ⇨ *page 19*
- Driver assistance ⇨ *page 145*
- Traffic sign recognition and traffic light information

Short-term memory and long-term memory

The short-term memory collects driving information from the time the ignition is switched on until it is switched off. If you continue driving within two hours after switching the ignition off, the new values will be included when calculating the current trip information.

Unlike the short-term memory, the long-term memory is not erased automatically. You can select the time period for evaluating trip information yourself.

Average consumption

The current consumption can be shown using a bar graph. The average consumption stored in the short-term memory is also displayed. If the bar is green, your vehicle is saving energy (for example, using recuperation).

Energy consumers

The **Energy consumers** view lists other equipment that is currently affecting fuel consumption. The display shows up to three equipment items. The equipment using the most power is listed first. If more than three items using power are switched on, the equipment that is currently using the most power is displayed. A gauge also shows the current total consumption of all other equipment.

Tips

The date, time of day, and time and date format can be set in the Infotainment system
⇨ *page 246*.

Touch displays

General touch display operation

General information

Applies to: touch displays

The touch display is controlled through the touchscreen. Operation is very similar to operating a smartphone.

All touch displays in the vehicle can be operated with the gestures described in the following information.

Tips

Certain gestures may not be available on all touch displays or in every menu.

Pressing

Applies to: touch displays



Fig. 7 Touch display: pressing

Selecting a function or button

- ▶ Press the desired function or button.

Pressing and holding

Applies to: touch displays



Fig. 8 Touch display: pressing and holding

Accessing options

For some items, you can access additional options that are not directly visible.

- ▶ Press and hold an item until the associated options are displayed.

Pressing and pulling

Applies to: touch displays

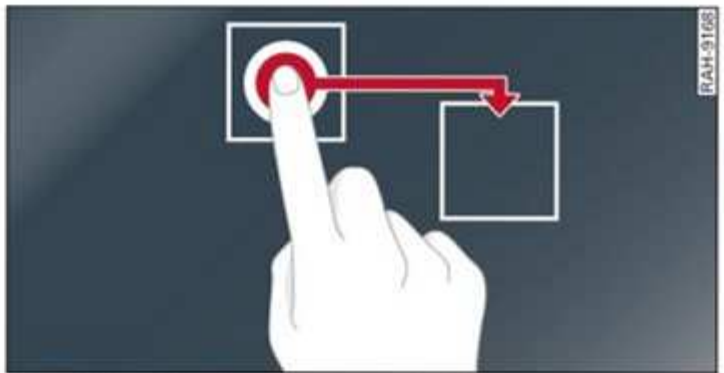

Fig. 9 Touch display: pressing and pulling

Moving an item

You can position some items at any location on the screen.

- ▶ Press and hold an item, and then use your finger to pull it to the desired location.

Creating and deleting folders

- ▶ To create a folder, press and hold an item and drag it onto another one. The folder will be created and a name fitting the category will be assigned ⇨ *page 24*.
- ▶ To delete a folder, move all items out of the folder.

Pinching fingers together and pulling apart

Applies to: touch displays

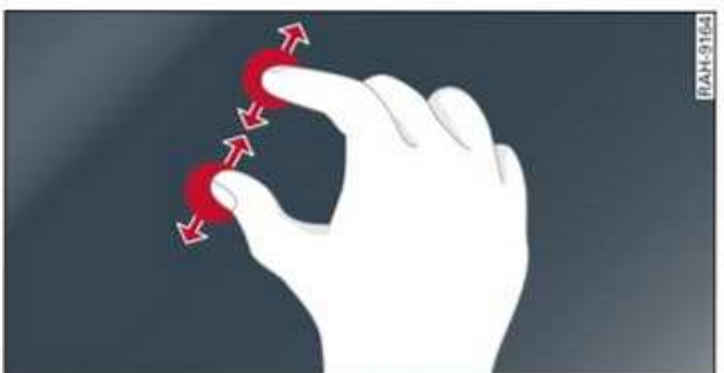

Fig. 10 Touch display: pinching fingers together and pulling them apart

Zooming in and out on an item

- ▶ To increase the size of an item, touch it with two fingers and pull your fingers apart.
- ▶ To decrease the size of an item, touch it with two fingers and pull your fingers together.

Rotating

Applies to: touch displays



Fig. 11 Touch display: rotating

Rotating the view or perspective

- ▶ Rotate the item using two fingers.

Dragging

Applies to: touch displays

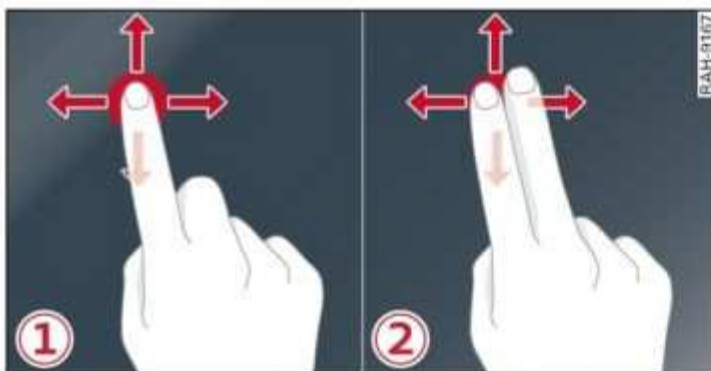

Fig. 12 Touch display: ① dragging with one finger, ② dragging with two fingers

Scrolling or browsing through menus/lists

- ▶ To scroll through menus and lists, swipe upward or downward with one finger.
- ▶ To browse through menus and lists, swipe to the right or left with one finger.

Tilting 3D displays

- ▶ Drag upward or downward with two fingers.

Dragging away from/toward the edge of the screen

Applies to: touch displays

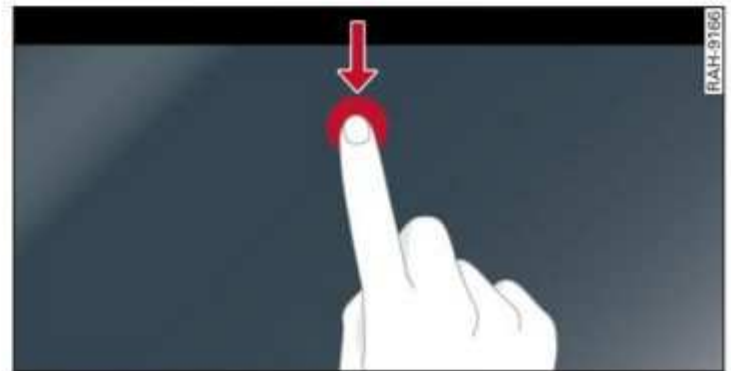



Fig. 13 Touch display: dragging away from the edge of the screen

Opening hidden menus

The  symbol indicates that there is a hidden menu.

- ▶ Use your finger to drag inward from the upper or lower edge of the screen, or
- ▶ Press the  button.

Closing hidden menus

- ▶ Press within the menu and drag it toward the upper or lower edge of the screen.



Information about menu paths

This guide shows you at a glance the paths for opening a desired menu and its settings and functions.

Example of a path

- ▶ Applies to: MMI: Select on the home screen: **SETTINGS** > **General** > **Date & time**.

Following the path

- ▶ First, determine in which display the path should be entered. In this example, it is the MMI display.
- ▶ Applies to MMI: To open the home screen, press .
- ▶ Applies to: Rear Seat Remote: To open the home screen, close any open menus and press  if necessary.
- ▶ If the **SETTINGS** button is not displayed, use your finger to swipe to the left or right until it appears. ▶

- ▶ Press the **SETTINGS** button.
- ▶ If the **General** button is not displayed, swipe toward the left or right with one finger until it appears.
- ▶ Press the **General** button.
- ▶ If the **Date & time** button is not displayed, swipe upward or downward with one finger until it appears.
- ▶ Press the **Date & time** button.

Tips

If a menu or symbol is in parentheses in the path, for example, **(General)** or **()**, then it is an optional menu item that does not need to be used in every system.

Settings

- ▶ Applies to MMI: Select on the home screen: **SETTINGS > Display & Brightness > MMI**.

Possible settings:

- **Brightness**
- **Touchscreen feedback**

Multi Media Interface

Traffic safety information

Audi recommends only using certain Infotainment system functions while the vehicle is stationary, such as entering a destination or pairing a mobile device. Be prepared to stop operating the Infotainment system at any time in the interest of your safety and the safety of other road users.

WARNING

- Only use the Infotainment system when road, traffic, weather, and visibility conditions permit and always in a way that allows you to maintain complete control over your vehicle.
- This also applies to operating your mobile device via the MMI. Do not allow the visual or audio signals from a mobile device to distract you from traffic, because this increases the risk of an accident.

Tips

Certain functions are not available while driving.

Switching on or off



Switching the MMI on or off

- ▶ To switch the MMI off, press and hold the On/Off knob ⇒ *page 33, fig. 21* until the upper display and all Infotainment system functions are switched off.
- ▶ To switch the MMI on, press the On/Off knob.

Restarting the MMI

- ▶ Press and hold the On/Off knob for at least 10 seconds.

Switching displays on or off

- ▶ To switch the upper display off, press  on the lower display.
- ▶ To switch the upper display on, touch the upper display or press  on the lower display.
- ▶ To switch both displays on or off, press and hold  on the lower display.

Introduction

You can display and operate Infotainment system and vehicle functions using both of the Multi Media Interface (MMI) touch displays.

Depending on the vehicle equipment, you may be able to download other apps in addition to the ones that are preinstalled ⇒ *page 206*.

Configuration wizard

After starting for the first time, the configuration wizard helps you to set up the vehicle, for example to set the desired system language and connect a telephone.

- ▶ Follow the instructions in the display.
- ▶ Applies to: MMI: To access the configuration wizard at a later time, select on the home screen: **HELP > Configuration wizard**.

Tool tips

You can have tool tips displayed if necessary. They introduce various MMI functions to you. ▶

- Applies to: MMI: To open the tool tips, select on the home screen: **HELP > Tool tips > Basic information** or **Expert information**.
- Follow the instructions in the display.
- Applies to: MMI: Select on the home screen: **HELP > Owner's manual**.

Online Owner's Manual

Applies to: vehicles with Online Owner's Manual

The Online Owner's Manual can be accessed directly from the Owner's Manual in the Infotainment system ⇒ *page 6*.

Menus and symbols

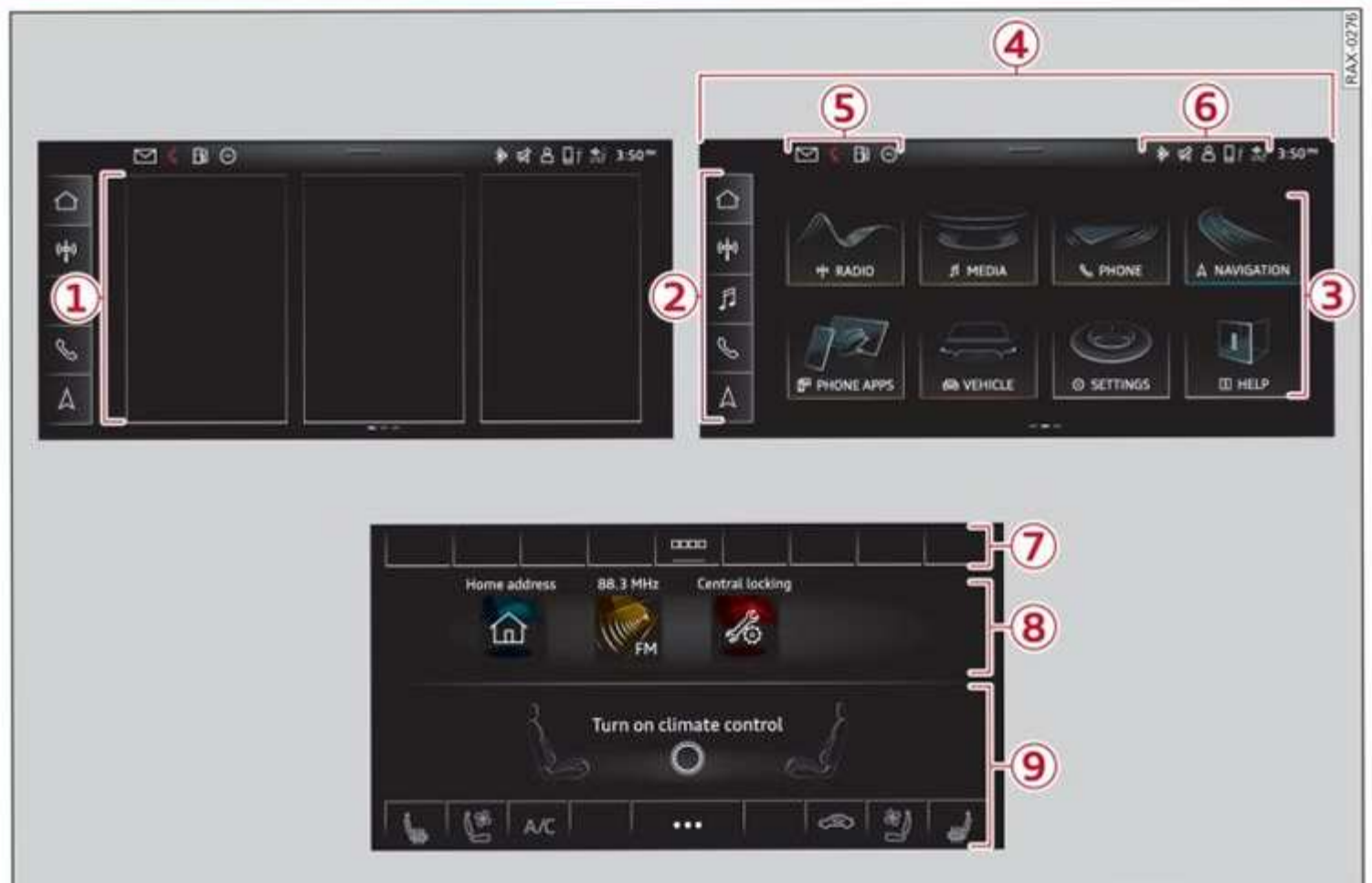















Fig. 14 MMI: upper/lower display

	Label	Description
①	Overview screen	Displays selected information tiles and provides quick access to certain functions ⇒ <i>page 24</i>
②	Quick access bar	Return to the home screen or the overview page, open menus quickly ⇒ <i>page 24</i>
③	Display area	Select a menu, apply settings, display content ⇒ <i>page 24</i>
④ - ⑥	Status bar	Displays existing notifications ⑤ ⇒ <i>page 25</i> , status display ⑥ ⇒ <i>page 25</i> , time
⑦	Function bar	Activate functions or access attached content ⇒ <i>page 26</i>

	Label	Description
8	Shortcuts	Use shortcuts ⇒ <i>page 26</i>
9	Climate control settings	Adjust the climate control system settings ⇒ <i>page 97</i>

Description of common symbols

You can operate the default functions using the symbols that follow. The symbols may be found in any menu, depending on the context.

Symbol	Description
	Go back one level
	Close the menu
	Search for content
	Open explanations for a menu
	Open settings for the selected menu
	Open the submenu
	Adjust the settings
	Set as favorite
	Switch functions on or off
	Switch functions on or off
	Switch functions on or off
	Open additional actions
	Open additional information for the selected menu

Overview screen

The overview screen is the first menu page in the MMI. Information tiles display specific information about certain vehicle functions, such as media. If you are logged in with your myAudi user, the overview screen may contain personalized information depending on vehicle equipment, such as recently used apps. The MMI will display and arrange personalized information automatically.

Switching between the overview screen and the home screen

- ▶ Press  repeatedly until the desired view appears.

Configuring the overview screen

- ▶ Press and hold an information tile on the overview screen.

- ▶ To change the position of an information tile, press and hold it and then slide it to the desired position. Depending on vehicle equipment, the layout of the overview screen can be customized.
- ▶ To replace an information tile, press  and select the desired information tile.
- ▶ Press **Done** to complete the configuration.

Opening the global text search

Depending on vehicle equipment, you can use the global text search to search the MMI for key words.

- ▶ Open the overview screen and swipe your finger to the right.

Quick access

With quick access, you can return to the home screen and quickly switch between four menus that can be configured according to your preferences.

Returning to the home screen or opening a menu quickly

- ▶ Press  or one of the four buttons.

Configuring quick access

- ▶ Press and hold a button on the home screen display area or in the quick access bar.
- ▶ To move a button to the quick access bar, pull it from the display area to the quick access bar.
- ▶ To adjust the placement of the buttons in the quick access bar, pull them to the desired position in the bar.
- ▶ Press **Done** to complete the configuration.

Tips

The position of  cannot be adjusted.

Display area

You can change the location of the buttons and folders on the home screen display area. ▶

Configuring the display area

- ▶ Press and hold a button on the home screen display area.
- ▶ To adjust the placement of the buttons, pull them to the desired locations.
- ▶ To rename a folder, press on the folder name and then enter the desired name.
- ▶ Press **Done** to complete the configuration.

Switching between menu pages

If a menu contains multiple menu pages,  is displayed in the display area. The white bar shows the location of the current menu page.

- ▶ To switch between menu pages, swipe your finger to the right or left.

Status display



Fig. 15 Upper display: common symbols in the status bar

The symbols in the status bar show you information at a glance, such as if a mobile device is connected or if there is a data connection. The most common symbols are listed in the table.

	Description
①	There is a data connection. The bar indicates the signal strength of the data connection. Data is being transmitted now.
②	There is a data connection. The bar indicates the signal strength of the data connection. No data is being transmitted now.
③	A mobile device is connected. The bar indicates the signal strength of the cell phone connection.
④	There is no data connection.
⑤	An error occurred with the mobile device connection to the MMI.

	Description
⑥	A user is selected. If a question mark appears in the symbol  , the guest user is active.
⑦	A Bluetooth device is connected.
⑧	Bluetooth is switched on, but no Bluetooth device is connected.
⑨	Audio playback was interrupted.
⑩	The audio source is muted.
⑪	Privacy settings are enabled. The additional symbol indicates which privacy settings are currently activated ⇒ page 316.
⑫	The Integrated Toll Module is switched on. The numbers 1 - 3+ indicate how many passengers are selected in the MMI.

Notification center



Fig. 16 Upper display: notification center

Notifications from the Audi system and Audi connect apps can be displayed in the upper display. They will be hidden after a certain period of time and a symbol for them will appear in the status bar ⑤ ⇒ page 23, fig. 14. In the notification center, you can view these notifications ② ⇒ fig. 16 and apply quick settings ①.

Depending on the vehicle equipment, system notifications and connect app notifications will be grouped and displayed in separate notification lists ③ / ④.

Using the notification center

- ▶ To open the notification center, pull the status bar downward, or
- ▶ Press the  button on the status bar. ▶

Touch displays

- ▶ To change the notification list, tap on the desired button in the notification center (3) or (4).
- ▶ To apply quick settings, press the respective symbol (1).
- ▶ To obtain additional information about a notification, press it.
- ▶ To delete a notification, pull it toward the right edge of the screen.
- ▶ If there are more than four notifications in the notification center, the older notifications will be hidden. To display the older notifications, drag your finger upward on the screen.





Setting which content is displayed

For some system notifications, you can set if they should be displayed.

- ▶ To set the displayed content, press , or
- ▶ Applies to MMI: Select on the home screen: **SETTINGS > Notifications.**
- ▶ Select and confirm which notifications should be displayed.



Applying quick settings



Depending on vehicle equipment, the following quick settings may be available in area (1):

Symbol	Description
	Apply sound settings
	Open menu settings
	Manage connected devices
	Manage users
3:50 PM 4/9/2017	Set date and time
	Set displayed content in the notification center

Function bar

Depending on the vehicle equipment, you can operate various functions in the function bar.

Symbol	Description
	Switch Start/Stop system on or off
	Opens the parking search
	Opens the garage door opener function

Symbol	Description
	Press: adjust sunshade Press and hold: convenience opening and closing
	Press: shows settings for the head-up display Press and hold: switches the head-up display on or off
	Press: switches the upper display on or off Press and hold: switches both displays on or off

Shortcuts

By creating shortcuts, you have quick access to various items, such as radio stations, frequently used contacts, or vehicle settings.

Adding shortcuts

A **...** button in the upper display indicates, for example, if a selected radio station can be added to the shortcuts. Depending on the context, you may also be able to add items from a list to the shortcuts.

- ▶ Press **...** or press and hold an item in a list.
- ▶ Press **Save as a shortcut**. The selected item will be added to the shortcuts on the lower display and displayed as a tile.

Using shortcuts

- ▶ Press the  (8) ⇨ page 23, fig. 14 button in the function bar on the lower screen. The saved shortcuts will be displayed or hidden.
- ▶ To access the stored function, press the respective tile.

Moving or deleting shortcuts

- ▶ Press and hold a shortcut on the lower display.
- ▶ To adjust the order of the shortcuts, drag a shortcut to the desired location.
- ▶ To delete a shortcut, press . If the shortcut is deleted, the favorite will also be deleted.

Text input

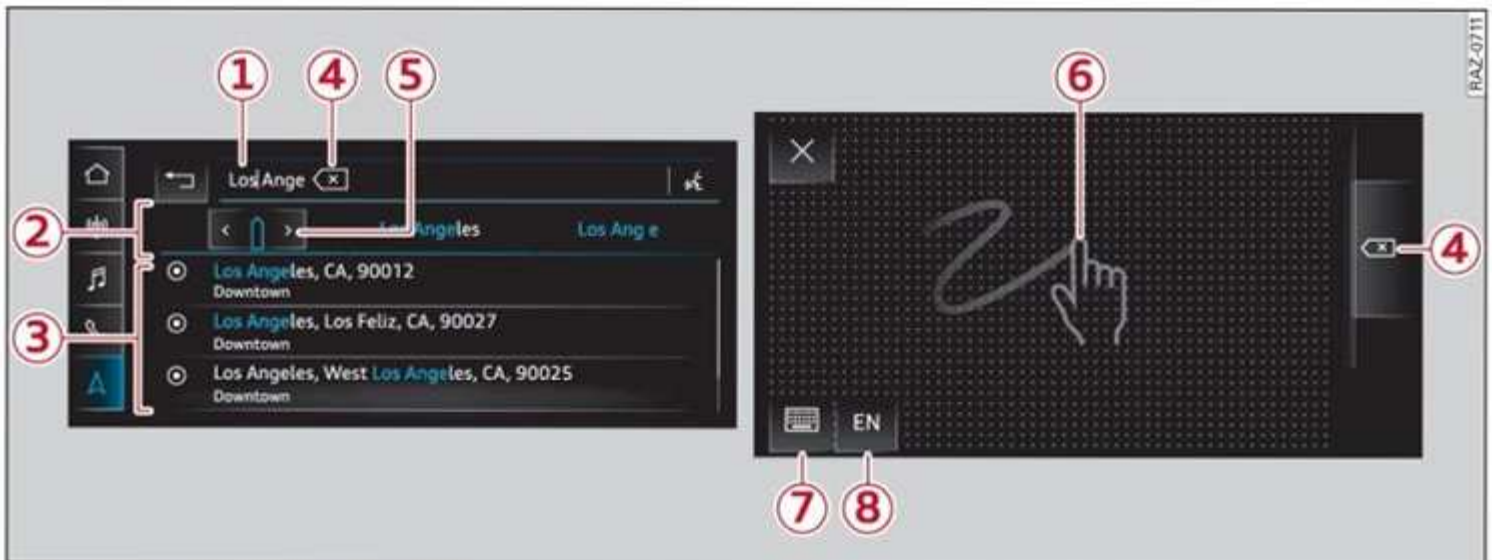

Fig. 17 Upper/lower display: text input

In the input fields of various menus, you can enter letters, numbers and characters, for example to find an address in navigation.

On the lower section of the screen, you can enter the text with handwriting or using the on-screen keyboard. The current text input is displayed on the upper section of the screen ①. Depending on the context, word suggestions may be given based on the characters that have been entered ② and a results list may be shown ③.

Opening text input

- ▶ Tap inside the input field ①.

Switching input languages

Requirement: multiple input languages must be defined in the MMI ⇒ page 28.

- ▶ To switch between the defined input languages, press the button ⑧.

Switching the input methods

- ▶ To switch between handwriting input or the on-screen keyboard, press the button ⑦.

Entering text

- ▶ Applies to: handwriting input: To enter text, simply write in the input area using one finger ⑥. You can write the separate characters next to each other or one on top of the other with-

out having to move your finger over after writing a character. When you end the entry, the writing is interpreted by the system.

- ▶ Applies to: the on-screen keyboard: To enter text, press the buttons on the keyboard. Depending on the usage context, you may also be able to swipe over the letters ¹⁾.
- ▶ Applies to: the on-screen keyboard with an input language that uses accented characters: To enter accented characters (such as â, ç, ñ, ö), press and hold a character that has accented versions available and select the desired accented character.
- ▶ Applies to: handwriting input: To enter a space, drag a line from left to right in the input section ⑥.
- ▶ To select a location in the text input, press on the desired location in the input field. You can control the location more accurately using the slider in the display ⑤.
- ▶ To delete individual characters, press <X> ④, or
- ▶ Applies to: handwriting input: Drag a line from right to left in the input section ⑥.
- ▶ To delete multiple characters, press and hold <X> ④.
- ▶ To delete all characters at a specific location, press and hold <X> ④ and drag up to the desired location ¹⁾. When released, the highlighted characters are deleted.

¹⁾ In certain countries.

Accepting suggested words or selecting entries from the results list

- ▶ To accept a suggested word ② or select an entry from the results list ③, press on it.
- ▶ To display more content in the results list, drag your finger upward or downward on the screen.

Setting the input language or keyboard layout

- ▶ Applies to MMI: Select on the home screen: **SETTINGS > Language & Keyboard > Keyboard**.
- ▶ To define additional input languages, press the  button.
- ▶ To change the keyboard layout for an input language, press >. For example, you can select between QWERTZ and QWERTY.

Rear Seat Remote

Introduction

Applies to: vehicles with Rear Seat Remote

Depending on the equipment, the Rear Seat Remote may be located in the rear center armrest or on the full-length center console. With Rear Seat Remote, you can control convenience and Infotainment system functions in the rear of the vehicle, such as the climate control system or the media playback in the vehicle.

WARNING



As the driver, do not allow usage of the Rear Seat Remote to distract you from driving, as this could increase the risk of an accident.

Note

– Always follow the information found in  in *General information* on page 203.

- Protect the Rear Seat Remote against prolonged exposure to direct sunlight.
- Extremely high or low temperatures that can occur inside vehicles can damage the Rear Seat Remote and/or impair the device performance.
- Avoid applying strong pressure to the display in the Rear Seat Remote, for example by pressing on the display for support.
- Protect the Rear Seat Remote from coming into contact with any fluids.

Tips

- Please note that the Rear Seat Remote can be used only when the ignition is switched on and your vehicle's Wi-Fi hotspot is active.
- Please note that a Wi-Fi connection does not automatically make it possible to use the Internet. For additional information, see the chapter  *page 204*.
- When playing online media sources, there may be longer loading times or restrictions on media playback, depending on the Internet connection or the Wi-Fi usage (for example, if there is intensive usage by multiple devices on the hotspot).
- Signals from Bluetooth devices and Wi-Fi hotspots within range of the vehicle may impair the vehicle Wi-Fi services. If multiple Bluetooth devices and Wi-Fi hotspots are within range of the vehicle, it may cause reduced data transfer rates, connection interruptions, or limitations when streaming media.
- The system complies with United States FCC regulations and ISED regulations  *page 325*.

Menus and symbols

Applies to: vehicles with Rear Seat Remote

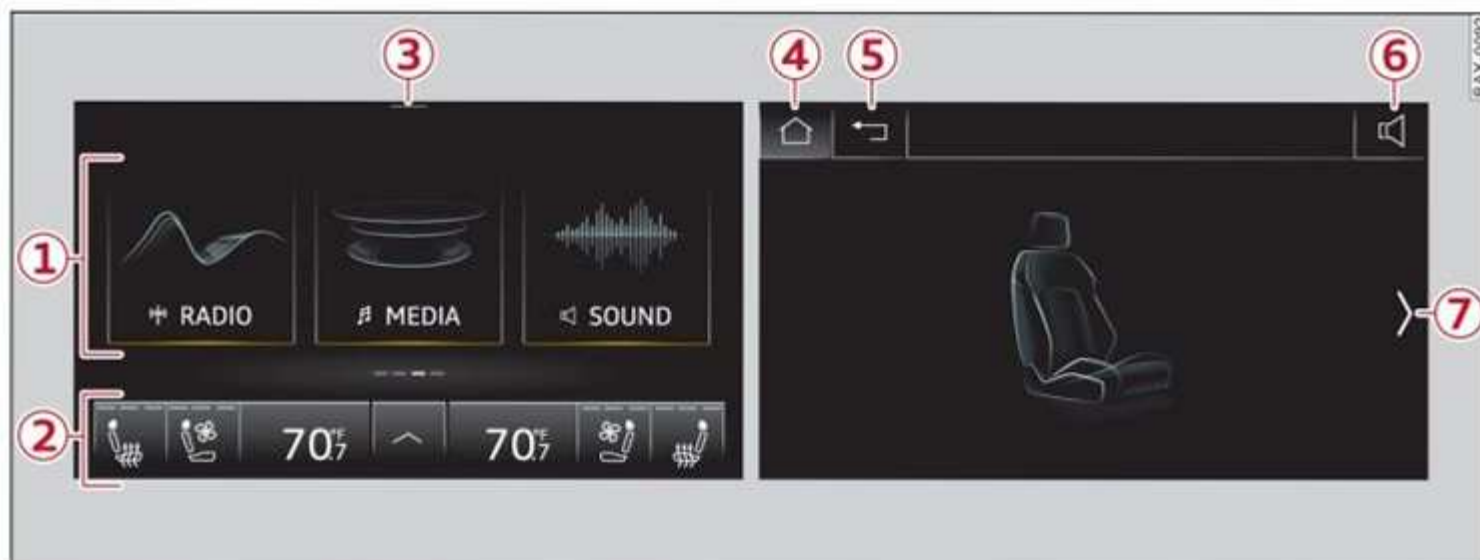

Fig. 18 Display: home screen (left) and submenu (right)

	Symbol/Description	Description
①	Applications	Select and open applications. Depending on the equipment, you may be able to use the following functions: SEATS, LIGHTS, BLINDS, MEDIA, RADIO, PHONE, DEVICES, SOUND, SETTINGS, TIPS, AIR QUAL.
②	Climate control system	Set and operate the climate control system for the rear section ⇒ <i>page 97</i>
③	Quick access	Use your finger to drag downward from the top of the screen to open the quick access area. You can adjust the volume or open telephone functions during a phone call ⇒ <i>page 194.</i>
④	Home screen	Go to the home screen
⑤	Back	Go one step back
⑥	Media playback	Adjusting the volume, opening telephone functions during a phone call ⇒ <i>page 194</i>
⑦	Side selection in vehicle functions	Switching between different seats ⇒ <i>page 72</i>

Settings

Applies to: vehicles with Rear Seat Remote

The Rear Seat Remote settings can be set in the MMI, for example to restrict operation by children.

- Applies to MMI: Select on the home screen: **SETTINGS > Display & Brightness > Operation in rear.**

Possible settings:

Block Rear Seat Remote with parental control button

When the function is switched on and parental control is activated ⇒ *page 49*, the Rear Seat Remote is blocked.

Block rear A/C operation with child safety lock button

When the function is switched on and parental control is activated, climate control operation using the Rear Seat Remote is blocked. You can continue to operate all other content with the Rear Seat Remote.

Head-up display

Description

Applies to: vehicles with head-up display

The head-up display projects certain warnings or selected information from the assist systems on the windshield. The display appears within the driver's field of vision.

Switching on and off

The  button is located in the function bar on the lower display ⇒ *page 23*.

- ▶ To switch the head-up display on or off, press and hold the  button.

Settings in the Infotainment system

- ▶ Applies to: MMI: Select on the home screen: **SETTINGS > Display & Brightness > Head-up display**, or
- ▶ Press the  button.

Possible settings:

- **Display rotation**
- **Brightness**
- **Display height:** you can adjust the height of the display. Sit in the correct seating position ⇒ *page 67* and adjust the head-up display.
- **Display contents:** you can set which information should be displayed. Some information and warnings cannot be hidden.

Note

To reduce the risk of scratches on the glass covering the head-up display, do not place any objects in the projection opening.

Tips

- Sunglasses with polarization filters and unfavorable lighting conditions can impair visibility of the display.
- An optimal display depends on the seat position and the height adjustment of the head-up display.
- A special windshield is needed for the head-up display function.
- For information on cleaning, see ⇒ *table Interior cleaning on page 296*.

Voice recognition system

General information

Applies to: vehicles with voice recognition system

Various functions can be easily operated from the driver's and front passenger's seat using voice commands.

Using the voice recognition system optimally

- ▶ Speak clearly and distinctly at a normal volume. Speak louder when driving faster.
- ▶ Emphasize the words in the commands evenly and do not leave long pauses.
- ▶ To reduce background noise, close all openings, such as doors and windows. Make sure that passengers are not speaking when you are giving a voice command.
- ▶ Do not direct the vents toward the hands-free microphone, which is in the roof headliner near the front interior lights.

WARNING

- Direct your full attention to driving. As the driver, you have complete responsibility for safety in traffic. Only use the functions in such a way that you always maintain complete control over your vehicle in all traffic situations.
- Do not use the voice recognition system in emergencies because your voice may change in stressful situations. The system may take longer to dial the number or may not be able to dial it at all. Dial the emergency number manually.

Tips

There are no voice guidance* prompts when a dialog is active.

Description

Operating the voice recognition system



Applies to: vehicles with voice recognition system



Fig. 19 Upper display: voice recognition system

Requirement: the ignition and the MMI must be switched on. A system language supported by the voice recognition system must be set. There must be no phone calls in progress and the parking aid must not be active.

Operating by button

- ▶ Briefly press the  button on the multifunction steering wheel, or depending on the context, press  in the display.
- ▶ Say the desired command after the signal tone.
- ▶ To switch the voice recognition system off, press and hold the  button on the multifunction steering wheel, or say or press **Cancel** ① ⇒ fig. 19.



Operating with voice commands

- ▶ Applies to: MMI: To operate the voice recognition system using voice commands, select on the home screen: **SETTINGS > General > (Speech dialog system) > Activate the speech dialog system with "Hey Audi"**.
- ▶ Say the activation phrase **Hey Audi** together with the desired command.
- ▶ To switch the voice recognition system off, say **Cancel** or press and hold the  button on the multifunction steering wheel, or press ① ⇒ fig. 19.

Commands and assistance

In the voice recognition system menu, possible commands or help settings are displayed for the current dialog ③.

- ▶ To receive additional help for the current dialog, say or press **Help** ②.

- ▶ To pause voice recognition, say or press **Pause** . To reactivate voice recognition, press  again or briefly press the  button on the multifunction steering wheel.

Additional functions

Applies to: vehicles with voice recognition system

Command during voice output

If the function is switched on, you can simply say a new command during a prompt.

- ▶ Applies to: MMI: Select on the home screen: **SETTINGS > General > Speech dialog system > Allow commands during voice output.**

Online recognizer

Applies to: vehicles with online recognizer

You can activate the online recognizer for additional functions and to improve the results of voice recognition. A supported menu language must be selected. When there is an active Internet connection, the spoken command is evaluated in the vehicle and online.

- ▶ When you switch on the voice recognition system for the first time, a menu for the online recognizer will open, or
- ▶ Applies to MMI: Select on the home screen: **SETTINGS > General > Speech dialog system > Consent to online speech recognizer.**
- ▶ Read the licensing agreements and accept them.

Note

Read the information about Audi connect, and be sure to note the connectivity costs section  in *General information on page 203*.

External voice operation



Applies to: vehicles with external speech dialog system

You can access and control the voice operation on a connected mobile device through your vehicle.

Switching external voice operation on or off

Requirement: the ignition and the MMI must be switched on. A cell phone must be connected to the MMI with the **Handsfree** profile  *page 190*. The mobile device being connected must have

voice control that can be controlled externally. There must be no phone calls in progress and the parking aid must not be active.

- ▶ To switch on the external voice operation, press and hold the  button longer on the multifunction steering wheel.
- ▶ To switch off the external voice operation, press and hold the  button longer on the multifunction steering wheel or press **Cancel**.

Using external voice operation

- ▶ Say the desired command after the signal tone.
- ▶ To reactivate voice recognition when it is paused, press the  button briefly on the multifunction steering wheel or press **Resume**.

Tips

Audi simply provides access to control your cell phone with voice operation and does not take any responsibility for the contents and commands within the external voice control.

Global functions

Additional function buttons

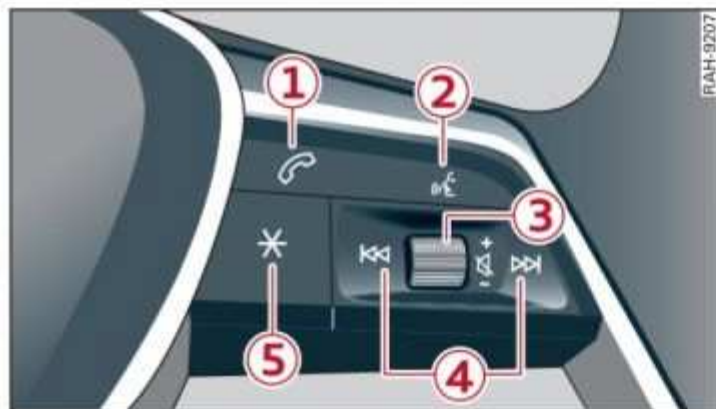

Fig. 20 Right side of the multifunction steering wheel



Fig. 21 MMI On/Off knob with joystick function

Adjusting the volume

You can adjust the volume of an audio source or a system message (for example, from the voice recognition system) when the sound is playing.

- ▶ To increase or decrease the volume, turn the right thumbwheel (3) ⇒ fig. 20 upward or downward, or turn the On/Off knob (3) ⇒ fig. 21 to the right or left.
- ▶ To mute, push the right thumbwheel or the On/Off knob.

Selecting the previous/next track or station

- ▶ Press the |<< / >>| button (4) or briefly press the On/Off knob to the left/right.

Fast forward/rewind

- ▶ Press and hold the |<< / >>| button (4), or press the On/Off knob to the left or right until the desired playback position is reached.

Quick access steering wheel button

Depending on vehicle equipment, the button (5) may provide quick access to various functions.

You can program the * button with various functions.

- ▶ To bring up the function that is currently set, press the * button.
- ▶ To perform the function that is currently set, press and hold the * button, or:
- ▶ Applies to MMI: Select on the home screen: **VEHICLE > Settings & Service > Steering wheel button assignment.**
- ▶ Select and confirm the desired function.

Switching the voice recognition system on or off

☎ button (2), see ⇒ page 31.

Using the telephone functions

☎ button (1), see ⇒ page 195.

! WARNING

Adjust the volume of the audio system so that signals from outside the vehicle, such as police and fire sirens, can be heard easily at all times.

Personalization

Users

General information

Applies to: vehicles with personalized user settings

Depending on vehicle equipment and your country, your vehicle may be able to manage various users in the MMI. Each user will be assigned the settings that they last used.

Before you begin driving, you can select a user in the MMI and load personalized Infotainment and vehicle settings.

Possible users in the MMI:

- **myAudi user:** as a myAudi user, you can use Audi connect services that require a myAudi account. Certain settings are transferred online to your myAudi account. If you log into your myAudi account in another vehicle, you can load your settings in the other vehicle.
- **Local user:** as a local user, you can only store settings in the current vehicle. Your settings cannot be transferred to other vehicles. Audi connect services that can only be used with a myAudi account will not be available.
- **Guest user:** as a guest user, you can store settings in the vehicle without changing the settings for other users. Audi recommends only using the guest user temporarily, because settings can be overwritten by other users.

Depending on vehicle equipment, the following options may be used to detect the active user so that the user settings can be loaded automatically before you start driving.

- Vehicle key

Requirement: the driver's door has been opened.

The detected user must be shown in the MMI. Confirm the user shown, select another user ⇒ *page 34*, or add another user ⇒ *page 34*.

WARNING

It may not be possible to load Infotainment and vehicle settings, or they may only load partially. To reduce the risk of an accident, the driver must be responsible for the Infotain-

ment system settings and vehicle settings at all times.

Tips

- Certain Infotainment and vehicle settings (such as mirrors, last radio stations) may be stored, depending on vehicle equipment. You can find additional information in the MMI. Select on the home screen: **SETTINGS** > **General** > **Legal notes** > **About Audi connect**.
- Applies to: myAudi users: The stored settings can only be transferred to vehicles that are capable of receiving the transmitted information. There may be restrictions that prevent this, particularly in other countries.
- Applies to: myAudi users: The settings can only be transferred and loaded when there is coverage from the applicable mobile phone service provider.
- Applies to: myAudi users with PIN protection switched on: If the MMI displays a detected user but you simply start driving or wait without entering the 4-digit PIN, then the guest user will be selected. Some settings for the detected myAudi user will be transferred to the guest user.

User management

Applies to: vehicles with user management

Opening user management

Applies to: MMI

- ▶ Press **USERS** on the home screen.

Selecting a user

Applies to: MMI

- ▶ Press on the desired user.
- ▶ Enter the 4-digit myAudi PIN, if necessary.

Adding myAudi users

Applies to: MMI and Audi connect

Requirement: you must have successfully registered at my.audi.com and have created a 4-digit myAudi PIN.

- ▶ Press **Add user**.

- ▶ Press **Log in now** to log in with your myAudi credentials.
- ▶ Follow the system instructions.

To transfer existing destinations from the MMI to your myAudi account one time, confirm the system prompts with **Yes**.

You can set a profile pictured for your myAudi user at my.audi.com.

Adding a local user

Applies to: MMI

- ▶ Press **Add user**.
- ▶ Press **Initiate setup**.
- ▶ Press **Local user**.
- ▶ Follow the system instructions.

Edit user

Applies to: MMI

Requirement: the user must be selected and that user's settings must be loaded.

- ▶ Press on the user.

Depending on the user type, available options may include the following.

Changing PIN protection or authentication methods, depending on the vehicle: when this function is switched on, the 4-digit myAudi PIN (short: "SPIN") must be entered before any settings for this user can be loaded.

Remove the user from the vehicle: the user will only be deleted in the vehicle from the list in the MMI.

Change name: you can change the name of the local user.

Removing users

Applies to: MMI

- ▶ Select on the home screen: **Users** >  > *one or more entries* > **Delete**. The user will only be deleted from the list in the MMI. The authorizations for the user in the vehicle (such as key user) will not be removed.

Tips

- The guest user cannot be renamed.

- When changing users, the new user settings are loaded in the vehicle.
- If a user has the  symbol, PIN protection is active. To switch off PIN protection, you can edit the user.
- Depending on the country, you may be able to use an Audi app or my.audi.com.

Key user

Applies to: vehicles with key user management

The vehicle owner must be set as the key user to use some of the specific Audi connect vehicle control services that depend on vehicle equipment.

The key user automatically has remote access authorization. This remote access authorization is necessary to control certain functions that depend on the equipment, such as Audi connect vehicle control services, through the myAudi app.

Setting the key user

Requirement: a key user must not be set yet.

- ▶ To set a key user for the vehicle, you will need a myAudi account. Register in the myAudi app or at my.audi.com.
- ▶ Add your vehicle to the myAudi app.
- ▶ Follow the instructions in the myAudi app.

Managing additional users

Depending on the vehicle equipment, you can grant authorization for additional users to use Audi connect vehicle control services at my.audi.com.

Removing the key user

If you remove the key user, all other users that were stored by the key user at my.audi.com and their authorizations will be deleted. It will no longer be possible to use the Audi connect vehicle control services, depending on the vehicle equipment.

Requirement: a key user must be set. The ignition has been switched on with a vehicle key.

- ▶ Applies to: MMI: Select on the home screen: **USERS** >  > **Remove key user**.

Tips

- Depending on the country and model there may be an app other than the “myAudi app” available for your vehicle. For additional information, see my.audi.com.
- You do not need to log into the vehicle with a myAudi user in order to use Audi connect vehicle control services, which depend on the vehicle equipment.
- If you sell your vehicle, reset all settings to the factory default settings.

Opening and closing

Central locking

General information

WARNING

- If you leave the vehicle, switch the ignition off and take the key with you. This applies particularly when children remain in the vehicle. Otherwise, children could start the vehicle or operate electrical equipment (such as power windows), which increases the risk of an accident.
- No one, especially children, should stay in the vehicle when it is locked from the outside, because the windows can no longer be opened from the inside. Locked doors make it more difficult for emergency workers to enter the vehicle, which puts lives at risk.
- Applies to: child safety lock: No one, especially children, should stay in the vehicle when the child safety lock is activated, because the rear doors and the windows can no longer be opened from the inside. This increases the risk of fatal injury.

Description

All doors and the luggage compartment lid can be centrally unlocked and locked at once. You can select in the MMI if the entire vehicle or only the driver's door should unlock when unlocking the vehicle ⇒ *page 38*. The turn signals flash twice when you unlock the vehicle and flash once when you lock the vehicle. If they do not flash when locking, check if all doors and lids are closed.

Depending on the vehicle equipment, you may have different options for centrally unlocking and locking your vehicle.

- Vehicle key ⇒ *page 43*
- Sensors in the door handles ⇒ *page 43*
- Lock cylinder in the driver's door ⇒ *page 41*
- Interior central locking switch ⇒ *page 39*

Vehicle key

The term "vehicle key" refers to the remote control key or convenience key*. The convenience

key* is a remote control key with special functions ⇒ *page 43* and ⇒ *page 103*.

Power closing*

When closing a door or the luggage compartment lid, you only have to let it fall lightly into the latch. It then closes automatically ⇒ .

Automatic locking

If you unlock the vehicle but then do not open any of the doors, the luggage compartment, or the hood within a short period time, the vehicle locks again automatically. This feature prevents the vehicle from being accidentally left unlocked for a long period of time.

Automatic locking (Auto Lock)

The Auto Lock function locks all doors and the luggage compartment lid once the speed has exceeded approximately 9 mph (15 km/h). The vehicle will unlock again if the unlock function in the central locking switch is pressed, the "P" selector lever position is selected, or the ignition is switched off.



You can open the doors individually from the inside by pulling the door handle one time. To open the rear doors individually, you must pull the door handle twice.

In the event of a crash with airbag deployment, the doors will also automatically unlock to allow access to the vehicle.

Unintentionally locking yourself out

Only lock your vehicle when all of the doors and the luggage compartment lid are closed and there is no key in the vehicle. This reduces the risk of locking yourself out accidentally.

The following features help to reduce the risk of locking your vehicle key in the vehicle:

- If the driver's door is open, the vehicle cannot be locked by pressing the  button on the remote control key or by touching the locking sensor* on a door.
- If the vehicle key that was used most recently is inside the luggage compartment, the luggage compartment lid will automatically open again after it closes ⇒ .

- If the vehicle key that was last used is detected inside the vehicle, then the vehicle cannot be locked from the outside ⇒ .

WARNING

Observe the safety precautions ⇒ [page 37](#).

WARNING

Applies to: vehicles with power closing

- To reduce the risk of injury, make sure that the area where the door is closing is clear during the closing process.
- The closing process can be stopped at any time by pulling on the outer or inner door handle.

Note

The following applies when locking the vehicle:

- If the vehicle key that was last used is detected inside the passenger compartment, then the vehicle cannot be locked from the outside **using the sensor**. Take the vehicle key with you and lock the vehicle again. Otherwise, the vehicle will not be protected against unauthorized access.
- Applies to: vehicles with convenience key: If you try to lock the vehicle **using the button on the vehicle key** while the front passenger's or rear door is open, and you accidentally place the vehicle key inside the passenger compartment and close the door, the vehicle will lock at first. But if the keyless system detects a vehicle key inside the vehicle after it locks, then the vehicle will unlock again. The turn signals will flash several times and a warning tone¹⁾ will sound to indicate this. If you do not open the vehicle to remove the vehicle key within a brief period, then the vehicle will lock automatically. This prevents the vehicle from being left unlocked for long periods of time. The vehicle key will then be locked inside the vehicle.
- Applies to: vehicles with convenience key: If the luggage compartment lid closes and the

system detects that the last vehicle key that was used is inside the luggage compartment, then the luggage compartment lid will open again. The turn signals will flash several times and a warning tone¹⁾ will sound to indicate this. The doors will lock. Always take the vehicle key with you, or unauthorized persons may be able to enter the vehicle.

Tips

- Do not leave valuables unattended in the vehicle. A locked vehicle is not a safe!
- The LED in the driver's door rail blinks when you lock the vehicle. If the LED turns on for approximately 30 seconds after locking, there is a malfunction in the central locking system. Have the problem corrected by an authorized Audi dealer or authorized Audi Service Facility.

Setting the central locking system

You can adjust the central locking system to your preferences. The settings depend on the vehicle equipment.

- ▶ Applies to MMI: Select on the home screen: **VEHICLE > Settings & Service > Central locking**.

Door unlocking

- If you select **All**, all doors and the luggage compartment lid will be unlocked when unlocking the vehicle.
- If you select **Driver's door**, only the driver's door will be unlocked. To unlock all doors and the luggage compartment lid, press the  button on the vehicle key twice. In vehicles with a convenience key*, only the driver's door will unlock when you pull the driver's door handle. If you pull another door handle, the entire vehicle will be unlocked.

The entire vehicle will always be locked if you press the  button. ▶

¹⁾ Applies to: vehicles with anti-theft alarm system

Long press to open windows

You can select if all windows and the panoramic glass roof* should open using the vehicle key ⇒ *page 50, Convenience opening and closing*. If you press and hold the  button on the vehicle key, all of the windows and the panoramic glass roof* will close.

Disable rear lid handle

You can select if the luggage compartment lid can open with the handle ⇒ *page 46, fig. 30*. If you activate this function, the luggage compartment lid can only be opened with the  button on the vehicle key or in the driver's door. In vehicles with a convenience key*, you can still open the luggage compartment lid using the handle if an authorized convenience key is detected ⇒ *page 45*.

Fold mirrors

You can select if the exterior mirrors automatically fold in when locking.

Tone when locking¹⁾

You can select if an audio signal sounds when locking the vehicle.

Open with convenience key



Applies to: vehicles with convenience key

You can deactivate the feature for unlocking using the sensor. The function for locking via the sensor will still be enabled ⇒ *page 43*.

Central locking switch



Fig. 22 Driver's door: central locking switch

- ▶ To lock or unlock the vehicle, press the  or  button ⇒ .

When locking the vehicle with the central locking switch, the following applies:

- The doors and the luggage compartment lid cannot be opened from the outside for security reasons, for example, to reduce the risk of unauthorized entry while stopped at a light.
- The LED in the central locking switch turns on when all doors are closed and locked.
- You can open the doors individually from the inside by pulling the door handle one time. To open the rear doors individually, you must pull the door handle twice.
- In the event of a crash with airbag deployment, the doors unlock automatically to allow access to the vehicle.

WARNING

- Observe the safety precautions ⇒ *page 37*.
- The central locking button works when the ignition is switched off.
- The central locking switch is inoperative when the vehicle is locked from the outside.

Messages

The following messages may appear depending on the vehicle equipment:

 **Driver's door: malfunction! Shift to P before leaving vehicle. See owner's manual**

There is a malfunction in the driver's door. Secure the vehicle before exiting by selecting the "P" selector lever position. Drive immediately to an authorized Audi dealer or authorized Audi Service Facility to have the malfunction repaired.

 **Central locking: malfunction! See owner's manual**

There is a central locking malfunction. If the doors cannot lock, you can emergency lock the doors ⇒ *page 41*. Drive to an authorized Audi dealer or authorized Audi Service Facility immediately to have the malfunction corrected. ▶

¹⁾ This function is not available in all countries.

Please check the rear seats!

If you opened a rear door before you started driving, a message at the end of the trip will remind you that someone may still be in the rear seat. Before exiting the vehicle, check to make sure that no one is left behind in the vehicle, especially children and animals.

Door lock: opening while driving is only possible with the emergency release. See owner's manual

It is not possible to power unlock the doors at speeds above approximately 9 mph (15 km/h). If you must open doors at higher speeds in cases of emergency, you can manually unlock the door by forcefully pulling the door handle beyond its noticeable resistance two times. Then press the door handle back into its original position, if necessary.

Opening the door

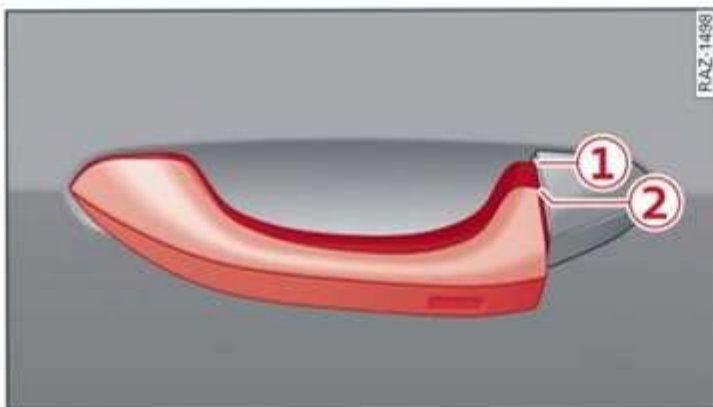

Fig. 23 Door handle: ① standard operation, ② emergency operation

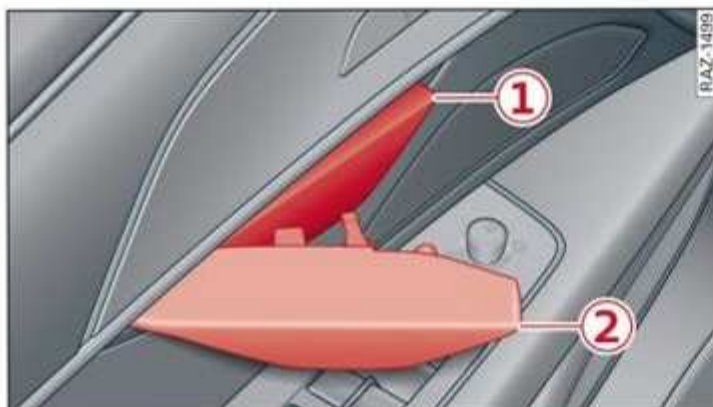

Fig. 24 Door handle: ① standard operation, ② emergency operation

side). The door lock is designed with two positions. For the standard operation pull the door handle to the first position, the second position is only intended for emergency operation.

Opening the door from outside

- ▶ Unlock the vehicle if necessary ⇒ *page 43*.
- ▶ Only slightly pull out the door handle to the first position ① ⇒ *fig. 23*, otherwise the door might not open as intended.

Opening the door from inside

- ▶ Only slightly pull the door handle towards the inside to the first position ① ⇒ *fig. 24*, otherwise the door might not open as intended.

Opening the door in an emergency

There is the option of emergency opening the door if the power door lock malfunctions.

- ▶ To open the door from the outside, pull the handle once or twice, overcoming the resistance to reach the second position ② ⇒ *fig. 23*.
- ▶ To open the door from the inside, it can be unlocked by pulling on the handle once or twice, overcoming the resistance to reach the second position ② ⇒ *fig. 24* and then be opened by pulling to the second position an additional time. Then press the door handle back into its original position, if necessary.

WARNING

Before opening the doors from the inside, you and any other persons in the vehicle should always check the traffic situation and the area around the vehicle with direct eye contact. Do not allow yourself to be distracted when checking around the vehicle.

Tips

Applies to: vehicles with exit warning system

For vehicles with an exit warning, opening the door can get delayed slightly. See ⇒ *page 165*.

Tips

– If you pulled the door handle on the inside or outside to the second stage without

intention to do so, then the door might not open correctly. Proceed as follows:

- Outside door handle: once again, slightly pull the door handle once or twice out to the first position ① ⇒ fig. 23.
- Inside door handle: once again, slightly pull the door handle once or twice to the second position ② ⇒ fig. 24.

Mechanically unlocking and locking the doors

All doors must be unlocked or locked separately if the central locking system fails.

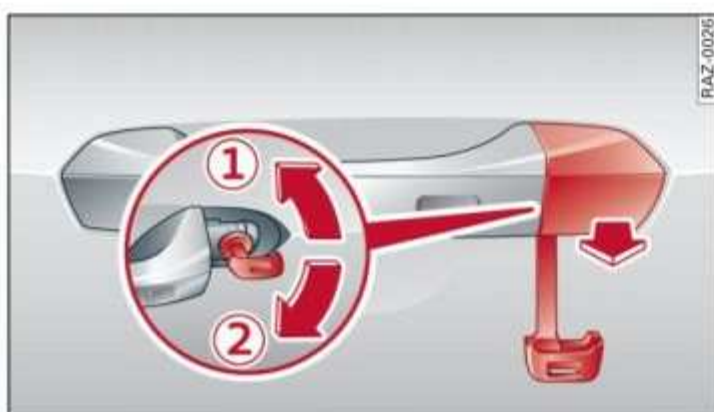



Fig. 25 Driver's door: door lock cylinder



Fig. 26 Door: mechanically locking

Applies to: vehicles with anti-theft alarm system: After unlocking using the lock cylinder and opening the driver's door, you must press the  button on the vehicle key or switch the ignition on. Otherwise the alarm will sound. When mechanically locking the doors, the anti-theft alarm will not be activated.

Unlocking or locking the driver's door with the mechanical key

- ▶ Remove the mechanical key ⇒ page 42.
- ▶ Insert the mechanical key into the slot under the door handle and pry the cap off ⇒ fig. 25.

- ▶ To unlock the driver's door, turn the mechanical key to the unlock position in the direction of arrow ① ⇒ fig. 25.
- ▶ Pull firmly on the door handle to open the driver's door. The door handle swings out slightly farther than normal.
- ▶ To lock the driver's door, select the "P" selector lever position, close the door, and turn the key once to the close position ② ⇒ .

Locking the front passenger's door and rear doors using the mechanical key

The mechanical lock is located on the edge of the doors. It is only visible when the door is open.

- ▶ Remove the mechanical key ⇒ page 42.
- ▶ If necessary, remove the cap from the opening ⇒ fig. 26.
- ▶ Insert the mechanical key into the slot on the inside and turn it all the way to the left (when locking the right door), or to the right (when locking the left door).
- ▶ If necessary, install the cap in the opening and close the door.

Once the doors are closed, it is no longer possible to open them from the outside. The front doors can be opened from the inside by pulling the door handle one time. The rear doors can be unlocked from the inside by pulling the door handle one time and then opened by pulling the door handle again. If the vehicle is without power, the doors can be unlocked from the inside by first pulling the door handle beyond its noticeable resistance. The doors can then be opened by pulling the handle again. Then press the door handle back into its original position, if necessary. If the child safety lock in one of the rear doors is activated, you must first pull the door handle from the inside. Then you can open the door from the outside.



WARNING

Observe the safety precautions ⇒ page 37.

Anti-theft alarm system

Applies to: vehicles with anti-theft alarm system

If the anti-theft alarm system detects a vehicle break-in, audio and visual warning signals are ▶

triggered. The anti-theft alarm system is switched on or off when locking or unlocking your vehicle. If the alarm is triggered, it will shut off automatically after a certain amount of time.

Switching the alarm off manually

- ▶ To switch the alarm off, press the  button on the vehicle key or switch the ignition on.

Depending on the vehicle equipment, the anti-theft alarm system may have the following features:

Break-in security feature

The alarm will be triggered if the doors, the hood, or the luggage compartment lid are broken into, or if a door that was previously unlocked using the lock cylinder is opened.

Interior/towing protection monitor

The alarm will be triggered if there are movements detected in the vehicle interior (for example, by animals) or if there is a change in the vehicle angle (for example, when the vehicle is being towed).

You can prevent the alarm from being triggered by deactivating the interior/towing protection monitor.

Deactivating the interior/towing protection monitor

There are the following options for deactivating the interior/towing protection monitor:

- ▶ Press the  button on the vehicle key a second time **within two seconds**. Or
- ▶ Applies to: vehicles with convenience key: Touch the sensor on the door handle a second time **within two seconds**. Or
- ▶ Turn the mechanical key in the door lock to the close position a second time **within two seconds**. Or
- ▶ Applies to: vehicles with MMI: Select on the home screen: **VEHICLE > Settings & Service > Interior monitoring**.

If you lock the vehicle, then the interior/towing protection monitor will stay off until the next time the vehicle is unlocked.

Tips

The interior/towing protection monitor only functions correctly when the windows and the panorama glass roof* are closed.

Keys

Key set



Fig. 27 Your vehicle key set

The key set includes two vehicle keys when delivered from the factory.

Vehicle key

You can unlock and lock your vehicle with the vehicle key.

Mechanical key and release button for mechanical key



A mechanical key is integrated in the vehicle key. To remove it, press the release button and remove the mechanical key.

Using the mechanical key, you can:

- Lock or unlock the glove compartment.
- Manually unlock and lock the doors ⇒ [page 41](#).
- Unlock the luggage compartment lid using the manual release ⇒ [page 48](#).

PANIC button

In an emergency, you can press the PANIC button to trigger a visible and audible vehicle alarm. You can do this as long as you are near your vehicle (within the range for the remote control key).

- To trigger the alarm, press the  button ⇒ [fig. 27](#).
- To turn the alarm off, press the  button again.

Lost key/replacing a key

If a vehicle key is lost, contact an authorized Audi dealer or authorized Audi Service Facility. Have this vehicle key deactivated. It is important to bring all keys with you.

If a key is lost, you should report it to your insurance company.

Electronic immobilizer

The immobilizer prevents unauthorized use of the vehicle.

In some cases, it may not be possible to establish vehicle drive ready mode if there is also a vehicle key from a different vehicle manufacturer on the key chain.

Data in the vehicle key

When driving, service and maintenance-relevant data is continuously stored in your vehicle key. An authorized Audi dealer or authorized Audi Service Facility can read out this data and tell you about the work your vehicle needs.

WARNING

Observe the safety precautions ⇨ *page 37*.

Note

Protect the key against high temperatures and direct sunlight.

For the sake of the environment

 Batteries and electrical/electronic devices must be disposed of in an environmentally safe manner ⇨ *page 325, Disposal instructions*.

Tips

- The vehicle key function can be temporarily disrupted by interference from transmitters near the vehicle working in the same frequency range (such as a mobile device or radio equipment). Always check if your vehicle is locked.
- Applies to MMI: You can view the number of keys programmed to the vehicle by select-

ing on the home screen: **VEHICLE > Settings & Service > Vehicle information**.

- A key tag that contains information about the vehicle key set may be attached to the key set at the factory. The key tag can be used to reorder vehicle keys. Keep the key tag. If you sell the vehicle, give the key tag to the buyer.
- The system complies with United States FCC regulations and ISED regulations ⇨ *page 325*.

Unlocking and locking the vehicle

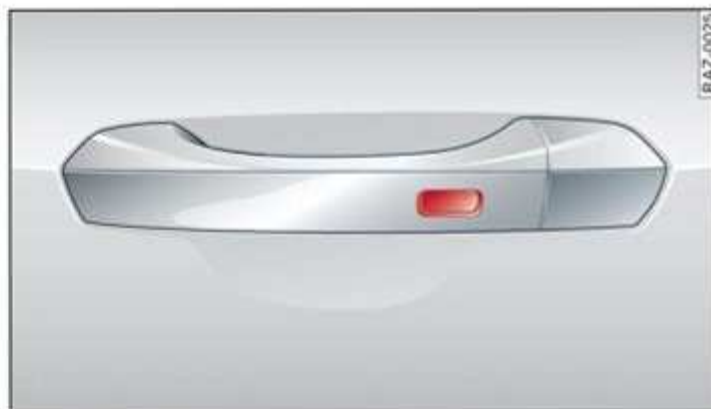



Fig. 28 Door handle: sensor for locking

Depending on the vehicle equipment, you may have various options for unlocking and locking your vehicle. The settings in the MMI specify which doors will unlock ⇨ *page 38*.

Unlocking or locking using the vehicle key buttons

- ▶ To unlock the vehicle, press the  button ⇨ *page 42, fig. 27*.
- ▶ To lock the vehicle, press the  button **once**.

Unlocking or locking using the sensors

Applies to: vehicles with convenience key

- ▶ To unlock a door or the luggage compartment lid, grasp the door handle or luggage compartment lid handle.
- ▶ To lock the vehicle, close the door and touch the sensor on the door handle **once** ⇨ *fig. 28*. Do not grasp the door handle while locking the vehicle, or else the vehicle will not lock. The door cannot be opened for a brief period directly after locking it. This way you have the opportunity to check if the doors locked correctly. ▶

Unlocking and locking with the Audi connect vehicle control service¹⁾

Applies to: vehicles with Audi connect vehicle control

Requirement: Audi connect vehicle control services must be set up ⇒ *page 207*. The vehicle must be parking and the ignition must be switched off.

WARNING

Observe the safety precautions ⇒ *page 37*.

Tips

- Only use the vehicle key when you can see the vehicle.
- The vehicle can only be locked when the "P" selector lever position is engaged.
- Do not use the vehicle key to lock and unlock when you are inside the vehicle. Otherwise, you could trigger the anti-theft alarm*. If this happens, press the  unlock button.

Tips

Applies to: vehicles with convenience key

- When unlocking or locking the vehicle, the convenience key cannot be more than approximately 4 feet (1.5 m) away from the door handle or luggage compartment.
- Unlocking with the convenience key (keyless access) can be deactivated in the MMI system ⇒ *page 38*.
- To prevent the vehicle battery from discharging, the energy management gradually switches off convenience functions that are not needed. You then may no longer be able to unlock your vehicle with the sensors.

LED and battery in the vehicle key



Fig. 29 Vehicle key: removing the battery holder

LED in the vehicle key

The LED  indicates the vehicle key function.

- ▶ If you press a button briefly, the LED blinks once.
- ▶ If you press and hold a button (convenience opening/closing), the LED blinks several times.
- ▶ If the LED does not blink, the vehicle key battery is drained. Replace the battery in the vehicle key.

Replacing the vehicle key battery

The replacement battery in the remote control key must meet the same specifications as the original battery (battery type **CR 2032**).

- ▶ Remove the mechanical key ⇒ *page 42* and insert it at an angle into the opening ⇒ *fig. 29*.
- ▶ Push the mechanical key in the opening in the direction of the arrow to operate the release button on the inside . To reduce the risk of damage, do not try to pry off the cover.
- ▶ Remove the cover from the battery tray.
- ▶ Insert the new battery with the "+" symbol facing up.
- ▶ Close the battery tray with the cover.
- ▶ Insert the mechanical key.

If the  indicator light appears with a corresponding message, the vehicle key battery is drained and must be replaced. ▶

¹⁾ In certain countries.

! WARNING

If batteries or coin cell batteries are swallowed or enter the body in any other way, they can cause serious or fatal injuries within a short period of time. There is a risk of chemical burns.

- Keep vehicle keys and key fobs with batteries out of the reach of children.
- Keep new or used batteries away from children.
- If the battery compartment on a vehicle key does not close securely, stop using the key and keep it away from children.
- Seek medical attention immediately if you suspect that a battery was swallowed or has entered the body in any other way.

♻️ For the sake of the environment

♻️ Batteries and electrical/electronic devices must be disposed of in an environmentally safe manner ⇒ *page 325, Disposal instructions.*

Luggage compartment lid**General information****! WARNING**

- No one, especially children, should stay in the vehicle when it is locked from the outside, because the windows can no longer be opened from the inside. Locked doors make it more difficult for emergency workers to enter the vehicle, which puts lives at risk.
- Always close and lock the luggage compartment lid and the doors when the vehicle is not in use. Otherwise someone such as a child could enter the vehicle through the luggage compartment and become locked inside it. To reduce the risk of injury, do not allow children to play in or around the vehicle.

- To reduce the risk of injuries by pinching, make sure that no one is in the operating area of the luggage compartment lid when closing, especially near the hinges, at the upper and lower edges of the lid, or all around the edge of the lid in general.
- After closing the luggage compartment lid, make sure that it is latched. The luggage compartment lid could open suddenly while driving, which would increase the risk of an accident.
- Never drive with the luggage compartment lid ajar or open, because poisonous gases from the surrounding area can enter the vehicle interior and increase the risk of asphyxiation.
- If there is a luggage rack (such as a bicycle rack) on the luggage compartment lid, the luggage compartment lid may not open completely under certain circumstances or it could close by itself if open due to the extra weight. Therefore, the open luggage compartment lid must be given additional support or the cargo must first be removed from the luggage rack.
- Applies to: vehicles with power-operated or sensor-controlled luggage compartment lid: ¹⁾ Pay careful attention when closing the luggage compartment lid. Otherwise, you could cause serious injury to yourself or others despite the pinch protection.

i Tips

- When the vehicle is locked, the luggage compartment lid can be unlocked separately by pressing the  button twice on the vehicle key. The luggage compartment lid locks automatically when it is closed again.
- The ability to open the luggage compartment lid using the handle ⇒ *page 46, fig. 30* can be deactivated or activated in the MMI ⇒ *page 38*.
- The luggage compartment can be opened from the inside in an emergency ⇒ *page 48*.

¹⁾ Not available in all countries.

Opening and closing the luggage compartment lid



Fig. 30 Rear lid: handle



Fig. 31 Driver's door: opening the luggage compartment lid

Opening the luggage compartment lid

- ▶ Unlock the vehicle or the luggage compartment lid using the / button on the vehicle key and press the handle in the luggage compartment lid \Rightarrow fig. 30. Or
- ▶ Applies to: vehicles with convenience key: Press the handle in the luggage compartment lid \Rightarrow fig. 30. When the luggage compartment is locked, the vehicle key cannot be more than approximately 4 feet (1.5 m) away from the luggage compartment. Or
- ▶ Applies to: vehicles with automatic luggage compartment lid: Select the "P" selector lever position and pull the \Rightarrow fig. 31 button in the driver's door.

Closing the luggage compartment lid

- ▶ Applies to: vehicles without automatic luggage compartment lid: Use the inside handle* to pull the luggage compartment lid down and allow it to drop gently into the latch to close it. Or
- ▶ Applies to vehicles with automatic luggage compartment lid: Note \Rightarrow page 46.

WARNING

Observe the safety precautions \Rightarrow page 45.

Automatic luggage compartment lid

Applies to: vehicles with automatic luggage compartment lid

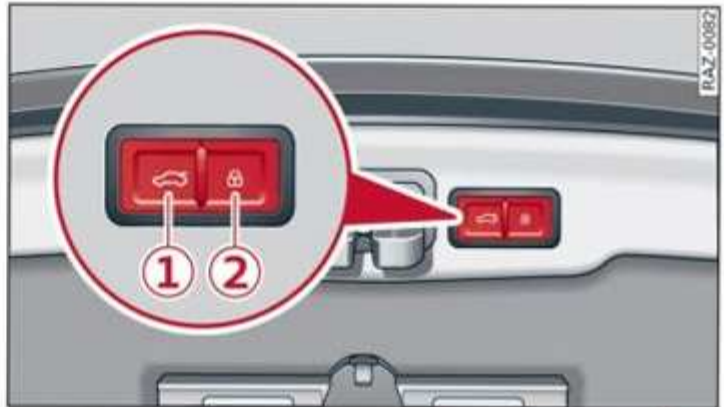

Fig. 32 Luggage compartment lid: ① closing button*, ② lock button* (vehicles with convenience key*)

The luggage compartment lid can be opened and closed automatically \Rightarrow in *General information* on page 45.





Opening the luggage compartment lid

- ▶ When the ignition is switched off, press the button on the vehicle key twice \Rightarrow page 42, fig. 27. Or
- ▶ Engage the "P" selector lever position and pull the button* in the driver's door. Or
- ▶ Applies to: vehicles with convenience key: Press the handle in the luggage compartment lid ① \Rightarrow page 46, fig. 30. When the luggage compartment is locked, the vehicle key cannot be more than approximately 4 feet (1.5 m) away from the luggage compartment.

Closing the luggage compartment lid



- ▶ Press the button in the luggage compartment lid. Or
- ▶ Press the handle in the luggage compartment lid \Rightarrow page 46, fig. 30. Or
- ▶ Press the luggage compartment lid downward slightly. Or
- ▶ When the ignition is switched on, pull the switch in the driver's door \Rightarrow page 46, fig. 31 until the luggage compartment lid is closed. Or
- ▶ Applies to: vehicles with convenience key: Press and hold the button on the vehicle key while the ignition is switched off until the luggage \blacktriangleright

compartment lid closes. Make sure there is enough distance (maximum of approximately 9 feet (3 m)) between you and the luggage compartment lid. Or

- ▶ Press the  button in the luggage compartment lid. Or
- ▶ Applies to: vehicles with convenience key: When the ignition is switched off, press the  /  button in the luggage compartment lid. The vehicle key must not be more than approximately 4 feet (1.5 m) away from the luggage compartment and it must not be inside the vehicle. If you press the * button, then the vehicle will lock.

Stopping automatic opening or closing

The automatic opening or closing of the luggage compartment lid will stop if:

- ▶ You press the  button or press the handle in the luggage compartment lid again ⇒ *page 46, fig. 30*. Or
- ▶ You press the * button on the convenience key*. Or
- ▶ Something blocks the luggage compartment lid or makes it difficult for the lid to move.

If you press the button  or the handle in the luggage compartment lid ⇒ *page 46, fig. 30* again, the luggage compartment lid will open or close again.

Manually opening and closing the luggage compartment lid

If the electric motor malfunctions or the vehicle battery charge level is low, the luggage compartment lid can be opened or closed by hand. Extra force will be needed to do this. Move the lid slowly to reduce the amount of force needed.

- ▶ Pull the luggage compartment lid down slightly by the inside handle* and then press on the lid until it latches.

WARNING

Observe the safety precautions ⇒ *page 45*.

Tips

If the luggage compartment lid is open while the vehicle key is inside the luggage compartment or the passenger compartment, then the * button on the luggage compartment lid will be disabled.

Opening and closing the luggage compartment lid with foot motion¹⁾ (kicking movement)

Applies to: vehicles with sensor-controlled luggage compartment lid



Fig. 33 Vehicle rear: foot motion (example)

The luggage compartment lid can be opened and closed automatically²⁾ ⇒  in *General information on page 45*.

Requirements: you must be carrying your convenience key* with you. The ignition must be switched off. You must be standing at the center behind the luggage compartment lid. Depending on vehicle equipment, it may also be possible to stand slightly off-center at the back of your vehicle.

- ▶ Move your foot back and forth under the bumper one time ⇒ *fig. 33*. Do not touch the bumper. Make sure you have firm footing. The luggage compartment lid will open or close²⁾ once the system detects the movement. The automatic opening or closing will be canceled if you repeat one of the movements described.

WARNING

Observe the safety precautions ⇒ *page 45*.

¹⁾ Not available in all countries.

²⁾ The closing function applies to vehicles that also have automatic luggage compartment lid operation.

WARNING

Please note that when you have the convenience key with you, the sensor-controlled luggage compartment lid could open or close unexpectedly during activity near the rear of the vehicle. This increases the risk of an accident.

Note

Please note that when you have the convenience key with you, the sensor-controlled luggage compartment lid could open or close unexpectedly during activity near the rear of the vehicle (for example, the lid could hit the ceiling in a garage).

Tips

The luggage compartment lid will only open or close ¹⁾ if you perform the movement as described. This prevents the luggage compartment lid from opening or closing due to similar movements ¹⁾, such as when you walk between the rear of the vehicle and your garage door. In some situations, the function may be limited or temporarily unavailable. This may happen if:

- You are standing too close to the bumper or too far away from it
- The luggage compartment lid was closed or opened immediately beforehand
- You park close to a hedge and the branches move back and forth under the vehicle for a long period of time
- You clean your vehicle, for example with a pressure washer or in a car wash
- There is heavy rain
- The bumper is very dirty, for example after driving on salt-covered roads
- There is interference to the vehicle key's radio signal, such as from mobile devices or remote controls
- If the vehicle key is located in the luggage compartment or passenger compartment while the luggage compartment lid is open,

then it will not be possible to close the luggage compartment lid using foot motions.

Manually unlocking the luggage compartment lid



Fig. 34 Luggage compartment lid: mechanical key in lock cylinder

- ▶ Remove the integrated mechanical key
⇒ page 42.
- ▶ Insert the mechanical key in the luggage compartment lid lock cylinder.
- ▶ Turn the key counterclockwise. The luggage compartment lid opens.

WARNING

Observe the safety precautions ⇒ page 45.

Opening the luggage compartment lid from the inside in an emergency



Fig. 35 Inner luggage compartment lid: lever

- ▶ Press the lever in the direction of the arrow until the luggage compartment lid opens.

¹⁾ The closing function applies to vehicles that also have automatic luggage compartment lid operation.

Child safety lock

The child safety lock prevents the rear doors from being opened from the inside and the rear power windows from being operated.



Fig. 36 Driver's door: controls

- ▶ To activate or deactivate the child safety lock for the rear doors (which controls the power windows and interior door handle), press the left and/or right  button in the driver's door ⇒ fig. 36. The LED in the button will turn on or off.
- ▶ Make sure the child safety lock is working by checking the function on the rear power window switch and door handle.
- ▶ Applies to: vehicles with controls for the climate control system in the rear and MMI: To also restrict the operation of the climate control system in the rear, select on the home screen: **SETTINGS > Display & Brightness > Operation in rear**

When the child safety lock is switched on, the following functions are disabled:

- The rear inner door handles
- The rear power windows
- The control panel* for the climate control system in the rear
- The buttons in the rear for the sunshades*
- The button for the front passenger's seat adjustment* (when the child safety lock is activated for the rear door on the front passenger's side)
- The buttons for the power-adjustable rear seats*
- Rear Seat Remote* ⇒ page 29

Message in the instrument cluster display

The following messages may appear depending on the vehicle equipment:

/ Child safety lock: malfunction! Please contact Service

There is a malfunction in the child safety lock. Press the  button again.

If the message stays on, drive immediately to an authorized Audi dealer or authorized Audi Service Facility to have the malfunction repaired.

WARNING

- Observe the safety precautions ⇒ page 37.
- A malfunction in the child safety lock could allow the rear doors to be opened from the inside, which increases the risk of an accident.

Power windows

Opening and closing windows and sunshades

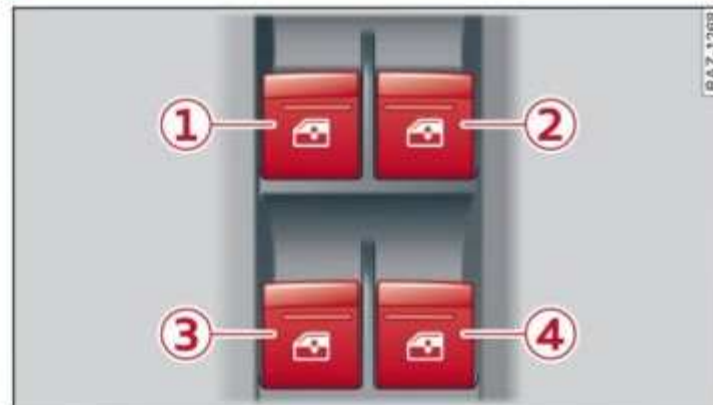

Fig. 37 Driver's door: power window switch

Power window switches:

- ① Left front door
- ② Right front door
- ③ Left rear door
- ④ Right rear door

Opening and closing the windows

All power window switches are equipped with a two-stage function:

- ▶ To open or close the window completely, press the switch down or pull the switch up briefly to ▶



the second level. The operation will stop if the switch is pressed or pulled again.

- ▶ To select a position in between opened and closed, press or pull the switch to the first level until the desired window position is reached.

Opening or closing sunshades on the rear side windows

Applies to: vehicles with power sunshades on the rear side windows

Requirement: the window whose sunshade you will operate must be closed.

- ▶ To close or open the sunshade from the driver's seat, pull or press the respective  power window switch in the driver's door.
- ▶ To close or open the sunshade from the rear, pull or press the respective  power window switch in the rear door.
- ▶ Applies to: Rear Seat Remote: To close or open the sunshade from the rear, select on the home screen: **BLINDS**.

Correcting a malfunction in the one-touch up/down function

If necessary, you can reactivate the one-touch up/down function if it malfunctions.

- ▶ Pull the power window switch up until the window is completely raised.
- ▶ Release the switch and pull it up again for at least one second.

WARNING

- Observe the safety precautions ⇨ *page 37*.
- Never close the windows or sunshades* carelessly or in an uncontrolled manner, because this increases the risk of injury.

Tips

- You can still open and close the windows for several minutes after turning the ignition off. The power window switch is not disabled until the driver's door or front passenger's door is opened.
- The power windows are equipped with pinch protection. The automatic window may stop closing and will open all the way again even if no obstacle is detected. Pull the power



window switch up until the window is completely raised.

Convenience opening and closing

Applies to: vehicles with convenience key

Convenience opening or closing the windows or panoramic glass roof*

You can set in the MMI if all windows and the roof* should open all at once ⇨ *page 38, Setting the central locking system*.



- ▶ Press and hold the  or  button on the vehicle key until all windows and the roof* have reached the desired position ⇨ . Or
- ▶ Touch the sensor* on the door handle ⇨ *page 43, fig. 28* until all of the windows and the roof* are closed. Do not place your hand in the door handle when doing this.

When all of the windows and the roof* are closed, the turn signals will flash once.



Convenience opening and closing the sunshade*

Applies to: vehicles with power sunshade

You can open or close all of the sunshades at once.

- ▶ Press and hold  on the lower display. Or
- ▶ Press and hold the  button in the rear door.
- ▶ Applies to: Rear Seat Remote: Select on the home screen: **BLINDS**. Press on the picture of the sunshade to operate it.

WARNING

- Observe the safety precautions ⇨ *page 37*.
- Never close the windows or panoramic glass roof* carelessly or in an uncontrolled manner, because this increases the risk of injury.
- For security reasons, the windows and the panoramic glass roof* can only be opened and closed with the vehicle key at a maximum distance of approximately 6.5 feet (2 m) from the vehicle. Always pay attention when using the  button to close the windows and the panoramic glass roof* so that no one is pinched. The closing process will stop immediately when the  button is released.

i Tips

Applies to: vehicles with panoramic glass roof: If the sunshade is closed, it will automatically open when the roof is tilted.

Panoramic glass roof**Operating the panoramic glass roof and roof sunshade**

Applies to: vehicles with panoramic glass roof and roof sunshade

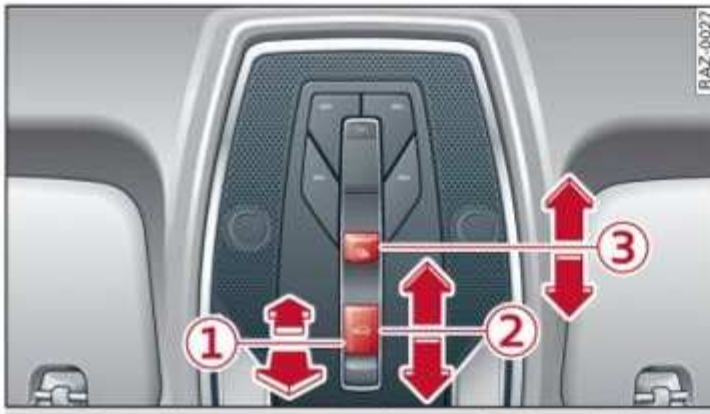

Fig. 38 Headliner: panoramic glass roof and sunshade* buttons

The control buttons are equipped with a two-stage function. Depending on the equipment, it may also be possible to operate the roof and the roof sunshade from the rear.

If the sunshade is closed, it will automatically open when the roof is tilted or opened.

Operating the front roof sunshade

The roof sunshade cannot be closed completely if the roof is open.

- ▶ Opening and closing the sunshade: push the switch in the headliner ② briefly toward the rear or forward to the second level. Or: push or pull the switch in the rear briefly downward or upward to the second level.
- ▶ Partially opening the sunshade: press the switch to the first level until the sunshade reaches the desired position.

Operating the rear roof sunshade*

- ▶ Opening and closing the sunshade: push the switch in the headliner ③ briefly forward or toward the rear to the second level. Or

- ▶ Push or pull the switch in the rear door briefly downward or upward to the second level.
- ▶ Partially opening the sunshade: press the switch to the first level until the sunshade reaches the desired position. Or
- ▶ Applies to: Rear Seat Remote: Select on the home screen: **BLINDS**. Press on the picture of the sunshade to operate it.

Operating the roof from the cockpit



- ▶ Tilting the roof: press the switch in the headliner briefly up to the second level ①.
- ▶ Closing the tilted roof: pull the switch down briefly to the second level.
- ▶ Applies when the sunshade is open: Opening the roof: push the button toward the rear briefly to the second level ②.
- ▶ Closing the opened roof: push the switch forward briefly to the second level.
- ▶ Applies when the sunshade is open: Opening partially: push, press, or pull the switch to the first level until the roof reaches the desired position.
- ▶ Applies to: Rear Seat Remote: Select on the home screen: **BLINDS**. Press on the picture of the roof to operate it.

Operating the roof from the rear*

- ▶ Tilting the roof: briefly press the switch* in the rear door downward once to the second level.
- ▶ Closing the tilted roof: pull the switch* upward briefly to the second level.
- ▶ Applies when the blinds are open: opening the roof: Press the switch* in the rear door downward again briefly to the second level.
- ▶ Closing the roof: pull the switch* upward briefly to the second level.
- ▶ Applies when the blinds are open: opening partially: Pull or press the switch* to the first level until the roof reaches the desired position.
- ▶ Applies to: Rear Seat Remote: Select on the home screen: **BLINDS**. Press on the picture of the roof to operate it.

Quick opening and closing

You can also open or close the roof and front sunshade from the cockpit in one movement. ▶

- ▶ Opening the roof and sunshade: slide the  switch back briefly twice in a row to the second level ②.
- ▶ Closing the opened roof and sunshade: push the  switch forward briefly twice in a row to the second level.

If necessary, you can interrupt the quick opening or closing process by pressing the button again.

Roof emergency closing

If an object is detected when closing, the roof will open again automatically. In this case, you can then close it with the power emergency closing function.

- ▶ Within five seconds after the sunroof opens automatically, pull the applicable button until the roof is closed.

WARNING

- Observe the safety precautions ⇒ page 37.
- To reduce the risk of injury, always pay attention when closing the roof. Always switch the ignition off and take the key with you when leaving the vehicle.

Note

Always close the roof when you leave the vehicle and when there is precipitation to reduce the risk of damage to the interior equipment, particularly the electronic equipment.

Tips



- After switching off the ignition, the roof and sunshades can still be operated for several minutes as long as neither of the front doors have been opened.
- It is not possible to open the roof when temperatures are too low.

Opening and closing the rear window sunshade

Applies to: vehicles with a sunshade on the rear window

The sunshade on the rear window can be operated both from the cockpit and from the rear seats.

Operating the sunshade on the rear window

- ▶ Applies to: MMI: Opening or closing the sunshade: press the  button on the lower display. Or
- ▶ Press the  button briefly in the rear door.
- ▶ Applies to: Rear Seat Remote: Select on the home screen: **BLINDS**. Press on the picture of the rear window sunshade to operate it.

WARNING

Observe the safety precautions ⇒ page 37.

Valet parking

Applies to: vehicles with valet parking function

The valet parking function can protect the luggage compartment from unauthorized access.



The  button for valet parking is in the glove compartment.

You can switch the valet parking function on, for example when someone else is parking your vehicle ¹⁾. The vehicle can be driven, locked, and unlocked using the vehicle key, but access to the luggage compartment is blocked.

- ▶ Remove the mechanical key ⇒ page 42.
- ▶ Press the  button in the glove compartment. The LED in the button turns on if the function is switched on.
- ▶ Lock the glove compartment with the mechanical key.
- ▶ Give your vehicle key to the service personnel who are parking your vehicle and keep the mechanical key.

If the  indicator light appears with a corresponding message, the vehicle key battery is drained and must be replaced.

The following buttons are deactivated when the valet parking function is switched on:

-  Button in the driver's door
-  Button on the vehicle key
- Handle in the luggage compartment lid
⇒ page 46, fig. 30

¹⁾ This function is not available in all countries.

If the valet parking function is switched on, a message will appear every time the ignition is switched on.

Tips

Please note that the luggage compartment can still be accessed from the vehicle interior in vehicles with fixed rear seat backrests or ones that cannot be locked, even when the valet parking function is switched on.

Garage door opener

Description

Applies to: vehicles with garage door opener

With the garage door opener, you can activate systems such as the garage doors, security systems or house lights from inside your vehicle. These functions are operated in the MMI. Multiple receivers can be programmed, which can control the functions of up to eight¹⁾ hand-held transmitters.

WARNING

- When operating or programming the garage door opener, make sure that no people or objects are in the area immediately surrounding the equipment. People can be injured or property can be damaged if struck when closing.
- Do not allow yourself to be distracted from traffic by the viewing and operating the displays.

Tips

- If you sell your vehicle, reset all settings to the factory default settings ⇒ *page 247*.
- The system complies with United States FCC regulations and ISED regulations ⇒ *page 325*.

Tips

Before you program your system to the garage door opener, first check the compatibility:



- Ask an authorized Audi dealer or authorized Audi Service Facility or check at www.homelink.com. You can also find more information about HomeLink there.
- You can display information about HomeLink (compatibility level/status/country code/HomeLink generation) in the MMI:
- Select on the home screen: **VEHICLE** > **Settings & Service** > **Garage opener** > .

Operation

Applies to: vehicles with garage door opener

Requirements: the remote control transmitter must be programmed ⇒ *page 54, Programming*, the vehicle must be within range of the system, and the ignition must be switched on.

There are multiple options to open or close the system (such as the garage door).

- ▶ If you have only programmed one remote control transmitter, press the  button on the lower display. Or
- ▶ If you have programmed multiple remote control transmitters, press the  button on the lower display and then press the respective system button. Or
- ▶ Applies to: vehicles with programmable steering wheel button: If you have configured the programmable steering wheel button, press the  button ⇒ *page 33*. Or
- ▶ Applies to: vehicles with location pairing: If you have programmed **Location pairing**, press the button for this in the upper display (notification center ⇒ *page 25*). As you approach the system, the button is displayed on the MMI.

If transmission was successful, the message: **Send to: XXX** will appear.

¹⁾ The possible number of hand-held transmitters depends on the equipment.

Programming

Applies to: vehicles with garage door opener





You can program both fixed code and rolling code systems in the MMI using the procedure that is described.

Requirement: the ignition must be switched on.

Programming the system

Applies to: MMI

Requirement: the hand transmitter must be present and the vehicle must be within range of the system (such as the garage door) that you would like to program.

- ▶ If you are programming the garage door opener for the **first time**, press the  button on the lower display. Follow the instructions in the upper display. Or
- ▶ If you would like to program **other** systems, select on the home screen: **VEHICLE > Settings & Service > Garage opener**. Select the desired button: . Follow the instructions in the MMI.
- ▶ If you would like to **reprogram** systems that are already programmed, select on the home screen: **VEHICLE > Settings & Service > Garage opener**. Press the  button and select  for the system to be reprogrammed. Select: **Program**. Follow the instructions in the MMI.

With some systems, the garage door opener will be immediately available after programming. With other systems, the garage door opener must also be synchronized.

Synchronizing¹⁾

Requirement: the hand transmitter must already be programmed and the vehicle must be within range of the system (such as the garage door).

If the system synchronization is performed directly after the programming procedure, follow the instructions on the MMI.

If you would like to sync at a later time:

- ▶ Applies to: MMI: Select on the home screen: **VEHICLE > Settings & Service > Garage opener**.

- ▶ Press the button for the system that you would like to synchronize.
- ▶ Follow the instructions in the MMI.

Location pairing



Applies to: vehicles with location pairing

For easier operation, you can program your system's location.

Requirements: the respective hand transmitter must be programmed ⇨ *page 54* and the vehicle must be located in front of the system.

- ▶ If you have programmed your system, follow the instructions in the MMI. Or

If you would like to set up location pairing at another time:

- ▶ Applies to: MMI: Select on the home screen: **VEHICLE > Settings & Service > Garage opener**.
- ▶ Press the  button.
- ▶ Press the  button for the system your vehicle is facing.
- ▶ Select: **Location pairing**.
- ▶ Follow the instructions in the MMI.



Only a maximum of three systems can be displayed in the notification center ⇨ *page 25*. If you would like to have all systems displayed, press .

Renaming programmed systems

You can rename the programmed systems according to your preferences (names may have a maximum of 10 characters).

- ▶ If you have programmed your system, follow the instructions in the MMI. Or



If you would like to change the name at another time:

- ▶ Applies to: MMI: Select on the home screen: **VEHICLE > Settings & Service > Garage opener**.
- ▶ Press the  button.
- ▶ Press the  button for the system that you would like to rename.
- ▶ Select: **Rename**. If necessary, delete the preset name, such as Garage door opener 1.
- ▶ Follow the instructions in the MMI. ▶

¹⁾ Only applies to rolling code systems

Deleting programmed systems

The programmed systems can be deleted individually or all at once.

- ▶ Applies to: MMI: Select on the home screen: **VEHICLE > Settings & Service > Garage opener.**
- ▶ Press the  button.
- ▶ To delete an **individual** system, press the button for the desired system. If the checkmark  is set, select: **Delete.**
- ▶ To delete **all** systems, select: **All > Delete.**

Tips

- Make sure the batteries in the hand transmitter are charged before starting the programming process.
- The programming process may take up to 30 seconds. It may be necessary for the hand transmitter to be pressed again in the meantime.
- The garage door opener may need to be synchronized with the system after programming. Follow the manufacturer's instructions for doing this.

Tips

- In some cases, the system may need to be programmed in a different mode ("D mode").
- Switch the ignition on.
 - Applies to: MMI: Select on the home screen: **VEHICLE > Settings & Service > Garage opener.**
 - Press and hold the desired button .
 - Select **Yes, in D mode** and follow the instructions on the MMI.

Lights and vision

Exterior lighting

Switching the lights on and off

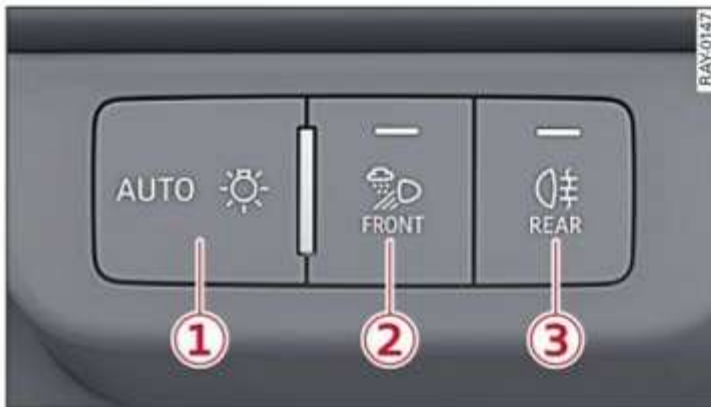





Fig. 39 Instrument panel: light button module

① Light switch

Press and hold ① until the desired light function is selected. The selected function is displayed briefly in the instrument cluster. When switching on the ignition, the AUTO light function is automatically selected.

- AUTO - The automatic headlights adapt to the surrounding brightness automatically. The daytime running lights will automatically turn on. In vehicles for certain markets, you can switch the automatic daytime running lights on and off in the MMI.
-  - You can switch the low beam headlights on manually once the ignition is switched on.
-  - You can switch the parking lights on at speeds below 20 mph (32 km/h).
- USA models: OFF - You can switch off all light functions at speeds under 6 mph (10 km/h).
- Canada models: OFF - You can switch off all light functions when the ignition is switched off while the vehicle is stationary.

When the low beam headlights or parking lights are switched on, the respective  or  indicator light appears in the instrument cluster.

② All-weather lights

The headlights automatically adjust so that there will be less glare, for example when the road surface is wet.

③ Rear fog lights

To reduce glare for traffic behind your vehicle, the rear fog lights should only be turned on in accordance with the legal regulations in the country where you are operating the vehicle.

Automatic headlight range control

Your vehicle is equipped with automatic headlight range control. It reduces glare for oncoming traffic if the vehicle load changes. The headlight range adjusts automatically.

Audi adaptive light

Applies to: vehicles with Audi adaptive light

Audi adaptive light provides better visibility when driving in the dark. The lights are adapted to the road conditions based on speed, such as when driving on expressways, rural roads, at intersections, and around curves. The adaptive light only functions when the automatic headlights are activated.

WARNING

- Observe the safety precautions and note the limits of the assist systems, sensors, and cameras ⇨ *page 127* to ⇨ *page 130*.
- Automatic headlights are only intended to assist the driver. The driver is still responsible for controlling the headlights and may need to switch them on and off manually depending on light and visibility conditions. For example, fog cannot be detected by the light sensors. So always switch on the low beams  under these weather conditions and when driving in the dark.

Tips

- If the vehicle battery has been discharging for a while, the parking light may switch off automatically. Avoid using the parking lights for several hours.
- When using lighting equipment, the driver is responsible for adhering to any local applicable regulations while driving and when parking the vehicle.
- Only the front headlights are on when the daytime running lights are switched on. In

vehicles in certain markets, the tail lights will also turn on.

- In cool or damp weather, the inside of the headlights, turn signals, and tail lights can fog over due to the temperature difference between the inside and outside. They will clear shortly after switching them on. This does not affect the service life of the lighting.
- When the parking lights are switched on and the ignition is switched off, the  symbol appears in the light switch module.

Turn signal and high beam lever

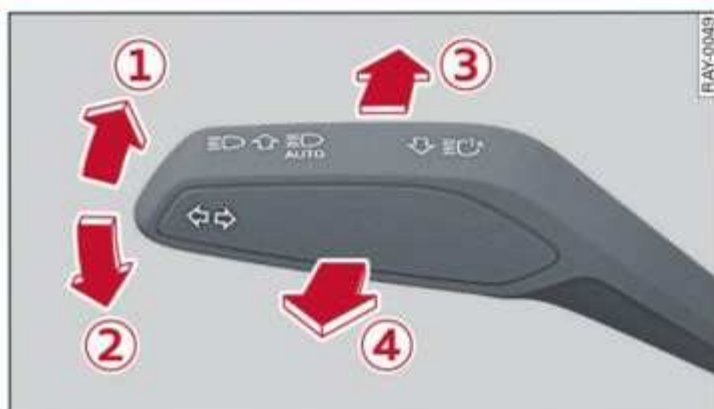



Fig. 40 Operating lever: switching the light functions on and off

The lever operates the turn signals, the high beams and the headlight flasher.

Turn signals

The turn signal will activate when you move the lever into a turn signal position while the ignition is switched on. The respective  or  indicator light flashes. The turn signal blinks three times if you tap the lever (convenience turn signal).

- ① Right turn signal
- ② Left turn signal

If an indicator light blinks twice as fast as usual, a turn signal bulb has failed. Carefully drive to an authorized Audi dealer or authorized Audi Service Facility immediately to have the malfunction corrected.

High beams and headlight flasher

► Move the lever to the corresponding position:

- ③ High beams on (high beam assistant \Rightarrow page 57)
- ④ High beams off or headlight flasher

The  indicator light in the instrument cluster will turn on.

WARNING

High beams can cause glare for other persons, which increases the risk of an accident. For this reason, only use the high beams or the headlight flasher when they will not create glare for other drivers.

High beam assistant

The high beam assistant automatically turns the high beams on or off depending on the surrounding conditions.

A camera on the rearview mirror mount can detect light sources from other road users. The high beams switch on or off automatically depending on the position of vehicles driving ahead and oncoming vehicles, the vehicle speed as well as other environmental factors and traffic conditions.

Applies to: vehicles with Matrix LED headlights: With Matrix LED headlights ¹⁾, individual segments of the high beams are turned on or off. The area in front of the vehicle is dimmed, while the remaining area is illuminated. This allows for optimal lighting of the surrounding area without causing glare for other road users.

Activating high beam assistant

Requirement: the AUTO light function must be selected and the high beam assistant must be switched on in the MMI \Rightarrow page 58.



- To activate the high beam assistant, tap the lever forward ③ \Rightarrow page 57, fig. 40. The  indicator light will appear in the instrument cluster display and the high beams will be switched on or off automatically. If the high beams were ►

¹⁾ Not available in all countries.

completely or partially switched on, the  indicator light will turn on.

Activating and deactivating the high beam head lights manually

If the high beams did not switch on or off as expected, you may switch them on or off manually instead:

- ▶ To activate the high beams manually, tap the lever forward  ⇒ *page 57, fig. 40*. The  indicator light will turn on.
- ▶ To deactivate the high beams manually, pull the lever back  ⇒ *page 57, fig. 40*. The high beam assistant is deactivated.

Operating the headlight flasher

- ▶ To operate the headlight flashers, pull the lever back  ⇒ *page 57, fig. 40*. If the high beam headlights are not switched on, the high beam assistant will remain activated.

WARNING

- Observe the safety precautions and note the limits of the assist systems, sensors, and cameras ⇒ *page 127 to ⇒ page 130*.
- High beam assistant is only intended to assist the driver. The driver is always responsible for controlling the high beam headlights and adjusting them based on the lighting and visibility conditions.
- High beams can cause glare for other persons, which increases the risk of an accident. For this reason, only use the high beams or the headlight flasher when they will not create glare for other drivers.

Tips

Adhere to any local applicable regulations when using the lighting equipment, for example in regard to reducing glare for other road users. The driver is always responsible for adhering to the regulations applicable in the country where the vehicle is being operated.

Adjusting the exterior lighting

The following settings depend on the vehicle equipment.

- ▶ Applies to: MMI: Select on the home screen: **VEHICLE > Light & Visibility > Exterior lighting**.

Automatic headlights

You can adjust the following settings in the **Automatic headlights** menu:

Activation time - You can adjust if the headlights switch on **Early**, **Medium**, or **Late** based on the sensitivity of the light sensor.

High beam assistant - You can switch the high beam assistant on and off.

Entry/exit lighting

The **Entry/exit lighting** illuminates the area around the vehicle when the vehicle is unlocked or when the driver's door is opened while the ignition is off. The entry/exit lighting works when it is dark and when the AUTO light function is switched on. The front and rear daytime running lights switch on automatically each time the vehicle is unlocked regardless of how bright it is outside the vehicle.

Applies to: vehicles with digital Matrix LED functions: The entry lighting also projects a light animation when the vehicle is unlocked and the driver's door is opened. The exit lighting also starts the light animation when the ignition is switched off. The light animation will appear on surfaces in front of the vehicle when it is dark. You can choose from various animations.

Daytime running lights

USA models: The daytime running lights can be switched on and off.

Canada models: The daytime running lights cannot be switched off. The lights activate automatically each time the ignition is switched on.

Digital light signatures

You can choose from various light signatures. The light signature is always active when the tail lights are active.

If you change to a different light signature, the change will go into effect shortly after you exit the vehicle.

Emergency flashers



Fig. 41 Center console: emergency flashers

The emergency flashers help to make other road users aware of your vehicle in dangerous situations.

- ▶ Press the button to switch the emergency flashers on or off.

When the emergency flashers are turned on, the and indicator lights will flash at the same time.

You can indicate a lane change or a turn when the emergency flashers are switched on by using the turn signal lever. The emergency flashers stop temporarily.

The emergency flashers also work when the ignition is turned off.

Tips

You should switch the emergency flashers on if:

- you are the last car in a traffic jam so that all other vehicles approaching from behind can see your vehicle
- your vehicle has broken down or you are having an emergency
- your vehicle is being towed or if you are towing another vehicle

Messages

The following messages may appear depending on the vehicle equipment:

If the indicator light turns on, a bulb has failed. The displayed message indicates the cause and possible solutions. If one of the messages re-

mains on, drive immediately to an authorized Audi dealer or authorized Audi Service Facility to have the malfunction repaired.

Audi adaptive light: malfunction! See owner's manual

Adaptive light is not working. The headlights still function. Drive immediately to an authorized Audi dealer or authorized Audi Service Facility to have the malfunction repaired.

Headlight range control: malfunction! See owner's manual

There is a malfunction in the headlight range control system, which may cause glare for other road users. Drive to an authorized Audi dealer or authorized Audi Service Facility immediately to have the malfunction corrected.

OLED tail light: malfunction! Switched off permanently. See owner's manual

Drive immediately to an authorized Audi dealer or authorized Audi Service Facility to have the malfunction repaired.

High beam assistant: malfunction! See owner's manual

You can still switch the high beams on or off manually. Drive immediately to an authorized Audi dealer or authorized Audi Service Facility to have the malfunction repaired.

High beam assistant: currently unavailable. Camera view limited due to surroundings. See owner's manual

This message appears if the camera's visual field is blocked. The system will switch itself off. Try switching the systems on later.

Automatic headlights: malfunction! See owner's manual

The light/rain sensor is malfunctioning. When the AUTO light function is on, the low beams will remain switched on at all times for safety reasons. Drive immediately to an authorized Audi dealer or authorized Audi Service Facility to have the malfunction repaired.

Interior lighting

Front interior lighting



Fig. 42 Headliner: interior lighting

Interior lighting buttons

* - Interior lighting on/off

* - Rear interior lighting on/off

 - Door contact switch on/off. The interior lighting is controlled automatically.

Touch-sensitive reading lights

- ▶ To turn a reading light on or off, touch the surface ① briefly.
- ▶ To activate the manual dimming function, touch the surface ① when the light is switched off and keep touching it until the desired brightness is reached.

Rear interior lighting



Fig. 43 Headliner: reading lights

Press the * button to switch the rear interior lighting on or off.

Touch-sensitive reading lights*

- ▶ To turn a reading light on or off, touch the surface ① briefly.

- ▶ To activate the manual dimming function, touch the surface ① when the light is switched off and keep touching it until the desired brightness is reached.

Matrix reading lights*

When the reading lights are switched on, you can adjust the brightness, position, and focus range.

- ▶ Applies to Rear Seat Remote: Select on the home screen: **LIGHTS > Matrix lights > Individual**.

Interior lighting

Applies to: vehicles with interior lighting

The ambient lighting turns on when the ignition is switched on. The interior lighting is deactivated when the lights are set to OFF.

The following settings depend on the vehicle equipment.

- ▶ Applies to MMI: Select on the home screen: **VEHICLE > Light & Visibility > Interior lighting**.
- ▶ Applies to Rear Seat Remote: Select on the home screen: **LIGHTS > Interior lighting**.

You can choose from various color profiles, such as **Maritime**.

Additional settings and profiles:

- **Brightness:** you can adjust the brightness for all of the interior lighting.
- **Individual:** you can adjust the brightness and color of the interior lighting separately for the line and surface lighting.
- **Audi drive select:** the contour and surface lighting color changes depending on the selected drive select* mode.

Tips

Depending on vehicle equipment, when the drive select* function is selected, the color of the contour and surface lighting may briefly change to red or blue when the interior temperature is manually increased or decreased.

Display brightness

You can set the instrument and display illumination. The settings depend on the vehicle equipment.

- ▶ Applies to MMI: select on the home screen: **SETTINGS > Display & Brightness**.
- ▶ Applies to Rear Seat Remote: select on the home screen: **SETTINGS > Device**.

Possible settings in the MMI:

- Cockpit dimming
- Head-up display
- MMI
- Audi virtual cockpit

Possible settings in the Rear Seat Remote:

- Brightness
- Dim display

Vision

Adjusting exterior mirrors

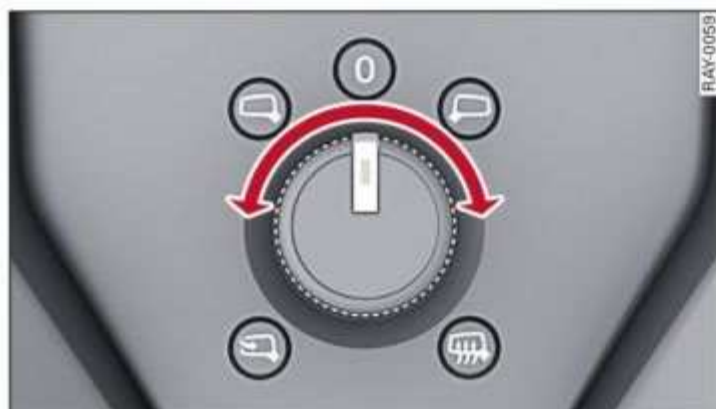

Fig. 44 Driver's door: knob for the exterior mirrors

- ▶ Turn the knob in the driver's door to the desired position:

0 – Deactivates all adjustment functions.

↔ / ↔ – Selects the left or right exterior mirror. To adjust the mirror glass in a mirror, press the knob in the desired direction.

🔥 – Heats* the mirror glass depending on the outside temperature.

🔒 – Folds the exterior mirrors*. To fold the mirrors out, turn the knob to one of the other positions. In the MMI, you can select if the mirrors

fold in automatically when you lock the vehicle
⇒ page 38.

Front passenger's exterior mirror tilt function*

Requirement: the knob must be in the position for the front passenger's exterior mirror.

The mirror surfaces tilt slightly when reverse gear is selected to provide a better view, for example of the edge of the curb.

You can adjust the mirror surface by turning the knob in the desired direction.

The mirror moves from the reversing position back to the original position:

- When you switch the ignition off
- When you drive forward at speeds faster than 9 mph (15 km/h).
- When the knob is no longer in the position for the front passenger exterior mirror

! WARNING

Curved mirror surfaces (for example convex) enlarge the field of vision. However, they make objects in the mirror appear smaller and farther away. When using these mirrors to estimate your distance to vehicles behind you when changing lanes, you could estimate incorrectly, which increases the risk of an accident.

! Note

- Applies to: vehicles with power folding exterior mirrors: If the mirror housing was moved by outside forces (such as an impact when maneuvering), you must use the power folding function to fold the mirror all the way out. The mirrors will make a loud noise when they latch into place. The mirror housing must not be moved back into place by hand because this could impair the function of the mirror mechanism.
- Applies to: vehicles without power folding exterior mirrors: If the mirror housing was moved by outside forces (such as an impact when maneuvering), you must move it back in place by hand.

- If you wash the vehicle in an automatic car wash, you must fold the exterior mirrors in to reduce the risk of damage to the mirrors. Never fold power folding exterior mirrors* by hand. Only fold them in and out using the power controls.

i Tips

If the power adjusting function malfunctions, the glass in both mirrors can be adjusted by pressing on the edge of it by hand.

Dimming the mirrors

- ▶ The interior and exterior mirrors dim automatically when light shines on them, for example from headlights on a vehicle behind you.

! WARNING

- If the glass on an automatic dimming mirror breaks, electrolyte can leak out. This liquid can irritate the skin, eyes and respiratory system. If there is contact with the fluid, flush immediately with plenty of water. Seek medical attention if necessary.
- Repeated or long-term exposure to electrolyte fluid can lead to irritation of the airways, especially in people with asthma or other respiratory conditions. Take deep breaths immediately after leaving the vehicle or, if this is not possible, open all of the doors and windows as wide as possible.
- If electrolyte fluid comes into contact with the eyes, flush them thoroughly with plenty of clean water for at least 15 minutes and then seek medical attention.
- If electrolyte fluid comes into contact with the skin, flush the affected area with clean water for at least 15 minutes, and then clean with soap and water and seek medical attention. Clean affected clothing and shoes thoroughly before wearing again.
- If the fluid was swallowed and the person is conscious, flush the mouth with water for at least 15 minutes. Do not induce vomiting unless this is recommended by medical professionals. Seek medical attention immediately.

! Note

If the glass on an automatic dimming mirror breaks, electrolyte can leak out. This liquid damages plastic surfaces and paint. Clean this liquid as quickly as possible, for example with a wet sponge.

i Tips

- If the light reaching the rearview mirror is obstructed, the automatic dimming mirror will not function correctly,
- The automatic dimming mirrors do not dim when the interior lighting is turned on or the reverse gear is selected.

Sun visors



Fig. 45 Roof headliner: sun visor

Sun visor

The sun visors can be moved out of their brackets and turned toward the doors ①.

They can also be moved back and forth lengthwise in this position.

Vanity mirror

The mirror light switches on when the cover over the vanity mirror ② opens.

Vanity mirror in the rear

Applies to: vehicles with vanity mirrors in the rear



Fig. 46 Rear headliner: vanity mirror

- ▶ Press the button to fold the mirror open. The mirror lighting turns on automatically.
- ▶ To change the mirror's angle, move it forward or back with your hand.

Windshield wipers

Switching the windshield wipers on

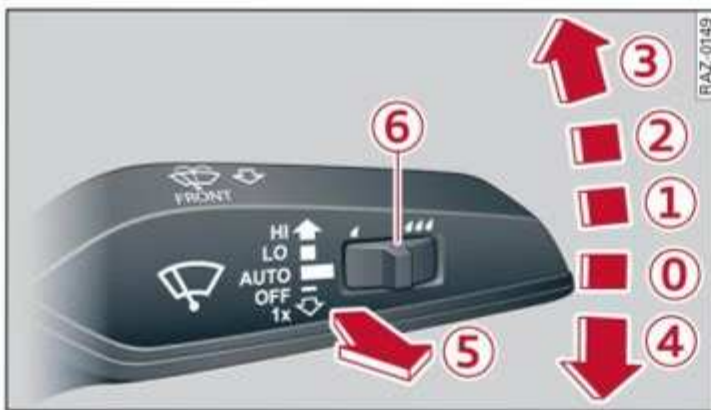

Fig. 47 Lever: windshield wipers

- ▶ Move the lever to the corresponding position:

- ① Windshield wipers off
- ① Rain sensor/intermittent mode. The windshield wipers switch on once the vehicle speed exceeds approximately 2 mph (4 km/h) and it is raining. The higher the sensitivity of the rain sensor that is set (switch ⑥ to the right), the earlier the windshield wipers react to moisture on the windshield. You can deactivate the rain sensor mode, which switches the interval mode on. In intermittent mode, you can adjust the interval time using the switch ⑥.
- ▶ Applies to: MMI: Select on the home screen: **VEHICLE > Light & Visibility > Rain sensor.**

- ② Slow wiping
- ③ Fast wiping
- ④ Single wipe. If you hold the lever in this position longer, the wipers switch from slow wiping to fast wiping.
- ⑤ Clean the windshield . The number of wipes and afterwipes depends on how long the lever is held in position ⑤.

The wipers wipe one time after several seconds of driving to remove water droplets. You can switch this function off by moving the lever to position ⑤ within ten seconds of the afterwipe. The afterwipe function is reactivated the next time you switch the ignition on.

If you hold the lever in position ⑤ for longer than half a second, the edge wiping feature will be activated. This moves the windshield wipers closer to the edge of the windshield and performs an afterwipe to clean the residue that results from the wiping process from the edge of the windshield. The function is available when driving at speeds up to 75 mph (120 km/h).

The headlight washer system* operates only when the low beam headlights are on. If you move the lever to position ⑤, the headlights and the night vision assist camera* are cleaned at intervals.

WARNING

- The rain sensor is only intended to assist the driver. The driver may still need to switch the wipers on manually depending on visibility conditions.
- The windshield must not be treated with water-repelling windshield coating agents. Under unfavorable conditions, such as wetness, darkness, and when the sun is low, these coatings can cause increased glare, which increases the risk of an accident. They can also cause wiper blade chatter.
- Properly functioning windshield wiper blades are required for a clear view and safe driving ⇒ page 64, *Cleaning/changing wiper blades.*

Note

- If there is frost, make sure the windshield wiper blades are not frozen to the windshield. Switching on the windshield wipers when the blades are frozen to the windshield can damage the wiper blades.
- Prior to using a car wash, the windshield wiper system must be switched off (lever in position 0). This prevents the wipers from switching on unintentionally and causing damage to the windshield wiper system.

Tips

- The windshield wipers switch off when the ignition is switched off. You can activate the windshield wipers after the ignition is switched on again by moving the lever to any position. The single wipe function (lever in position 4) also functions when the ignition is switched off.
- Worn or dirty windshield wiper blades result in streaking. This can affect the rain sensor function. Check your windshield wiper blades regularly.
- The washer fluid nozzles for the windshield washer system are heated when the ignition is on if the outside temperature is low.
- When stopping temporarily, such as at a traffic light, the speed of the windshield wipers automatically reduces by one level.

til the windshield wiper moves into the wiper blade replacement position.

- ▶ To bring the windshield wipers into the normal position, switch the ignition on and hold the windshield wiper lever in position 4 until the windshield wipers go back to the original position, or drive faster than 8 mph (12 km/h).

You can also turn the wiper blade replacement position on or off in the MMI:

- ▶ Switch the windshield wipers off (position 0 ⇒ page 63, fig. 47).
- ▶ Applies to MMI: Select on the home screen: **VEHICLE > Settings & Service > Wiper change position.**

Cleaning the wiper blades

Requirement: the windshield wipers must be in the wiper blade replacement position.

- ▶ Fold the windshield wiper arm away from the windshield.
- ▶ For information on cleaning, see ⇒ table on page 294.

Replacing the wiper blades

Requirement: the windshield wipers must be in the wiper blade replacement position.

- ▶ Fold the windshield wiper arm away from the windshield.
- ▶ Hold the wiper blade firmly.
- ▶ Press the locking knob 1 on the wiper blade.
- ▶ Remove the wiper blade from the windshield wiper arm mount 2.
- ▶ Insert the new wiper blade into the mount on the wiper arm until it clicks into place.
- ▶ Place the wiper arm back on the windshield.
- ▶ Exit the wiper blade replacement position.

WARNING

- For safety reasons, the windshield wiper blades should be replaced once or twice each year.
- Dirty windshield wiper blades can impair vision, which increases the risk of an accident.

Cleaning/changing wiper blades

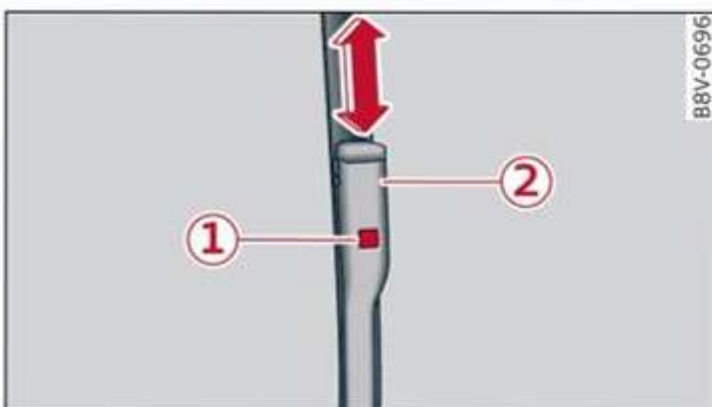

Fig. 48 Windshield wipers: changing the wiper blades

Wiper blade replacement position

- ▶ Switch off the ignition and hold the windshield wiper lever in position 4 ⇒ page 63, fig. 47 un-

Note

- The windshield wipers must only be lifted up when in the wiper blade replacement position. Otherwise, you risk damaging the paint on the hood or the windshield wiper motor.
- You should not move your vehicle or press the windshield wiper lever when the wiper arms are folded up from the windshield. The windshield wipers would move back into their original position and could damage the hood and windshield.

Tips

- You can also use the wiper blade replacement position for other reasons, for example if you want to protect the windshield from icing by using a cover.
- You cannot activate the wiper blade replacement position when the hood is open.

Messages

The following messages may appear depending on the vehicle equipment:

If the  indicator light turns on, then there is a windshield wiper malfunction. The message that is also displayed indicates the cause and possible solutions. If one of the messages does not turn off, drive immediately to an authorized Audi dealer or authorized Audi Service Facility to have the malfunction repaired.

 Automatic wipers: malfunction! See owner's manual

The light/rain sensor is malfunctioning. You can still control all functions that are not controlled by the rain sensor using the windshield wiper lever. Drive immediately to an authorized Audi dealer or authorized Audi Service Facility to have the malfunction repaired.

Digital compass**Switching the compass on and off**

Applies to: vehicles with digital compass



Fig. 49 Rearview mirror: digital compass is switched on

- To turn the compass on or off, press the button  until the compass display in the mirror turns on or off.

The digital compass only works when the ignition is turned on. The directions are indicated with abbreviations: **N** (north), **NE** (northeast), **E** (east), **SE** (southeast), **S** (south), **SW** (southwest), **W** (west), **NW** (northwest).

Tips

To prevent inaccurate compass readings, do not bring any remote controls, electrical devices or metallic objects near the mirror.

Adjusting the magnetic zone

Applies to: vehicles with digital compass

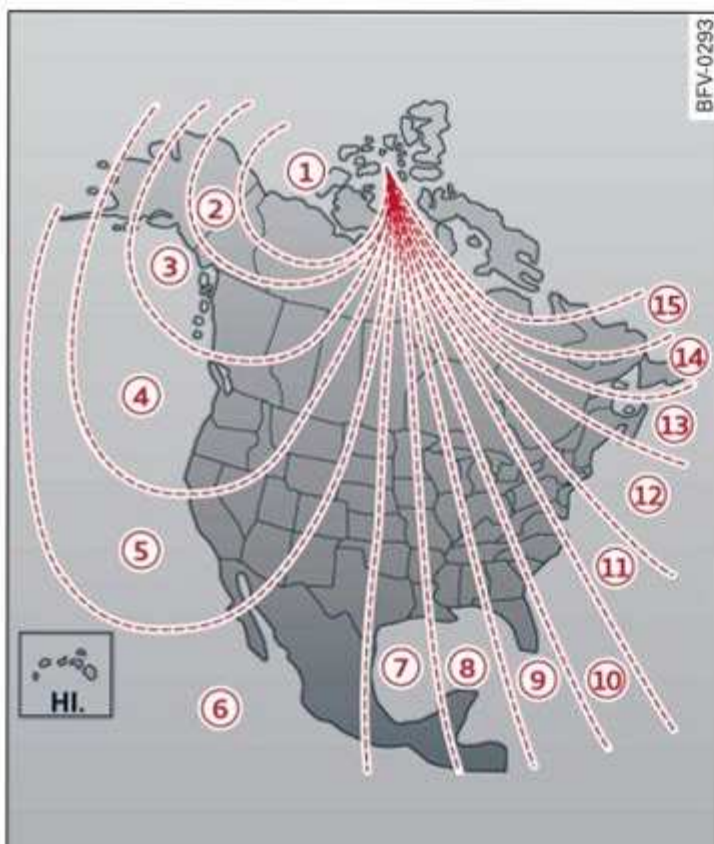

Fig. 50 Magnetic zone map

The magnetic zone must be adjusted correctly for the compass to read accurately.

- ▶ Press and hold the button ① ⇒ page 65, fig. 49 until the number of the magnetic zone appears in the interior rearview mirror.
- ▶ Press the button ① repeatedly to select the correct magnetic zone. The selection mode turns off after a few seconds.

Calibrating the compass

Applies to: vehicles with digital compass

You must recalibrate the compass if it does not display the correct direction.

- ▶ Press and hold the button ① until a C ⇒ page 65, fig. 49 appears in the rearview mirror.
- ▶ Drive in a circle at about 6 mph (10 km/h) until a direction is displayed in the rearview mirror.

WARNING

To reduce the risk to yourself and other road users, calibrate the compass in an area where there is no traffic.

Sitting correctly and safely

Maintaining the correct seating position

General information

As the driver, you are responsible for making sure each person in the vehicle is sitting correctly in their seat and maintaining this correct seating position while driving. Make sure that:

- Each person in the vehicle has adjusted their seat correctly ⇒ *page 67*
- The steering wheel is adjusted correctly ⇒ *page 74*
- The mirrors are adjusted so that there is a sufficient view of the area around the vehicle ⇒ *page 61*
- Each person in the vehicle has adjusted their head restraint correctly ⇒ *page 75*
- Each person in the vehicle has adjusted their safety belt correctly ⇒ *page 77*
- The activation status of the front passenger's airbag is suitable for the person in the front passenger's seat ⇒ *page 83*
- Children are secured in suitable child safety seats that are secured to appropriate vehicle seats ⇒ *page 85*. Read and observe the important safety information pertaining to the use of child safety seats on the front passenger's seat ⇒  in *General information on page 85*.

Examples of incorrect seating positions

Safety belts can only provide its optimal protection when they are routed correctly. Incorrect seating positions significantly reduce the protective functions of the safety belts and increase the risk of injury due to incorrect belt routing.

The following list includes examples of seating positions that could be dangerous for all vehicle occupants. This is not a complete list. Audi would simply like to increase your awareness of the topic. The following points apply when the vehicle is in motion:

- Never stand inside the vehicle.
- Never stand on the seats.

- Never kneel on the seats.
- Never tilt your backrest too far back.
- Never lean against the instrument panel.
- Never lie down on the rear bench seat.
- Never sit only on the front section of the seat.
- Never sit sideways on the seat.
- Never lean against the window.
- Never place your feet out of the window.
- Never place your feet on the instrument panel.
- Never place your feet on the seat cushion.
- Never ride in the footwell.
- Never sit on the armrests.
- Never drive or ride in a seat without fastening your safety belt.
- Never ride in the luggage compartment.

WARNING

Incorrect seating positions, failure to wear a safety belt, or being too close to an airbag increase the risk of serious or fatal injury to vehicle occupants, especially if the airbags deploy and come into contact with occupants who are not seated correctly. Note the important information and warnings in the chapters for the topics given above.

Tips

- Save your seat profile* ⇒ *page 80*. This allows you to access your personal seat profile quickly and easily at any time.
- If you or other passengers in the vehicle have physical limitations that prevent sitting in a correct position, modifications to the vehicle may be necessary. For more information, contact an authorized Audi dealer or authorized Audi Service Facility, or call Audi customer support at 1-800-822-2834.

Front seats

General information

Make sure that:

- You can press the pedals down completely while your legs are slightly bent. ►

- The distance between your upper body and the steering wheel or instrument panel is at least 10 inches (25 cm).
- The distance between your knees and the instrument panel is at least 4 inches (10 cm).
- Your thighs are lightly supported by the front surface of the seat.
- The backrest is in an upright position and the back of the person seated is resting against it.
- You have a sufficient view of the area around the vehicle.
- You have a clear view of the instrument cluster, indicator lights, and the head-up display*.

Seat settings menu: quick access

If you press on the image of the driver's or front passenger's seat in the climate control system menu ⇒ *page 97, fig. 84* ①, you will go directly to the seat settings for that seat.

WARNING

- If you are too close to the steering wheel or instrument panel, the airbag system cannot provide the optimal protection, which increases the risk of injury and death.
- To reduce the risk of injury to the driver in the event of sudden braking maneuvers or accidents, never drive with the backrest reclined very far. The airbag system and safety belts can only provide optimal protection when the backrest is in an upright position and the driver is wearing the safety belt correctly. If the backrest is angled back too far, the safety belt can shift to soft areas of the body, such as the stomach, which increases the risk of injury.
- To reduce the risk of an accident, only adjust the seats when the vehicle is stationary.
- Be careful when adjusting the seat. Lack of control or attention when adjusting can result in injuries due to pinching for vehicle occupants both in the front seats and rear seats.
- Never place objects in the driver's footwell. Objects could shift and enter the area around the pedals, which could prevent you from using them. You would then be unable to use the pedals if sudden driving or brak-

- ing maneuvers were needed, which increases the risk of an accident.
- Make sure that the floor mats are always securely attached.
- To reduce the risk of an accident, never place additional floor mats or other floor covers over the installed floor mats, because this reduces the pedal's range of motion and can impair pedal operation.
- To reduce the risk of injury, never place your feet on the instrument panel, out of the window, or on the seat surfaces. This also applies to persons in the rear seats.

Note

Applies to: vehicles with manually adjustable head restraints

To reduce the risk of damage, be very careful when adjusting the seat to make sure the head restraints do not come into contact with the headliner or the sunroof*.

Tips

At the same time, only move the respective seat using the controls.

Adjusting the front seats with buttons



Fig. 51 Front seat: seat adjustment buttons

You can adjust the basic settings using the buttons.

The settings depend on the vehicle equipment.

Adjusting the seat position

- ▶ To move the seat forward or backward, push the button ① forward or backward. ▶

- ▶ To adjust the seat upward or downward, push the rear section of the button ① upward or downward.
- ▶ To adjust the seat surface, press the front part of the button ① upward or downward.

Adjusting the backrests

- ▶ To move the backrest forward or backward, press the button ② forward or backward.

Adjusting the head restraints

- ▶ See ⇒ page 75

Adjusting the lumbar support

- ▶ To adjust the lumbar support, press the button ③ in the desired direction.

Massage function

Switching the massage function on or off ④. Setting the massage type and intensity ⇒ page 69.

WARNING

The power front seats can also be adjusted when the ignition is switched off. To reduce the risk of injury, children should never be left unattended in the vehicle.

Adjusting the front seats in the MMI



Fig. 52 Seat setting

You can adjust additional settings in the MMI.

The settings and the number of menus and buttons depend on the vehicle equipment.

Operating

Applies to: MMI

- ▶ Select on the home screen: **VEHICLE > Seats**.
- ▶ To access the various menus ③, swipe to the left or right.
- ▶ To display the various seats, press > or < ④.

The red coloring in the symbol ⑤ indicates which seat is selected.

Seat setting

Applies to: MMI

- ▶ To select a seat setting, press ① if necessary.
- ▶ Press the respective arrow ② until the desired position is reached.

Massage

See ⇒ page 69

Seat temperature balance

Using the seat temperature balance, you can heat the backrest and seat surface to different temperatures ⇒  in *Settings* on page 100.

- ▶ To adjust the seat temperature balance, slide the control upward or downward.

Additional seat settings

See ⇒ page 70

Tips

Applies to: reclining rear seats: Only the upper thigh support can be adjusted on the front passenger's seat.

Front seat massage function

Applies to: vehicles with massage function

Selecting the massage function

Applies to: MMI

- ▶ To open the **Massage** menu, press the  button ④ ⇒ page 68, fig. 51.

Switching the massage function on or off

Applies to: MMI

- ▶ To switch the massage function on or off, press the  button ④ ⇒ page 68, fig. 51. Or:
- ▶ Press **Start/Stop** on the MMI.

Setting the massage type and intensity

Applies to: MMI

- ▶ To adjust the massage type, press the desired button on the MMI, for example **Wave**.
- ▶ To adjust the intensity of the massage, press **Intensity** on the MMI repeatedly until the desired level is reached. ▶

i Tips

The massage function switches off automatically after approximately 10 minutes.

Additional settings in the MMI

You can adjust additional settings and switch functions on or off in the MMI.

- ▶ Applies to MMI: Select on the home screen: **VEHICLE > Seats > Additional seat settings**.

Depending on the vehicle equipment, the following options may be available.

Reset seat position

You can adjust the position of the front passenger's seat to match the driver's seat. The rear seats are set to a pre-defined position.

Driver seat entry assistance/Front passenger seat entry assistance

Entry assistance makes it easier to enter or exit the vehicle.

Rear seat entry assistance

If the function is switched on, the rear seat will automatically move all the way back when the door next to that seat is opened.

Passenger side rear seat adjustment

If the function is switched on, the front passenger's seat can be adjusted from the rear seat ⇒ page 72.

Rear seat upright/reclining position

You can set the upright/reclining position on the MMI ⇒ **△** in *Adjusting the comfort position on page 74*.

Adjusting the front passenger's seat from the driver's seat

Applies to: vehicles with front passenger seat adjustment

You can adjust the front passenger's side with the driver's seat buttons.

Applies to: MMI:

- ▶ Select on the home screen: **VEHICLE > Seats**.

- ▶ To display the various seats, press **>** or **<**.
- ▶ To switch on the function, press the **⏮** button. The lower edge of the button will turn red.

After you have switched on the function, you can adjust the front passenger's seat using the driver's seat buttons ⇒ page 68, fig. 51.

i Tips

The function switches off automatically when you exit the menu.

Front center armrest

Applies to: vehicles with a front center armrest



Fig. 53 Cockpit: center armrest



Fig. 54 Cockpit: divided center armrest

Adjusting the center armrest

Applies to: vehicles with undivided armrest

- ▶ Press the button **1** to raise or lower the armrest.

Applies to: vehicles with divided armrest

- ▶ Move the armrest upward or downward to raise and lower the armrest.
- ▶ To slide the armrest forward or back, press the button **1**.

⚠ WARNING

- In certain positions, the front center armrest can interfere with arm movement, which increases the risk of injury.
- Applies to: vehicles with undivided armrest: Loose objects can be thrown around the vehicle interior during sudden driving or braking maneuvers, which increases the risk of an accident. Store objects securely while driving.
- Applies to: vehicles with front center armrest The center armrest must remain closed while driving. Otherwise, the protective function of the center airbag will be significantly impaired and the risk of injury will increase, because the front center airbag deploys from the driver's seat backrest.

Rear seats**General information****⚠ WARNING**

- The power seats can also be adjusted when the ignition is switched off. To reduce the risk of injury, children should never be left unattended in the vehicle for this reason.
- Be careful when adjusting the seat. Unsupervised or careless seat adjustment could cause parts of the body to be pinched, which increases the risk of injury.

! Note

Before adjusting the seat position, you must remove the retainers for the LATCH child safety seat restraint system, if installed.

i Tips

Only control a seat using one control panel at a time.

Adjusting seats with buttons

Applies to: vehicles with power adjustable rear seats

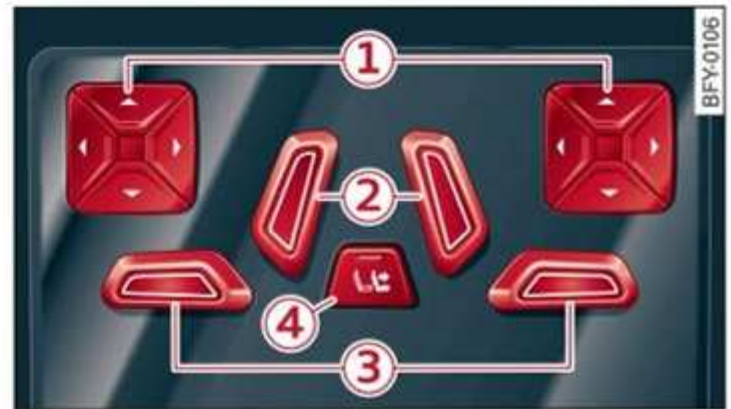

Fig. 55 Rear center armrest/full-length center console: seat adjustment buttons

You can adjust the basic settings using the buttons.

The settings depend on the vehicle equipment.

Adjusting the lumbar support

- ▶ To adjust the curvature of the lumbar support, press the left or right button ①.
- ▶ To adjust the height of the lumbar support, press the upper or lower button ①.

Adjusting the backrests

- ▶ To move the backrest forward or backward, press the button ② to the left or right.

Adjusting the head restraints

- ▶ See ⇒ page 76

Adjusting the seat position

- ▶ To adjust the seat forward or backward, press the button ③ to the left or right. The backrest will automatically adjust with it.
- ▶ To move the seat upward or downward, press the button ③ upward or downward.

Adjusting the front passenger's seat

See ⇒ page 72

Adjusting the comfort position

See ⇒ page 73

Adjusting seats with the Rear Seat Remote

Applies to: vehicles with Rear Seat Remote



Fig. 56 Rear Seat Remote: selecting the seat to be adjusted

You can adjust the rear seat using the Rear Seat Remote.

Pay attention to the safety precautions for vehicles with reclining seat systems ⇒  in *Adjusting the comfort position on page 74*.

For general use of the Rear Seat Remote, read the information in ⇒ *page 28*.

Operating



Applies to: Rear Seat Remote

- ▶ Press **SEATS** on the home screen.
- ▶ To display the various seats, press the button .



The red coloring in the symbol  indicates which seat is selected.

Depending on the vehicle equipment, the functions listed below may be available.

Seat setting

- ▶ Select on the home screen: **SEATS** > **Seat setting**.
- ▶ If necessary, press  or .
- ▶ If necessary, press the desired seat on the Rear Seat Remote.
- ▶ To select a seat setting, press a button if necessary, for example .
- ▶ Press the respective arrow until the desired position is reached.



Massage

- ▶ Select on the home screen: **SEATS** > **Massage**.
- ▶ If necessary, press  or .
- ▶ If necessary, press the desired seat on the Rear Seat Remote.

- ▶ To switch the massage function on or off, press the **Start/Stop** button.
- ▶ To adjust the massage type, press the desired button, for example **Wave**.
- ▶ To adjust the intensity of the massage, press the **Intensity** button repeatedly until the desired level is reached.
- ▶ Applies to: foot massage on the front passenger's seat: Requirement: the leg support must be folded out. To adjust the foot size, press the  button and select **S**, **M**, or **L**. You can adjust the foot heating in the climate control menu ⇒ *page 99*.

Seat temperature balance

Using the seat temperature balance, you can heat the backrest and seat surface to different temperatures ⇒  in *Settings on page 100*.

- ▶ Select on the home screen: **SEATS** > **Seat temperature balance**.
- ▶ If necessary, press  or .
- ▶ If necessary, press the desired seat on the Rear Seat Remote.
- ▶ To adjust the seat temperature balance, slide the control upward or downward.

Note

- Do not wear shoes when using the foot massage and the leg support.
- Do not place any objects on the leg support.
- Do not exceed the maximum load of 110 lb.

Tips

The massage function switches off automatically after approximately 10 minutes.



Adjusting the front passenger's seat from the rear

Applies to: vehicles with power adjustable rear seats

Depending on the equipment, you may be able to adjust the front passenger's seat using the buttons in the center armrest/center console or on the Rear Seat Remote.

The settings depend on the vehicle equipment. ▶



Requirements

- ▶ Read and follow the important safety precautions about the reclining rear seats ⇒  in *Adjusting the comfort position on page 74*.
- ▶ Make sure **Passenger side rear seat adjustment** is switched on in the MMI ⇒ *page 70*.
- ▶ To activate the front passenger's seat adjustment, press the button  ⇒ *page 71, fig. 55*. The LED in the button will turn on.
- ▶ Applies to: Rear Seat Remote: Press **SEATS** on the Rear Seat Remote. Press the desired function and select the front passenger seat ⇒ *page 72, fig. 56*.



Adjusting the backrests

- ▶ Applies to: buttons in the center console/center armrest: Press the button  to the left or right ⇒ *page 71, fig. 55*.
- ▶ Applies to: Rear Seat Remote: Press the  button. Press the respective arrow until the desired position is reached.

Adjusting the front passenger seat forward or backward

- ▶ Applies to: buttons in the center armrest/center console: Push the button  ⇒ *page 71, fig. 55* to the left or right.
- ▶ Applies to: Rear Seat Remote: Press the  button. Press the respective arrow until the desired position is reached.

Adjusting the front passenger seat upward and downward

- ▶ Applies to: buttons in the center armrest/center console: Press the button  ⇒ *page 71, fig. 55* upward or downward.
- ▶ Applies to: Rear Seat Remote: Press the  button. Press the respective arrow until the desired position is reached.

Adjusting the leg support

Applies to: reclining rear seats

Requirement: the reclining position must be selected.

- ▶ Applies to: Rear Seat Remote: Press the  button to fold the leg support out and in. Press the respective arrow until the desired position is reached.

- ▶ To adjust the height or depth of the leg support, adjust the front passenger seat forward/backward or upward/downward.
- ▶ To adjust the foot massage area, adjust the angle of the front passenger seat backrest.

WARNING

Applies to: reclining seats: To reduce the risk of injury, make sure the area between the leg support and the front passenger's seat backrest is clear before folding in the leg support.

Tips





- If the settings *cannot* be applied from the rear, then the child safety lock may be switched on or the front passenger's seat adjustment for the rear seats may be switched off in the MMI ⇒ *page 70*. If the child safety lock is switched on, the  button in the driver's door ⇒ *page 49* turns on.

Adjusting the comfort position



Applies to: vehicles with reclining/upright position or reclining seat system





Depending on the equipment, you may be able to adjust the comfort position using the buttons in the rear door or on the Rear Seat Remote.

Selecting the reclining position

- ▶ Applies to: buttons in the rear door for the reclining/upright position: To adjust the reclining position, press the  button until the seat has reached its end position.
- ▶ Applies to: Rear Seat Remote: Select on the home screen: **SEATS > Seat setting**.
- ▶ Press  or  until the  or  symbol is displayed.
- ▶ Press  or .

Selecting the upright position

- ▶ Applies to: buttons in the rear door for the reclining/upright position: To set the upright position, press the  or  button until the seat has reached its end position.
- ▶ Applies to: Rear Seat Remote: Select on the home screen: **SEATS > Seat setting**.

- ▶ Press \rangle or \langle until the  or  symbol is displayed.
- ▶ Press  or .

Reclining rear seat

Applies to: reclining rear seats

In the reclining position, the front passenger seat is moved forward, the head restraint on the front passenger seat is folded forward, and the backrest is tilted forward. Depending on the last setting in the Rear Seat Remote, the leg support may fold out and the screen on the front passenger's seat may tilt forward.

In the reclining position, you can adjust the foot massage, for example \Rightarrow page 72.

In the upright position, the leg support is folded in, the front passenger seat is moved back into the original position, and the head restraint is moved to the upright position \Rightarrow .

WARNING

Applies to: reclining rear seats:

- Due to the risk of fatal injury, the front passenger's seat must not be used as a seat when it is in the reclining position.
- Due to the risk of injury, never select the reclining position when the front passenger's seat is occupied.

Tips

- If the settings *cannot* be applied from the rear, the child safety lock might be switched on. If the child safety lock is switched on, the  button in the driver's door \Rightarrow page 49 turns on.

Footrests in rear

Applies to: vehicles with footrests in rear

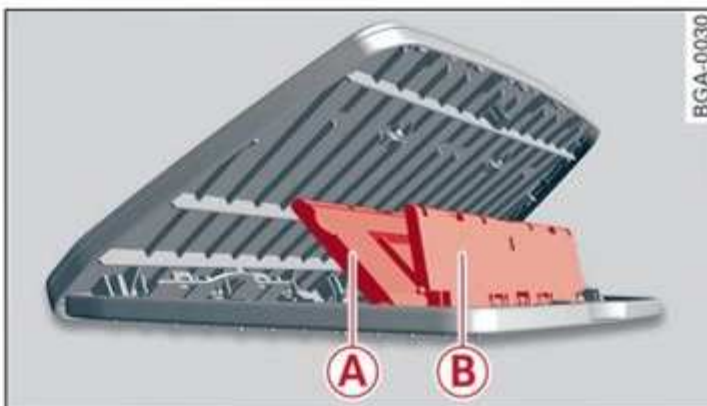



Fig. 57 Rear footwell: folding the footrest out



Fig. 58 Rear footwell: footrest

The angle of the footrest can be adjusted to two positions \Rightarrow fig. 57:

-  Higher angle
-  Lower angle

Note

To reduce the risk of damaging the footrests, you must make sure the footrests under the seat will not be crushed when adjusting the driver's or front passenger's seat.

Steering wheel

General information

Make sure that:

- The distance between your upper body and the steering wheel is at least 10 inches (25 cm).
- Your arms are bent slightly at the elbows.
- You have a sufficient view of the area around the vehicle and you have a clear view of the instrument cluster and head-up display*.

- You are always holding the steering wheel with both hands on the outer edge at the sides (9:00 and 3:00 position) when driving.

WARNING

- To reduce the risk of an accident, make sure the steering wheel is adjusted correctly and cannot be moved out of position before you start to drive.
- If you are too close to the steering wheel, the driver's airbag cannot provide optimal protection, which increases the risk of injury or fatality.
- Never hold the steering wheel in the 12:00 position or in any other way, such as holding the center of the steering wheel. Otherwise, your arms, hands, and head could be injured in the event that the driver's airbag deploys.

Adjusting the steering wheel position



Fig. 59 Steering column: switch for adjusting the steering wheel position

The steering wheel position can be adjusted electrically up/down and forward/back.

- ▶ To adjust the steering wheel, press the button in the direction in which you would like the steering wheel to move.

The steering wheel can also be adjusted when the ignition is switched off.

Head restraints

General information

Applies to: vehicles with adjustable head restraints



Fig. 60 Correctly-adjusted head restraint

Make sure that:

- The upper edge of the head restraint is as even as possible with the top of your head.
- The head restraint is as close as possible to the back of the head.
- The head restraints on the occupied rear seats are positioned all the way up or folded upward.

WARNING

- There is one head restraint for each seat. All vehicle occupants must adjust the head restraints correctly before every trip. Having head restraints that are not adjusted correctly or not installed in the vehicle increases the risk of a neck injury during sudden or unexpected driving or braking maneuvers or in a collision.
- Only remove the rear seat head restraints if it is necessary to install a child safety seat → page 85. Stow the removed head restraints securely, for example in the luggage compartment. Reinstall the head restraints immediately once the child safety seat has been removed. Driving without head restraints increases the risk of serious neck injuries.
- Depending on the equipment, the front head restraints may be active head restraints. If triggered, a part of the head restraint will move several inches forward to provide additional support to the head. If triggered, have the head restraints serviced

immediately by an authorized Audi dealer or authorized Audi Service Facility.

Front head restraints

Applies to: vehicles with adjustable head restraints

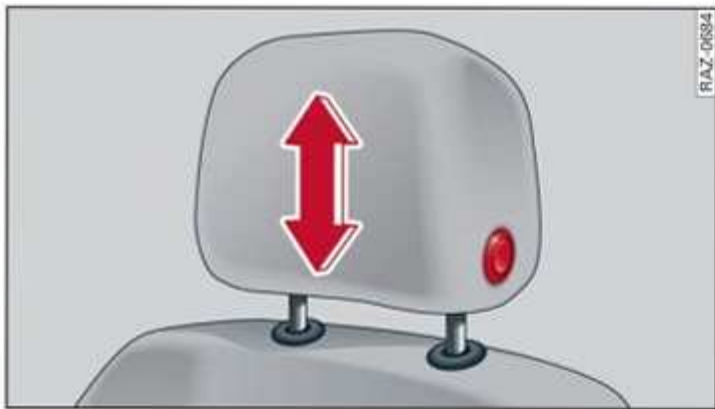

Fig. 61 Front seat: adjusting the head restraint

The settings depend on the vehicle equipment.

Manual head restraint adjustment

Applies to: vehicles with manually adjustable head restraints

- ▶ To adjust the head restraint upward, slide it until it locks into place.
- ▶ To adjust the head restraint downward, press the button on the slide and slide the head restraint. Release the button and slide the head restraint farther until it locks into place.
- ▶ Applies to: vehicles with reclining seats: To move the head restraint on the front passenger's seat upward or downward, slide the head restraint upward or downward until it locks into place.

Power head restraint adjustment

Applies to: vehicles with power adjustable head restraints

- ▶ To adjust the head restraint upward or downward, push the button ② ⇨ *page 68, fig. 51* upward or downward.

i Tips

Applies to: vehicles with power adjustable head restraints: To prevent the head restraints from running into the headliner, the power head restraints* automatically move forward or upward when the seat is adjusted.

Rear head restraints

Applies to: vehicles with adjustable head restraints

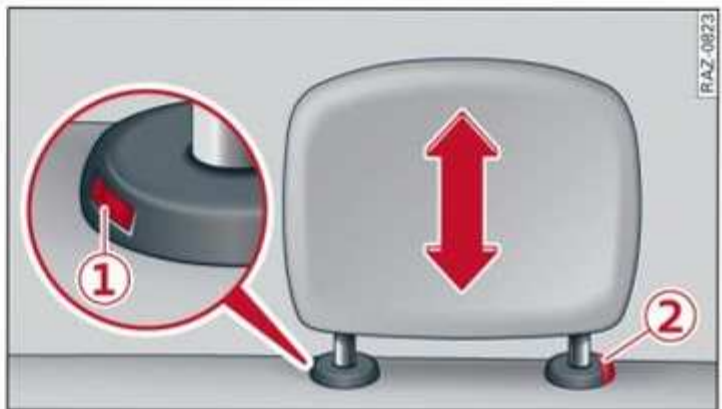

Fig. 62 Rear seat: adjusting or removing the head restraint



Fig. 63 Center rear seat*: folding up the head restraint

Adjusting the outer head restraints

Applies to: vehicles with manually adjustable head restraints

- ▶ To adjust the head restraint upward, slide it until it locks into place.
- ▶ To adjust the head restraint downward, press the button ② and slide the head restraint. Release the button and slide the head restraint farther until it locks into place.

Applies to: vehicles with power adjustable head restraints

- ▶ To adjust the head restraint upward or downward, push the button ② ⇨ *page 71, fig. 55* forward or backward. Or:
- ▶ Applies to: Rear Seat Remote: To adjust the head restraint upward or downward: select on the home screen: **Seats > Setting** and press on the picture of the head restraint for the respective seat. Press the up or down arrows until the desired position is reached.

Adjusting the center head restraint

- ▶ Fold the head restraint upward until it clicks into place ⇨ *fig. 63*.

- ▶ To fold the head restraint downward, press the button on the back of the head restraint.

Removing the head restraints

Applies to: vehicles with removable head restraints

- ▶ Move the head restraint upward all the way.
- ▶ Insert a suitable object, such as the extended vehicle key or mechanical key, into the release point ① on the inside or outside of the base.
- ▶ Press the button ② and pull the head restraint out of the backrest ⇒  in *General information on page 75*.

Installing the head restraints

Applies to: vehicles with removable head restraints

- ▶ Slide the posts on the head restraint down into the guides until the posts click into place.
- ▶ Press the button ② and slide the head restraint all the way down. It should not be possible to remove the head restraint from the backrest without pressing the button.

Safety belts

General information

Each seat is equipped with a three-point safety belt. Safety belts that are worn correctly are the most effective way to reduce the risk of serious or fatal injuries in a collision. Therefore, wear your safety belt correctly and make sure that all persons in the vehicle are also wearing their safety belts correctly when the vehicle is moving.

Even though your vehicle is equipped with an airbag system, each person in the vehicle must still always wear the appropriate safety belt. In addition to their normal protective function, safety belts also hold vehicle occupants in the correct seating position in the event of a collision so that the airbags can deploy correctly and provide additional protection. Safety belts provide protection during collisions when the airbags do not deploy or if they have already deployed.



WARNING

The risk of serious or fatal injury increases if the safety belt is not fastened, if it is worn incorrectly, or if it is damaged.

- All vehicle occupants, including the driver, must fasten their safety belts correctly before every trip and must always keep their safety belts fastened during the trip, regardless of whether the seat is equipped with an airbag or not. This also applies to children that are seated in a child safety seat that is appropriate for their weight and age and that is secured with a safety belt.
- In the event of a collision, vehicle occupants who are not wearing safety belts could be propelled through the vehicle interior and collide with vehicle components, such as the steering wheel, instrument panel, windshield, or doors. In some situations, vehicle occupants could also be ejected from the vehicle. Vehicle occupants in the rear seats who do not wear safety belts not only endanger themselves, but also other persons in the vehicle.
- Only one person may be fastened with a safety belt at a time. Never secure more than one person, including children, with a single safety belt.
- Never allow children or infants to ride on another person's lap and be belted into the safety belt with them.
- Insert the belt buckle only in the belt latch belonging to the corresponding seat, so that the protective function is not impaired.
- To ensure the maximum protective function of the safety belts, all persons in the vehicle must sit in the correct seating position ⇒ *page 67*.
- Check the condition of your vehicle's safety belts regularly ⇒ *page 294*. If you find damage to the belt webbing, the belt connections, the retractor, or the buckle, have the damaged safety belt replaced by an authorized Audi dealer or authorized Audi Service Facility.
- The safety belts must not be removed or modified in any way. Do not attempt to repair the safety belts yourself.
- Safety belts that are strained during an accident must be replaced by an authorized Audi dealer or authorized Audi Service Facility.

Correct safety belt positioning

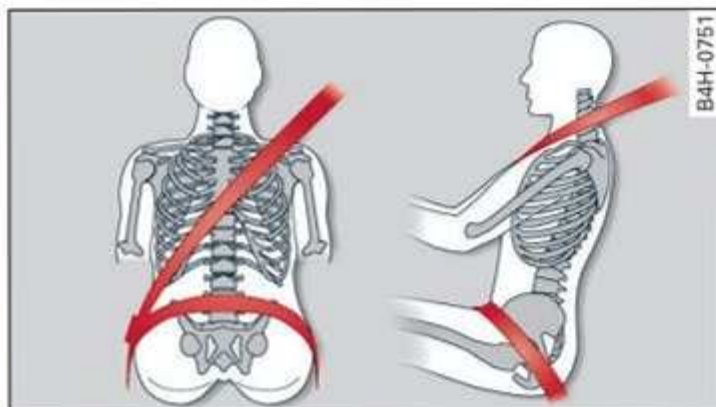

Fig. 64 Lap/shoulder belt positioning



Fig. 65 Safety belt positioning for pregnant women

Fastened safety belts only offer optimal protection during an accident and reduce the risk of serious injury or death when they are positioned correctly. Furthermore, the correct safety belt position holds the vehicle occupant in place so that a deployed airbag can provide maximum protection. Therefore, always fasten the safety belt and make sure it is positioned correctly ⇒ *fig. 64*.

To ensure the safety belt is positioned correctly, make sure of the following points:

- The lap portion of the safety belt must be located across the lap.
- The shoulder portion of the safety belt must rest over the center of the shoulder.
- The safety belt must always rest flat and securely on the body.

For pregnant women, the safety belt must rest evenly across the chest and as low and flat as possible on the lap, so that no pressure is applied to the lower abdomen. This should be done throughout the entire pregnancy ⇒ *fig. 65*.

WARNING

Incorrect safety belt positioning can cause serious injury in the event of an accident or during sudden braking or driving maneuvers.

- Never drive with the backrest reclined extremely far. The more the backrest is tilted back, the greater the risk of injury due to the safety belt being routed incorrectly.
- The safety belt itself or a loose safety belt can cause serious injuries if it shifts onto soft areas of the body, such as the stomach.
- The shoulder portion of the safety belt must lie over the center of the shoulder and chest, and never under the arm, behind the back, or across the neck or face.
- The lap portion of the safety belt must lie across the lap and never over the stomach.
- The safety belt must lie flat and securely on the upper part of the body and the lap.
- The belt webbing must not be pinched or twisted, or rub against sharp edges.
- If the safety belt height is set incorrectly and/or the safety belt is routed incorrectly, then the safety belt's protective function will be impaired in the event of an accident. Make sure the safety belt is at the right height and is routed correctly for the person in the vehicle who is using it.
- A safety belt that is too loose may lead to injuries during an accident, because your body will move farther forward due to kinetic energy and will be stopped abruptly by the belt.
- Heavily bulky, loose clothing (for example, a coat over a sports jacket) may prevent the seat and safety belts from functioning correctly.
- Do not position the safety belt over hard or breakable objects (such as glasses, pens, etc.).
- The lap belt portion of the safety belt must sit as low as possible on the lap of pregnant women and lie flat under the belly.

Note

Make sure that there are no hook-and-loop fasteners or sharp objects such as zippers or

rivets on clothing in the area where the safety belt is worn. Otherwise, the safety belt could be damaged.

Fastening and unfastening safety belts

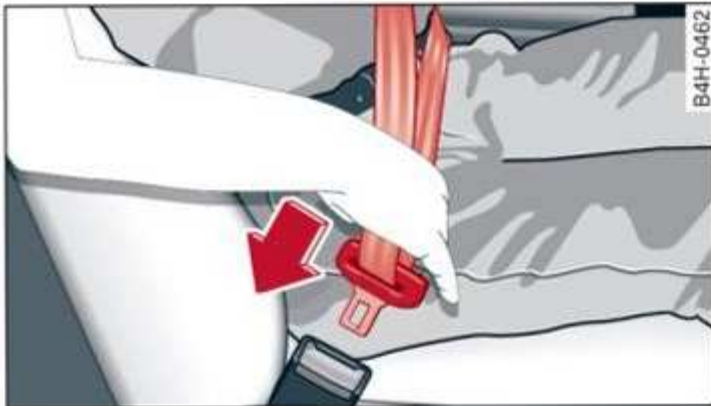

Fig. 66 Belt buckle and belt latch



Fig. 67 Releasing the belt buckle from the belt latch

Observe the safety precautions ⇒ page 77.

Fastening the safety belt

- ▶ Pull the safety belt by the belt buckle evenly across your chest and lap.
- ▶ Insert the belt buckle in the belt latch belonging to the seat until it audibly engages ⇒ fig. 66.
- ▶ Pull on the belt to make sure that the belt is securely locked in the latch.

Unfastening the safety belt

- ▶ Press the red button on the belt latch ⇒ fig. 67. The belt buckle will pop out.
- ▶ Guide the belt back by hand so that the safety belt can roll up more easily.

Safety belt monitoring system

 - If the indicator light turns on or flashes, a front safety belt is not fastened or it has been un-

fastened while driving. There may be additional audible warning signals.

Depending on the equipment, the safety belts in the rear may also be monitored using the following indicator lights:

 - If this indicator light turns on, the safety belt for the corresponding rear seat is not fastened.

 - If this indicator light turns on, the safety belt for the rear seat has been fastened.

Adjusting the height of the safety belt

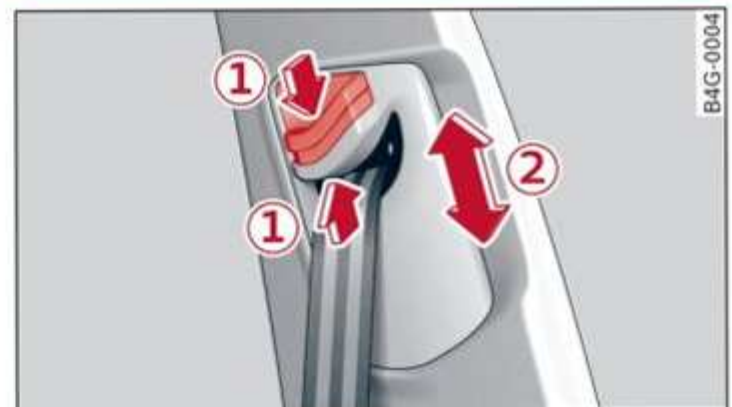

Fig. 68 Belt height adjustment for the front seats - safety belt relay

- ▶ To move the belt higher, slide the safety belt relay ② upward.
- ▶ To move the belt lower, press the release button ① and slide the safety belt relay ② downward.
- ▶ To check if the safety belt relay is securely locked in place, pull firmly on the belt.

Tips

You can also adjust the height of the front seats to change the position of the safety belts.

Additional safety belt functions

Belt retractor lock

The safety belts on the rear seats and on the front passenger seat are equipped with a belt retractor lock.

- ▶ If you secure a child safety seat with a safety belt, the belt retractor lock on the safety belt ▶

may need to be activated. Follow the instructions from the child safety seat manufacturer.

- ▶ When a person in the vehicle has fastened a safety belt, the belt retractor lock should not be activated. If the belt retractor lock has been activated unexpectedly, deactivate it.

Deactivating or activating the belt retractor lock
⇒ page 88.

Safety belt retractor

The safety belts are equipped with an automatic belt retractor. This automatic retractor allows the safety belt to be pulled all the way out when the belt is pulled slowly. However, the automatic retractor locks during sudden braking maneuvers. It also locks the belts when accelerating, driving uphill, and driving around curves.

Belt force limiter

Safety belts with belt force limiters reduce the force placed on the body by the safety belts during a collision.

Belt retractor

After unfastening the safety belt, the electric motor in the reversible belt tensioner will roll the belt up.

Safety belt pretensioners

Safety belts may be tightened with reversible belt tensioners when you start driving and in certain driving situations. If the safety belt is too loose, it will be tightened so that the belt will rest closer to the body.

In some collisions, pyrotechnic belt tensioners may secure the safety belts so that they cannot loosen. This reduces forward movement of the persons in the vehicle.

Tips

Smoke may be released when pyrotechnic belt tensioners deploy. This is not a sign of a vehicle fire.

Memory function

General information

Applies to: vehicles with memory function

With the memory function, you can save and call up seat profiles using the memory buttons in the door trim panel.

Depending on vehicle equipment, some settings such as the driver's seat and exterior mirror position can be stored.

Storing and recalling a seat profile

Applies to: vehicles with memory function

The memory function buttons are located in the door trim panel.

Storing a seat profile

- ▶ Press the **SET** button. If the LED in the button turns on, a seat profile can be stored.
- ▶ Push one of the numbered memory buttons. A tone confirms that the settings were stored.

Accessing a seat profile

- ▶ When the a door is open and the ignition is switched off, press the memory button once briefly. The seat will be fully adjusted to the settings in the seat profile.
- ▶ If the door is closed or the ignition is switched on, press and hold the memory button until the seat is fully adjusted to the settings in the seat profile.

WARNING

- To reduce the risk of an accident, the seat setting can only be recalled when the vehicle is stationary.
- In an emergency, the recall process can be canceled by pressing the seat adjustment button on that seat.

WARNING

The pyrotechnic system can only provide protection during one collision. If the pyrotechnic belt tensioners deploy, the pretensioning system must be replaced by an authorized Audi dealer or authorized Audi Service Facility.

Airbag system

General information

WARNING

- If you have not fastened your safety belt, you are in an incorrect seating position, or you are too close to the airbag system, the airbag system will not be able to protect you. This increases the risk of serious or fatal injuries. Make sure that each person in the vehicle has their safety belt fastened correctly and is sitting in a correct seating position ⇒ *page 67*. This is necessary regardless of whether the seat is equipped with an airbag or not.
- Never place your feet on the instrument panel, out of the window, or on the seat surfaces. To help ensure that the airbag system can deploy correctly, never bend forward or lean on the door or the side window. Otherwise, serious and possibly fatal injuries can occur if the airbags deploy.
- People, animals, or objects between the vehicle occupants and the airbag system can interfere with the correct deployment of the airbag or can be propelled through the vehicle interior, increasing the risk of serious or fatal injuries. Make sure that nothing is located between the vehicle occupants and the airbag system. Do not secure or transport any objects within the deployment zone of the airbag systems, especially on the steering wheel, on the instrument panel, on the doors, on the windows, in the footwell, on the center armrest, or on the rear shelf.
- Never put stickers on the airbag system covers or cover them with any objects.
- Only lightweight clothing should be hung from the garment hooks in the vehicle. Do not use clothes hangers to hang clothing. The pockets of the clothing must not contain any heavy, breakable, or sharp-edged objects. This could impair the effectiveness of the side curtain airbags.
- You must not use seat or protective covers that are not specifically approved for use on Audi seats with side airbags. Since the side

airbags deploy from the seat backrest, such covers could impair the protective function of the side airbags.

- Applies to: vehicles with front center airbag: Do not use seat covers or protective covers that are not specifically approved for use on Audi seats with center airbags. The center armrest must be closed while driving. Otherwise, the protective function of the center airbag will be significantly impaired because it deploys from the driver's seat backrest.
- Damage to the original seat covers in the airbag deployment area must always be repaired by an authorized Audi dealer or authorized Audi Service Facility.
- Airbag system components are installed at various locations in your vehicle. Incorrect work or repairs on the vehicle could damage the airbag system components or impair their functionality. This may prevent the airbags from deploying or cause them to deploy incorrectly in the event of an accident, which increases the risk of serious or fatal injuries. Only have an authorized Audi dealer or authorized Audi Service Facility make repairs or modifications to a vehicle.
- The airbag system can only provide protection during one collision. If there is another collision, the airbag system will not deploy again. If the airbag system has deployed, have it replaced immediately by an authorized Audi dealer or authorized Audi Service Facility.
- Fine dust may appear if the airbags deploy. This is completely normal and does not indicate a fire in the vehicle. The fine dust can irritate the skin and mucous membranes in the eyes and can cause difficulty breathing, particularly for individuals who have or have had asthma or other health issues that affect breathing. Exit the vehicle or open the windows or doors to get access to fresh air.

Tips

If you are transporting children in the vehicle, read the information and follow the safety precautions ⇒ *page 85*.

Safety systems monitoring

The  indicator light in the instrument cluster monitors the safety systems such as the airbags (including the control modules, sensor, and wiring) and the belt tensioners. It turns on when you switch the ignition on and turns off after several seconds.

If the indicator light does not turn on when the ignition is switched on, does not turn off after several seconds, or turns on or flashes while driv-

ing, there may be a malfunction in one of the safety systems. Drive to an authorized Audi dealer or authorized Audi Service Facility immediately to have the malfunction corrected.

WARNING

Have the malfunction in the safety systems inspected immediately. Otherwise, there is a risk that the systems may not activate during an accident, which increases the risk of serious or fatal injury.

Description

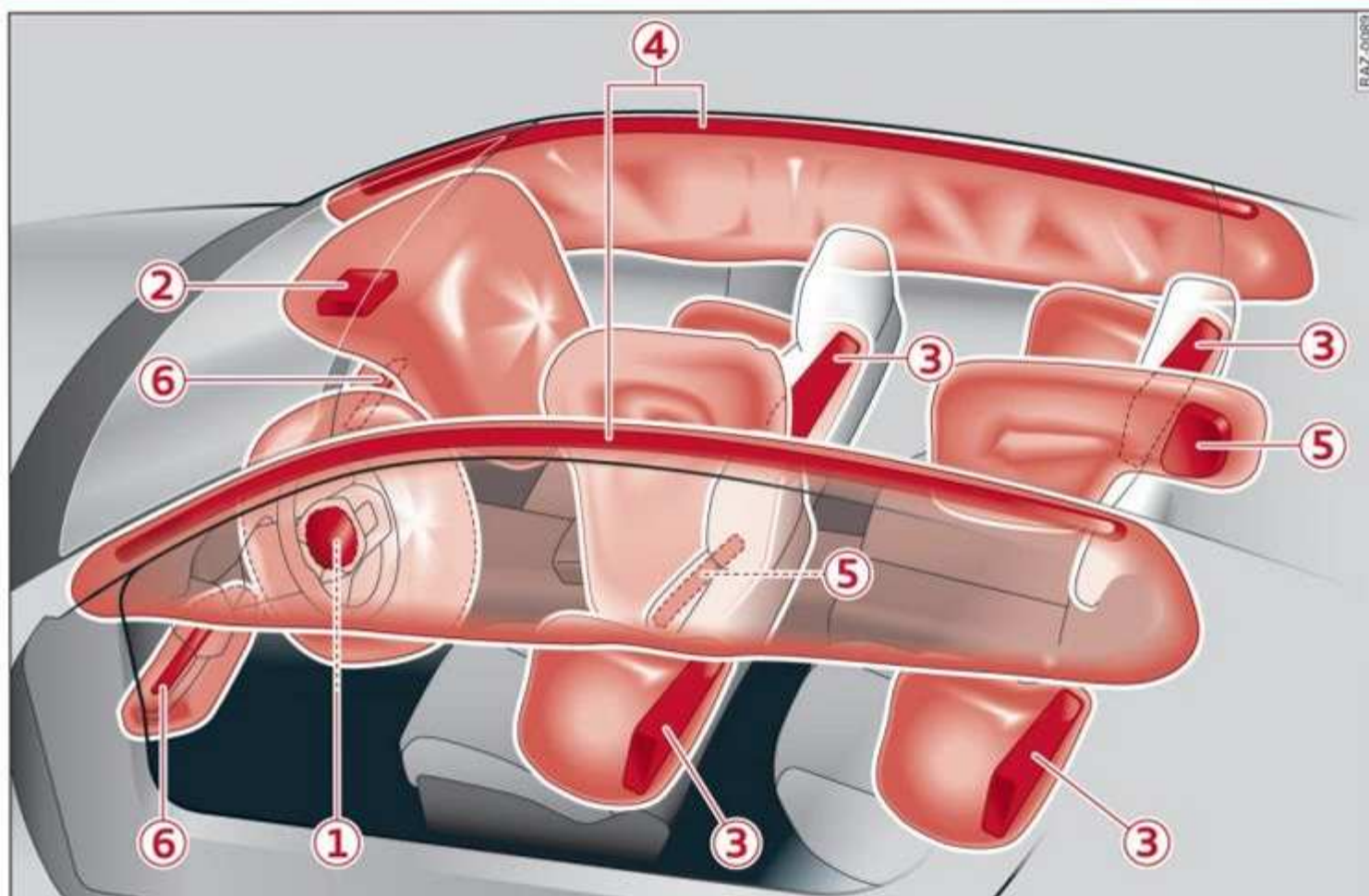

Fig. 69 Airbag overview image (enlarged section: deployed airbags)

The locations of the airbags are labeled with "AIRBAG". The following airbags are installed in your vehicle:

- ① Driver's airbag
- ② Front passenger's airbag
- ③ Front and rear side airbags
- ④ Head curtain airbag with ejection mitigation
- ⑤ Front and rear central airbags in some models
- ⑥ Knee airbags

Airbags offer the best possible protection in your vehicle during an accident when they are used together with safety belts that are fastened correctly, and when passengers are sitting in the correct seating position. Airbags are a supplementary restraint system and do not replace safety belts.

Airbags may deploy during front-impact, side-impact, or rollover accidents. ▶

The deployment area for the airbag system cannot be defined for every situation, since the circumstances surrounding accidents can vary widely. Factors that play an important role include the condition of the object that the vehicle hits (hard or soft), the angle of impact, vehicle speed, etc. The deciding factor for the deployment of the airbag system is the deceleration that occurs during an accident. Sensors in the vehicle are designed to detect the severity of an accident in conjunction with the control module, and to provide a targeted and timely deployment of the restraint system. If the vehicle deceleration that is measured during an accident is below the specified reference values in the control module, then the airbags will not deploy, even though the vehicle may be severely damaged from the accident. In these cases, the vehicle occupants will be protected by the safety belts if they are fastened and worn correctly.

The deployment of the front passenger's airbag will depend on the occupancy of the seat
⇒ page 83.

Each deployed airbag is filled with gas. When this occurs, the airbag covers open and the airbags unfold with great force into the deployment zone within milliseconds. Inflated airbags reduce the movement of persons in the vehicle who are wearing safety belts in the direction of the impact and thus help to reduce the risk of injury. They can help to protect the head, upper body, and lap, for example. However, there is the possibility that airbag deployment can cause injuries.

The airbag system only works when the ignition is turned on.

If you or other passengers in the vehicle have physical limitations that prevent sitting in a correct position, modifications to the vehicle may be necessary. For more information, contact an authorized Audi dealer or authorized Audi Service Facility, or call Audi customer support at 1-800-822-2834.

Tips

The side curtain airbags in your vehicle have ejection mitigation functions. This reduces

the risk of being ejected from the vehicle interior during an accident, especially in the event of a vehicle rollover.

Advanced airbag system



Fig. 70 Headliner: Indicator light to display the status of the front passenger's airbag



The Advanced Airbag System in your vehicle has been certified to comply with the requirements of the United States Federal Motor Vehicle Safety Standard (FMVSS) 208, as well as Canada Motor Vehicle Safety Standard (CMVSS) 208 as applicable at the time your vehicle was manufactured. According to these requirements, the front Advanced Airbag System on the passenger's side has been certified for "suppression" for infants approximately 12 months old and younger, and for "low risk deployment" for children aged 3 to 6 years old (as defined in the standard).

The advanced airbag system will activate or deactivate the front passenger's airbag based on the occupancy of the seat. If a front airbag deploys during a collision, the deployment force will adapt to the person in the vehicle.

Components

The advanced airbag system consists of the following components:

- Front airbags in the steering wheel and in the instrument panel on the front passenger's side: these can protect persons in the front seats during a collision
- Passenger occupant detection sensor in the front passenger's seat: this detects if the front passenger's seat is occupied (for example, by a person or a small child in a child safety seat) ▶

- Seat position sensors on the front seats: these determine the distance between the seat and the steering wheel or instrument panel
- Sensors in the front safety belt latch: these detect if the safety belts are fastened
- PASSENGER AIR BAG OFF  ON  indicator light in the headliner: this indicates if the front passenger's airbag is activated or deactivated
-  Indicator light in the instrument cluster: this monitors the function of the Advanced Airbag System components to ensure they are functioning correctly

How the components function together



The passenger occupant detection sensor in the front passenger's seat detects if the front passenger's seat is occupied. The passenger occupant detection sensor measures the electrical capacity on the front passenger's seat. The passenger's airbag is activated or deactivated depending on the electrical capacity that is measured.

The passenger's airbag is activated if:

- The electrical capacity is higher than the threshold stored in the control module
- The electrical capacity is the same as or greater than the electrical capacity of a typical adult

The passenger's airbag is deactivated if:



- The electrical capacity is lower than the threshold stored in the control module
- The electrical capacity is the same as or less than the electrical capacity of a typical one-year-old child in a child safety seat that has been used for certification in accordance with FMVSS 208



If the front passenger's airbag is activated, the PASSENGER AIR BAG ON  indicator light will turn on. If the front passenger's airbag is deactivated, the PASSENGER AIR BAG OFF  indicator light will turn on.

The deployment force of the front airbags adapts based on whether or not the safety belt is used and the distance between the seat and the steering wheel/instrument panel. For example, if a person is too close to the front airbag, the front



airbag will deploy with less force to help reduce the risk of injury.

Meaning of PASSENGER AIR BAG OFF ON indicator light





When the ignition is switched on, the system detects whether the front passenger's seat is occupied. PASSENGER AIR BAG OFF  ON  will turn on for several seconds during this process. Then it will indicate whether the front passenger's airbag is activated or deactivated.

- PASSENGER AIR BAG OFF : the front passenger's airbag is deactivated and will not deploy in the event of an accident.
- PASSENGER AIR BAG ON : the front passenger's airbag is activated and could deploy in the event of an accident.

If a change to the occupancy status of the front passenger's seat is detected

PASSENGER AIR BAG OFF  ON  will flash for several seconds and will then display the status of the front passenger's airbag.



Always make sure the indicator light corresponds to the occupancy of the front passenger's seat.



- **An adult or individual of similar size in the front passenger's seat:** the front passenger's airbag must be activated, therefore PASSENGER AIR BAG ON  must remain turned on.
- **An individual of smaller size (for example, an adolescent or small adult) in the front passenger's seat:** the front passenger's airbag must be activated, so PASSENGER AIR BAG ON  must stay on.
- **Child in a child safety seat on the front passenger's seat:** the front passenger's airbag must be deactivated, so PASSENGER AIR BAG OFF  must stay on.
- **Front passenger's seat not occupied:** the front passenger's airbag must be deactivated, so PASSENGER AIR BAG OFF  must stay on.

WARNING

- An adult or a person with a small stature (such as a young person or small adult) seated on the front passenger's seat will not be

protected by the passenger's airbag in the event of a collision if the passenger's airbag is deactivated. This increases the risk of injury and death. Always make sure that **PASSENGER AIR BAG ON**  remains on while driving. If

PASSENGER AIR BAG ON  does not turn on, make sure the front passenger is sitting correctly in the seat \Rightarrow page 67 and that there is nothing covering the front passenger's seat (such as blankets or pillows). If **PASSENGER AIR BAG ON**  still does not turn on, the front passenger's seat must not be used. Drive to an authorized Audi dealer or authorized Audi Service Facility and have the airbag system inspected.

- A child in a child safety seat on the front passenger's seat - especially in a rear-facing child safety seat - can receive a severe impact if the front passenger's airbag deploys, which increases the risk of serious or fatal injury. Always secure child safety seats on the rear seats. If special circumstances require the use of a child safety seat on the front passenger's seat, always make sure that **PASSENGER AIR BAG OFF**  stays on while driving. If **PASSENGER AIR BAG OFF**  does not turn on, remove the child safety seat and install it again according to the child safety seat manufacturer instructions. If **PASSENGER AIR BAG OFF**  still does not turn on, the front passenger's seat must not be used. Drive to an authorized Audi dealer or authorized Audi Service Facility and have the airbag system inspected.
- Fluids, electronic devices, or mechanical damage on the front passenger's seat may cause the front passenger seat occupant detection to malfunction. The system may then incorrectly detect if the front passenger's seat is occupied. As a result, it could deploy the front passenger's airbag incorrectly or fail to deploy it, which increases the risk of serious or fatal injury. Make sure that no wet objects (such as a wet hand towel) and no fluids come into contact with the front passenger's seat cushion. If the front pas-

senger's seat becomes wet, dry it immediately. Make sure no electronic devices (such as a laptop or a retrofitted seat heater) are on the front passenger's seat. Do not transport any objects on or under the front passenger's seat.

- Seat covers or protective covers may prevent the advanced airbag system from correctly detecting child safety seats or persons in the front passenger's seat. You must not use seat covers or protective covers on the front passenger's seat that are not specifically approved for use on Audi seats with an advanced airbag system.

Child safety seats

General information

When installing and using child safety seats, follow the information in this Owner's Manual, the applicable state and federal regulations, and the manufacturer instructions for the child safety seat.

You can also obtain useful and current information from the following sources:

U.S. National Highway Traffic Safety Administration

<http://www.nhtsa.gov>
<http://www.safercar.gov>

National SAFE KIDS Campaign

<http://www.safekids.org>

SafetyBeltSafe U.S.A.

<http://www.carseat.org>

Transport Canada Information Centre

<http://www.tc.gc.ca/roadsafety>



Audi Customer Experience Center

<https://www.audiusa.com/help/contact-us>
<https://www.audi.ca/ca/web/en/models/layer/contact.html>

WARNING

To reduce the risk of serious or fatal injuries, children must always be secured in the vehicle with a child safety seat that is appropriate for their body size, weight, and age.

- Children ages 12 and under must be transported using the appropriate child safety seat. Note differences in regulations between states and countries.
- Child safety seats secured incorrectly in the vehicle may cause serious or fatal injuries in the event of an accident. Always secure the child safety seat according to the manufacturer instructions.
- Children or babies must not under any circumstances be held on the lap of the driver or other passengers while driving.
- Do not secure more than one child in a child safety seat.
- Never allow a child to sit in a child safety seat unsupervised.
- Never allow children to ride unsecured in the vehicle or to stand or kneel on the seats while driving. In the event of an accident, a child could be propelled through the vehicle. This can result in serious or fatal injuries to the child and passengers.
- If children use an incorrect seating position while driving, they have a higher risk of injury during a sudden braking maneuver or accident. This especially applies to children in the front passenger's seat or children who have their head near the side airbag deployment area, if the airbag system is deployed during an accident. This incorrect seating position can cause severe or even fatal injuries.
- Make sure there is enough space in front of the child in the child safety seat. If necessary, adjust the angle and position of the seat in front of the child safety seat.
- The rear side of a forward-facing child safety seat should be positioned as close as possible to the backrest on the vehicle seat. If the head restraints make it difficult to install a child safety seat, adjust or remove them if necessary ⇒ page 75. Reinstall the head restraints immediately once the child safety seat has been removed.
- NEVER use a rear-facing child safety seat on a seat with an ACTIVATED FRONT AIRBAG; this could cause DEATH or SERIOUS INJURIES to a CHILD.

- Always secure child safety seats on the rear seats. If exceptional circumstances require the child safety seat to be placed on the front passenger's seat, then the front passenger's airbag must be deactivated. Always make sure that **PASSENGER AIR BAG OFF**  stays on while driving. If **PASSENGER AIR BAG OFF**  does not turn on, remove the child safety seat and install it again according to the child safety seat manufacturer instructions. If **PASSENGER AIR BAG OFF**  still does not turn on, the front passenger's seat must not be used. Drive to an authorized Audi dealer or authorized Audi Service Facility and have the airbag system inspected.
- If you must use a forward-facing child safety seat on the front passenger's seat, move the seat as far back as possible so that it is as far as possible from the front passenger's airbag. While doing this, make sure the seat can be adjusted all the way. A child in a child safety seat on the front passenger's seat can receive a severe impact if the front passenger's airbag deploys, which increases the risk of serious or fatal injury.
- Replace the child safety seat after an accident because there could be damage that is not visible.
- Even if a child is not sitting in the child safety seat, the child safety seat must be secured. An unsecured child safety seat may be thrown through the vehicle interior during sudden braking maneuvers or an accident.

Correct positioning for children

Always secure children in a child safety seat designed for the body size, weight, and age of the child.

You can secure child safety seats in your vehicle using the lower LATCH anchors or the safety belts. You can also secure child safety seats to the top tether anchor. Depending on the child safety seat, it may also be necessary to secure it ►

to the top tether anchor. In Canada, securing forward-facing child safety seats to the top tether anchors is required by law.

Always transport children in the rear seats

Accident statistics show that children that are secured correctly in the rear seats are safer than in front seats. Always transport children in suitable child safety seats secured on the rear seats.

In exceptional circumstances: transporting children in the front passenger's seat

If exceptional circumstances require the child safety seat to be placed on the front passenger's seat, then the front passenger's airbag must be deactivated. Please note the important information for this ⇒ *page 83, Advanced airbag system*. If you must secure a forward-facing child safety seat, move the front passenger's seat as far back as possible so that it is as far as possible from the front passenger's airbag. While doing this, make sure the seat can be adjusted all the way.

Only switch to a larger child safety seat when absolutely necessary

Switch to a larger child safety seat only when absolutely necessary. Secure your child using a safety belt without a child safety seat only if all of the following statements are true:

- The child is large enough to sit upright in the seat
- The child is able to sit with their back resting completely on the seat backrest
- The child is able to sit with their knees angled over the edge of the seat surface
- The child is able to sit with both of their feet completely touching the floor in the footwell
- The lap portion of the safety belt lies flat and securely over the hip area and never over the stomach
- The shoulder portion of the safety belt lies flat and securely over the center of the shoulder and the chest, and never under the arm, behind the back, or over the neck or face.
- The child is able to maintain this seating position throughout the entire trip

Read and follow the important information and warnings regarding the correct use of safety belts ⇒ *page 77*.

i Tips

- Child safety seats can also be secured to seats with side airbags. In the event of an accident, children can also be protected by the side airbags if the child is correctly secured in a suitable child safety seat that is attached correctly.
- The lower LATCH anchors as well as the safety belt may be required to correctly install some child safety seats. Using both at the same time is permitted, provided that the fastening systems or safety belts do not impair those in an adjacent seating position.
- All child safety seats are constructed so that they can be secured using the lap safety belt in the vehicle.
- Child safety seats with a load leg can only be secured to the outer rear seats and to the front passenger's seat.

Securing child safety seats to the lower LATCH anchors



Fig. 71 Rear bench seat: marker points and lower LATCH anchors

Observe the safety precautions ⇒ *page 85*.

In the United States and Canada, child safety seats can be secured without safety belts using the LATCH system. LATCH stands for Lower Anchors and Tethers for Children. In Canada, similar systems are called UCRA, LUAS, or UAS.

The lower LATCH anchors in your vehicle are located on the outer seats of the rear bench seat between the seat surface and the backrest. These ►

seating locations each have two lower LATCH anchors that can be used to secure a LATCH child safety seat. Marking points with a \Rightarrow *fig. 71* symbol are located on the backrest of the rear bench seat. You can locate the LATCH anchors using the marking points.

- ▶ Applies to: vehicles with power-adjustable rear bench seat: Move the rear seat all the way back and downward and position the backrest so it is as upright as possible.
- ▶ Activate the child safety lock \Rightarrow *page 49*.
- ▶ If you secure a child safety seat to the rear seat, secure any unused safety belts that are within reach of the child \Rightarrow  in *Securing child safety seats with a safety belt on page 89*.
- ▶ Secure the child safety seat according to the child safety seat manufacturer instructions.
- ▶ Pull on the child safety seat to check if both sides are engaged correctly in the LATCH anchors.
- ▶ If possible, also secure the child safety seat to the respective top tether anchor on the seat \Rightarrow *page 89*.

WARNING

The LATCH anchors in the vehicle are only designed for child safety seats with the LATCH system. To reduce the risk of serious or fatal injury, never secure other child restraint systems, belts, or objects to the anchors.

Tips

The LATCH anchors are designed for a total weight (child and child safety seat combined) up to 65 lbs (29 kg). If the total weight is greater than this, the child safety seat must be secured with the vehicle safety belt.

Securing child safety seats with a safety belt

Observe the safety precautions \Rightarrow *page 85*. The front passenger's seat is a dangerous location for a child, even with an advanced airbag system. If exceptional circumstances require the child safety seat to be placed on the front passenger's seat, then the front passenger's airbag must be deactivated. Please note the important informa-

tion for this \Rightarrow *page 86, Correct positioning for children* and \Rightarrow *page 83, Advanced airbag system*.

Securing child safety seats

- ▶ Applies to: vehicles with power-adjustable rear bench seat: If you secure a child safety seat to the rear seat, move the rear seat all the way back and downward and adjust the backrest to be as upright as possible.
- ▶ Activate the child safety lock \Rightarrow *page 49*.
- ▶ If you secure a child safety seat to the rear seat, secure any unused safety belts that are within reach of the child \Rightarrow  \Rightarrow *page 90*.
- ▶ If you secure a child safety seat to the front passenger's seat, adjust the front passenger's seat to the highest position.
- ▶ Secure the child safety seat according to the child safety seat manufacturer instructions.
- ▶ If necessary, activate the belt retractor lock \Rightarrow *page 88, Activating the belt retractor lock*.
- ▶ If the child safety seat is secured on the front passenger's seat, adjust the front passenger's seat backrest until it rests flat against the child safety seat. Also make sure that the upper safety belt fixture is behind the child safety seat.
- ▶ If you secure a child safety seat on the rear seat, also secure it to the correct top tether anchor if possible \Rightarrow *page 89*.

Activating the belt retractor lock

If you secure a child safety seat using the vehicle safety belt, you must activate the belt retractor lock. Follow the child safety seat manufacturer instructions.

The belt retractor lock prevents the safety belt from becoming loose while driving, which could result in the child safety seat no longer being adequately secured.

- ▶ Secure the child safety seat according to the child safety seat manufacturer instructions. While doing so, pull out the safety belt. Insert the safety belt into the belt latch that belongs to that seat until it audibly locks.
- ▶ Pull the upper belt out completely and then allow it to retract. You will hear a clicking sound while the belt is retracting. It will not be possible to pull the safety belt out any farther. ▶

- ▶ Push the child safety seat into the seat and allow the belt to retract more.
- ▶ Make sure that the child safety seat cannot move more than 1 inch (2.5 cm).

Deactivating the belt retractor lock

- ▶ Unbuckle the safety belt from the belt latch.
- ▶ Remove the child safety seat according to the manufacturer instructions.
- ▶ Allow the safety belt to retract completely. The belt retractor lock is deactivated.

WARNING

- A safety belt that is not locked by the belt retractor lock or a locking device cannot secure a child safety seat while driving or in the event of an accident, which increases the risk of fatal injury. Always make sure the belt retractor lock on the safety belt is activated if the child safety seat manufacturer instructions require it.
- Due to the risk of fatal injury, never place a rear-facing child safety seat on the front passenger's seat when the front passenger's airbag is switched on.
- For the child safety seat to offer the maximum protection, it is especially important to route the vehicle safety belt correctly. Always follow the instructions from the child safety seat manufacturer for routing the safety belt correctly. Incorrectly fastened safety belts can cause injuries, even during minor accidents.

Additionally securing a child safety seat to the top tether anchor



Fig. 72 Rear shelf: top tether anchors to secure a child safety seat with an upper belt

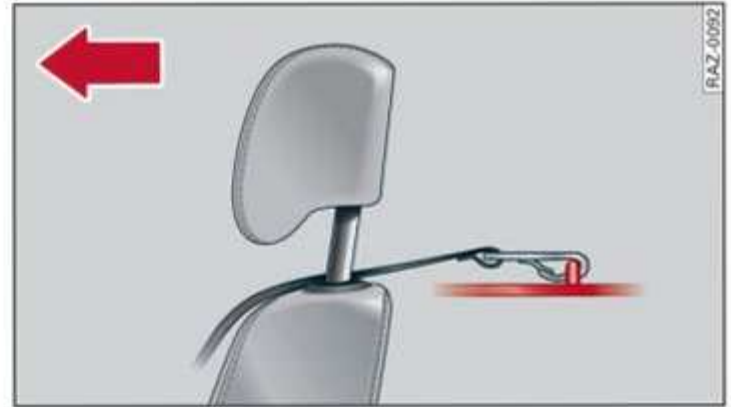

Fig. 73 Rear shelf: securing the upper belt to the top tether anchor

Observe the safety precautions ⇨ page 85.

There is a top tether anchor behind every seat in the rear bench seat to additionally secure a child safety seat with an upper belt. Depending on the vehicle equipment, there may be two or three top tether anchors.

- ▶ Applies to: head restraints on the outer rear seats: Adjust the head restraints behind the child safety seat upward.
- ▶ Applies to: head restraint on the center rear seat: Fold the head restraint downward.
- ▶ Lift the cover for the top tether anchor upward.
- ▶ Secure the child safety seat according to the child safety seat manufacturer instructions.
- ▶ Applies to: head restraints on the outer rear seats: Guide the child safety seat upper belt toward the rear, either under the head restraint or next to it on both sides (depending on the version of the child safety seat).
- ▶ Applies to: head restraint on the center rear seat: Guide the child safety seat upper belt toward the rear over the head restraint.
- ▶ Fasten the belt to the top tether anchor ⇨ fig. 73. While doing this, make sure the belt is not twisted and is not running over any sharp edges.
- ▶ Pull the belt tightly so that the child safety seat rests at the top of the seat backrest.
- ▶ Applies to: head restraints on the outer rear seats: Adjust the head restraints behind the child safety seat downward if necessary.

WARNING

The top tether anchors in the vehicle are only designed for child safety seats equipped with

an upper strap. To reduce the risk of serious or fatal injury, never secure other child restraint systems, belts, or objects to the anchors.

so that they are not within reach of children in child safety seats.

Securing unused safety belts on the rear bench seat



Fig. 74 Rear bench seat: securing unused safety belts

If a child safety seat is used on the rear bench seat, the child must not be able to reach any safety belts that are not being used. Secure safety belts that are within reach of the child.

- ▶ If you secure a child safety seat to the LATCH anchors, fasten the safety belt on the seat where the child safety seat is installed using the seat's safety belt latch.
- ▶ Applies to: vehicles with three seats on the rear bench seat: If a child safety seat is secured on one of the outer seats, fasten the safety belt for the center seat in the center seat's latch.
- ▶ Activate the belt retractor lock on the fastened safety belts. To do this, pull the upper belt out completely and then allow it to retract. You will hear a clicking sound while the belt is retracting. It will not be possible to pull the safety belt out any farther.
- ▶ Make sure the fastened safety belt does not block access to the LATCH anchors. Otherwise, it may not be possible to secure the child safety seat to the LATCH anchors correctly.

WARNING

A child in a child safety seat could play with the unused safety belts and then become entangled in them, which increases the risk of fatal injury. Always secure unused safety belts

Storage and convenience

Power sources

When the ignition is switched on, you may be able to use multiple power sources for external devices, depending on the vehicle equipment.



12 volt sockets

You can connect electrical accessories to the 12 volt sockets. The power usage from the sockets must not exceed a total of 120 watts. Do not connect multiple devices to the sockets in the vehicle at the same time.

The 12 volt sockets are labeled with the 12V symbol. They are located at the front and rear of the center console and on the side trim panel in the luggage compartment*.

USB ports

Applies to: vehicles with USB ports

You can charge mobile devices using the USB ports. Depending on the vehicle, the USB ports may be labeled with one of the following symbols: , , or CHARGE ONLY.

115 volt socket

Applies to: vehicles with 115 volt socket

The socket is located in the rear center console and can be used for electrical devices . The power usage must not exceed 150 watts.

When you push the device connector all the way into the socket, the child safety mechanism releases and there is electric current.

- If the LED on the socket is green or flashes slowly, then the socket is ready for use.
- If the LED is red and flashes quickly, there is a malfunction in the connected device or the socket is too hot. The socket will switch off for safety reasons. To reactivate the socket, remove the device connector. Connect the device after correcting the malfunction or reconnect after a brief cool-down period.

WARNING

- To reduce the risk of fatal injury, store all connected devices securely when driving so that they do not move around inside the ve-

hicle when braking or in the event of an accident.

- Incorrect usage can lead to serious injuries or burns. To reduce the risk of injuries, never leave children unattended in the vehicle with the vehicle key.

WARNING

Applies to: vehicles with 115 volt socket

- To reduce the risk of fatal injury, do not insert any conductive objects, such as knitting needles, into the contacts on the socket.
- To reduce the risk of fatal injury, do not spill any fluids on the socket. Should any moisture enter the socket, make sure that it has dried out completely before using the socket again.
- If devices or connectors that are heavy (such as a power supply unit) are attached directly to the socket, the holder can become damaged, which increases the risk of injury.
- Using adapters and extension cables increases the risk of injury because they override the safety devices for the socket.
- To reduce the risk of injury, remove the connector of the connected device if the socket has switched off due to a malfunction.

Note

- Read the operating manuals for the connected devices.
- To reduce the risk of damage to the vehicle electrical system, never attempt to charge the vehicle battery by connecting accessories that provide power to the power sources.
- Do not connect any device whose network class (voltage) does not match the network class designed for the socket.
- Disconnect the connectors from the power sources carefully to reduce the risk of damaging them.

Tips

Applies to: vehicles with 115 volt socket

- Devices that are not shielded or devices near the rear window antenna can cause

malfunctions in the radio or vehicle electrical system.

- The functions on some devices may be limited due to the low power output.
- With some power supply units, the integrated overcurrent protection may prevent it from switching on. In this case, disconnect the power supply unit from the electrical equipment and reconnect after approximately 10 seconds.

i Tips

Do not connect any other devices to the sockets when using the compressor* provided by the factory ⇒ *page 300*. The power consumption in the sockets may be temporarily exceeded when using the compressor*.

Cup holders

Applies to: vehicles with cup holders



Fig. 75 Front center console: cup holder

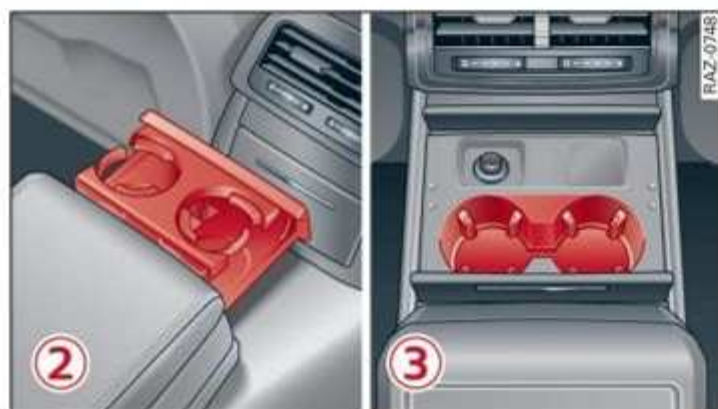

Fig. 76 Rear center armrest and rear center console: cup holder

Cup holders in the front center console

The cup holder ① may be under a cover.

- ▶ To open the cup holder, tap on the strip on the cover.

Cup holders in the rear center armrest

- ▶ Fold the center armrest downward.
- ▶ To open the cup holder ②, tap on the cover on the front side.
- ▶ To close the cup holder, push the cup holder all the way back into the slot.

Cup holders in the rear center console*

- ▶ To open the cup holders ③ in the rear center console, tap on the cover.

⚠ WARNING

- Do not put any hot beverages in the cup holder while the vehicle is moving. Hot beverages could spill, which increases the risk of injury.
- Do not use any breakable beverage containers (for example, made out of glass or porcelain). You could be injured by them in the event of an accident.

! Note

Beverage containers in the cup holders should always have a lid. Otherwise, the liquid inside could spill and cause damage to vehicle equipment.

Storage and compartments

Cooled glove compartment

Applies to: vehicles with cooled glove compartment

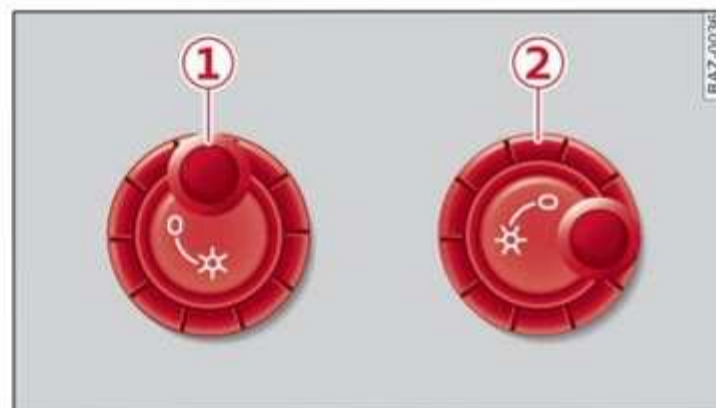

Fig. 77 Glove compartment: cooling mode knob

- ▶ To switch the refrigeration function on, turn the knob counterclockwise until the symbols indicate that refrigeration is switched on ①.

- ▶ To switch the refrigeration function off, turn the knob clockwise until the symbols indicate that refrigeration is switched off ②.

i Tips

The glove compartment cooling mode only functions when the vehicle A/C system is switched on.

Folding tray tables

Applies to: vehicles with folding tray tables



Fig. 78 Rear center console*: opening the folding tray table



Fig. 79 Rear center console*: extending and adjusting the folding tray table

Opening and closing the folding tray table

- ▶ Press the button forward on the center armrest and fold the center armrest upward.
- ▶ Fold the tray table arm upright and all the way forward ①.
- ▶ Tilt the tray table toward the seat ② and fold the tray table to the side in the horizontal direction ③.
- ▶ Slide the tray table outward ④.
- ▶ Unfold the tray table. If necessary, the horizontal angle of the tray table can be adjusted. To do this, press the lever ⑤ on the side of the tray upward.

- ▶ To fold the table in, perform all of the steps in reverse order.

! WARNING

- Do not open the folding tray table while driving. In the event of an accident or sudden braking or swerving, vehicle occupants could collide with the tray tables, and objects placed on the tables could be thrown through the vehicle interior, increasing the risk of injury.
- To reduce the risk of pinching, open the folding tray table carefully.
- Be careful when adjusting the front seats. To reduce the risk of pinching, pay attention to the rear passengers when the folding tray tables are open.

! Note

Be very careful when adjusting the front seats to avoid damaging the folding tray tables or seats.

Storage area behind the rear head restraints

Applies to: vehicles without rear center airbag:
The storage area can be used to carry light pieces of clothing.

! WARNING

The storage compartment must not be used to transport heavy objects, hard objects, or animals. Such objects endanger persons in the vehicle and increase the risk of injury during sudden driving or braking maneuvers or in an accident.

! Note

Make sure that the heating grid strips for the rear window defogger are not damaged by abrasive objects.

i Tips

To ensure the ventilation functions correctly, the ventilation slots between the rear window and the storage area must not be covered.

Additional storage compartments

Depending on vehicle equipment, there are a variety of storage areas, compartments, and retainers, such as the glove compartment, for safely storing and securing objects.

WARNING

- To reduce the risk of injury, make sure all storage compartments are always closed while driving.
- Loose objects can be thrown around the vehicle interior during sudden driving or braking maneuvers, which increases the risk of an accident. Store objects securely while driving.
- Only use the storage compartments in the door trim panels to store small objects that will not stick out of the compartment and impair the function of the side airbags.
- Only lightweight clothing should be hung from the garment hooks in the vehicle. Do not use clothes hangers to hang clothing. The pockets of the clothing must not contain any heavy, breakable, or sharp-edged objects. This could impair the effectiveness of the side curtain airbags.
- Make sure your view toward the rear is not blocked, for example by hanging clothing or objects in the vehicle.

Luggage compartment

General information

All pieces of luggage or objects must be securely fastened in the luggage compartment. Note the following to maintain good vehicle handling:

- ▶ Distribute the load evenly in the luggage compartment.
- ▶ Stow heavy luggage as far forward in the luggage compartment as possible.
- ▶ Use non-elastic cords attached to the tie-downs to secure objects.

WARNING

- Loose objects can be thrown around the vehicle interior during sudden driving or brak-

ing maneuvers, which increases the risk of an accident. Always stow objects securely in the luggage compartment and secure them at the tie-downs. Use straps suitable for heavy objects.

- If pieces of luggage or objects are secured to the tie-downs with unsuitable or damaged straps, this can increase the risk of injury during braking maneuvers or accidents.
- When transporting heavy objects, the vehicle characteristics will change due to the shift in the center of gravity, which increases the risk of an accident. You may need to adapt your driving style and speed to the current conditions.
- Never exceed the permitted axle and load and vehicle weight ⇒ *page 324*.
- Never secure a child safety seat to the tie-downs.
- Never leave your vehicle unattended, especially if the luggage compartment lid is open. Children could enter the luggage compartment and close the luggage compartment lid from the inside. This creates the risk of fatal injury, since the children would be locked inside and may not be able to escape by themselves.
- Do not allow children to play in or on the vehicle. Close and lock the luggage compartment lid as well as all other doors when you leave the vehicle.
- Never transport persons in the luggage compartment. Each person in the vehicle must be secured correctly in the vehicle using the safety belts ⇒ *page 77*.
- For stability reasons, the bag hooks* can hold a maximum weight of 6.6 lbs (3 kg). Heavier objects are not adequately secured. There is risk of personal injury.

Note

Make sure that the heating grid strips for the rear window defogger are not damaged by abrasive objects.

i Tips

- The tire pressure must be adapted to the load ⇒ *page 280*.
- You can purchase straps at specialty stores.

Pass-through

Applies to: vehicles with pass-through



Fig. 80 Rear bench seat with three seats: opening the cover



Fig. 81 Rear bench seat with two seats: lowering the cover

- ▶ Applies to: vehicles with three rear seats: Fold down the center armrest in the rear and the cover behind it.
- ▶ Applies to: vehicles with two rear seats: Press the button ① and the cover will move down automatically ②.

Tie-downs

Fig. 82 Luggage compartment: location of the tie-downs

Observe the safety precautions ⇒ *page 94*.

Tie-downs

There are tie-downs ① in the luggage compartment to secure pieces of luggage and objects.

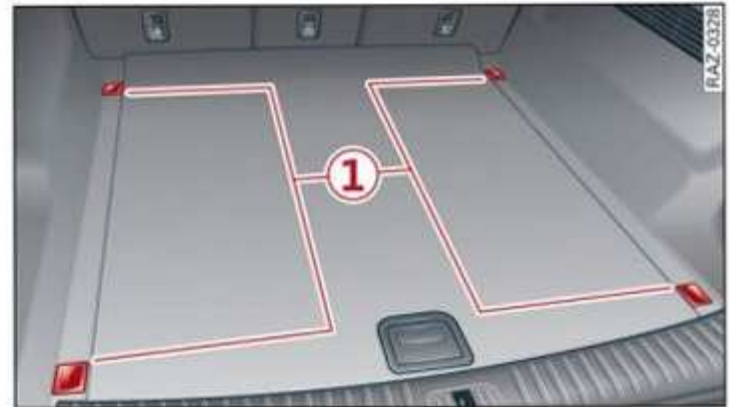
- ▶ Use the tie-downs to secure the cargo.

Roof rack**General information**

Applies to: vehicles with roof rack mount

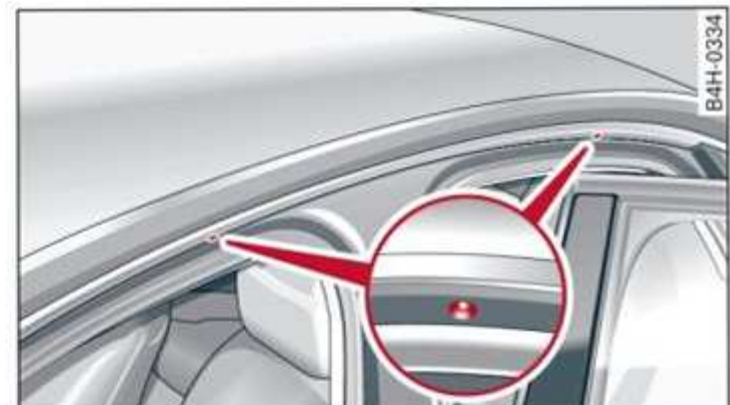

Fig. 83 Roof: mounting points

If luggage or cargo is to be carried on the roof, you must observe the following:

- These roof racks are the basis for a complete roof rack system. Only roof racks that are suitable for your vehicle may be used. Audi recommends roof racks and attachments from the Audi Genuine Accessories program.
- Make sure the roof rack is mounted on the vehicle only at the specified locations ⇒ *fig. 83*.
- Note the permitted axle load, permitted total weight, and permitted roof load of your vehicle ⇒ *page 324*. The roof load is the total of the weight of the roof rack, the attachments and

the cargo you are carrying. However, you must also note the permitted load of the carrier system being used.

WARNING

- Follow the installation instructions provided with the roof rack system. If you do not secure the roof rack system and objects on the roof correctly, they could come loose from the vehicle and cause an accident.
- The risk of an accident increases when using a roof rack system, because it changes the driving characteristics by shifting the center of gravity and/or the increasing the surface area exposed to wind. You may need to adapt your driving style and speed to the current conditions.

Note

Make sure that the luggage compartment lid and the panoramic glass roof* do not come into contact with objects on the roof when they are open.

For the sake of the environment

Energy usage will increase because of the increased wind resistance. Remove the roof rack when you are no longer using it.

Warm and cold

Climate control system

Description

Your vehicle has a deluxe automatic climate control system with four zones where the temperature, air distribution, and amount of air can be adjusted separately at every seat.

The climate control system warms, cools, dehumidifies, and filters the air in the vehicle interior. It is the most effective when the windows and, depending on vehicle equipment, the roof are closed. If there is a build-up of heat inside the vehicle, ventilation can help to speed up the cooling process.

The deluxe climate control system automatically maintains a temperature once it has been set. In all heating mode functions except defrost, the blower only switches to a higher speed once the coolant has reached a certain temperature.

Active combination filter

When the fan is running, the filter will reduce particulate matter and the concentration of pollen, as well as odors in the interior.

i Tips

- To prevent interference with the heating or cooling output and to prevent the windows from fogging over, the air intake in front of the windshield must be free of ice, snow, and leaves.
- Condensation from the cooling system can drip and form a puddle of water under the vehicle. This is normal and does not mean there is a leak.
- The energy management system may temporarily switch off certain functions, such as the seat heating or rear window defogger. These systems will be available again once the energy supply has been restored.

Operation



Fig. 84 Center console: lower display and switch panel

The settings can be adjusted using both displays, the switch panel in the center console and, depending on the vehicle equipment, using the control panel in the rear or the Rear Seat Remote display. For information on how to operate the touch displays, see ⇒ page 20, *Touch displays*.

You can adjust all climate control system settings in the front; only certain functions are available in the rear.



Lower display

The lower display has two sections with controls:

You can regulate the blower and the air distribution automatically using AUTO in area ①. You can also apply individual settings here.

In area ②, you can switch individual climate control system functions on and off.

Switch panel in the center console

Both the  and  buttons to defog windows as quickly as possible are located in area ③.

Upper display

In the upper display, you can switch additional functions on and off, display them, and adjust settings.

- ▶ Applies to: MMI: Select on the home screen: **VEHICLE > Air conditioning**, or
- ▶ Press **...** on the lower display.

Rear Seat Remote

Applies to: vehicles with Rear Seat Remote

Using the Rear Seat Remote, you can also control certain climate control system functions from the rear. ▶

Control panel in rear

You can operate certain climate control functions in the rear using the control panel.

Customizing

A climate control function from the upper display can be assigned to each button to the left and right of **...** in area ②.

- ▶ Press and hold the symbol for the desired function on the upper display for at least three seconds. A menu that consists of two sections appears.
- ▶ If you pull the symbol toward the left section, the button to the left of **...** will be assigned.
- ▶ If you pull the symbol toward the right section, the button to the right of **...** will be assigned.

Settings

Press the buttons to turn the functions on or off. One bar in the button or the LED in the button will light up when the function is switched on. Some buttons can have several functions assigned to them. The various functions can be activated by pressing the button multiple times.

AUTO Automatic mode

The automatic mode regulates the amount of air and air distribution automatically, so that the set temperature is reached as quickly as possible.

REAR Rear climate control system

To enable operation of the climate control system from the rear of the vehicle, press REAR.

To exit this mode again, press REAR or REAR MODE EXIT.

SYNC Synchronization

When synchronization is switched on, the temperature, air distribution, and blower strength on the driver's side is applied to all seat positions. You can also control the synchronization directly using a gesture. Pull two fingers together on the lower display ⇒ *page 20*.

OFF Switching off

The climate control system is switched off. Air supply from the outside is blocked. If you press OFF in the front, the front and rear climate control system will switch off. Depending on vehicle equipment, you can press OFF in the rear control panel to switch the rear climate control system off. To switch the climate control system back on, press on any button in the respective display.

A/C / ^{A/C}_{MAX} Cooling mode

The cooling mode only functions with the blower turned on. The air is not cooled and humidity is not reduced when cooling mode is switched off. This can cause fog on the windows. The cooling mode switches off automatically at low outside temperatures.



If you activate the A/C, the cooling mode will be automatically regulated.

If you activate ^{A/C}_{MAX}, the cooling mode will run with maximum cooling output and maximum blower speed. To reduce unnecessary energy usage, only use this function briefly.

+ / - Temperature



Temperatures between 60 °F (+16 °C) and 84 °F (+28 °C) can be set. If outside of this range, **LOW** or **HIGH** will appear in the display. In both settings, the climate control runs constantly at the maximum cooling or heating level. The temperature is not regulated.

Blower

With  / , you can manually adjust the volume of air generated by the blower to your preferences. The blower should always run at a low setting to prevent the windows from fogging and to ensure a continuous exchange of air inside the vehicle. To have the blower regulated automatically, press AUTO.

Air distribution

To prevent the side windows from fogging over, open the side air vents and angle them toward the side.

With  /  / , you can select the vents from which the air will flow. To have the air

distribution controlled automatically, press the AUTO button or deactivate all three arrows. With , the air will be directed toward the windshield.

Using the control panel in the rear, you can adjust the air distribution based on the direction of the arrow by pressing the  button multiple times.

Defrosting

The windshield and side windows are defrosted or cleared of condensation as quickly as possible. Align the outer air vents with the side windows. The maximum amount of air flows mainly from the vents below the windshield. Recirculation mode switches off. The temperature should be set at 72 °F (+22 °C) or higher. Depending on the outside temperature, the A/C cooling mode may automatically switch on.

Rear window defogger



The rear window defogger only operates when the engine is running. It switches off automatically after 10 to 20 minutes, depending on the outside temperature.

To prevent the rear window defogger from switching off automatically, press and hold the  button for more than three seconds. It will remain on until the ignition is switched off.



/ Recirculation mode

In recirculation mode, the air inside the vehicle is circulated and filtered. This prevents the unfiltered air outside the vehicle from entering the vehicle interior \Rightarrow .

Pressing  switches recirculation mode on or off manually.

Depending on vehicle equipment, automatic recirculation  controls the recirculation mode automatically when the function is switched on. You must press the  button if fog forms on the windows.

Seat heating

The seat heating temperature can be set at various levels. Press  once to switch on the highest level. Press  again to decrease the temperature



one level at a time. The seat heating is switched off if the button is not illuminated.

Depending on the vehicle equipment, you can adjust the seat temperature balance in the seat settings.

Applies to: surface heating: You can set whether surfaces are also heated when the seat heating is switched on \Rightarrow *page 101*.

Seat ventilation



Applies to: vehicles with seat ventilation

The seat ventilation intensity can be set to multiple levels. Press  once to switch on the highest level. Press  again to decrease the heat level one level at a time. The seat ventilation is switched off if the button is not illuminated.

Foot heating

Applies to: vehicles with a reclining seat system and foot heating

Fold out the leg support and, depending on the vehicle equipment, select the setting for the reclining seat in the Rear Seat Remote \Rightarrow *page 72*. You can now switch the foot heating on or off with .

The foot heating intensity can be set at multiple levels. Press  once to switch on the highest level. Press  again to decrease the heat level one level at a time. The foot heating is switched off if the button is not illuminated.

The foot heating will switch off automatically when the leg support is folded in.

Parental control

Applies to: vehicles with Rear Seat Remote

If  lights up in the Rear Seat Remote, the parental control is active and operation is blocked \Rightarrow *page 49*.

Ionizer

Applies to: vehicles with ionizer

Hazardous particles and germs in the air may be reduced through ionization. This helps to improve the air quality for individuals in the passenger compartment. 

Fragrance

Applies to: vehicles with fragrance function

The fragrance function will dispense a scent in the vehicle interior. It is dispensed through the front outer vents. This will produce a pleasant scent. The fragrance is time-delayed, especially at low or high temperatures. You can adjust the fragrance function ⇨ *page 101*.

Residual heat

The residual heat from the coolant is used to heat the vehicle interior. To use this function, press and hold the  button for more than two seconds while the ignition is switched off. The function will switch off automatically after approximately 15 minutes.

WARNING

- You should not leave the recirculation mode on for an extended period of time. This can cause the windows to fog, which increases the risk of an accident.
- Using recirculation mode or automatic recirculation for an extended period of time can cause the CO₂ concentration inside the vehicle to increase. This can have a negative effect on the well-being of vehicle occupants, which can increase the risk of an accident. Switch recirculation mode or automatic recirculation off and ventilate the vehicle at the first sign of unwellness.
- Individuals with reduced sensitivity to pain or temperature could develop burns when using the seat heating function. To reduce the risk of injury, these individuals should not use seat heating.

Note

To reduce the risk of damage to the seat heating elements, do not kneel on the seats or place heavy pressure on one area of the seat.

For the sake of the environment

Energy can be saved by switching off the A/C mode.

Tips

- If the front passenger's seat heating is turned on, it will not turn on again automatically if more than 10 minutes have passed between switching the ignition off and switching it on again.
- Applies to: vehicles with fragrance function: Only use the fragrance function in moderation and take any passengers and animals into consideration when using the function. An overlap of different scents or odors could cause discomfort. If there is discomfort, reduce the intensity or switch the fragrance function off. Only use fragrances that are approved by Audi.

Adjusting the vents

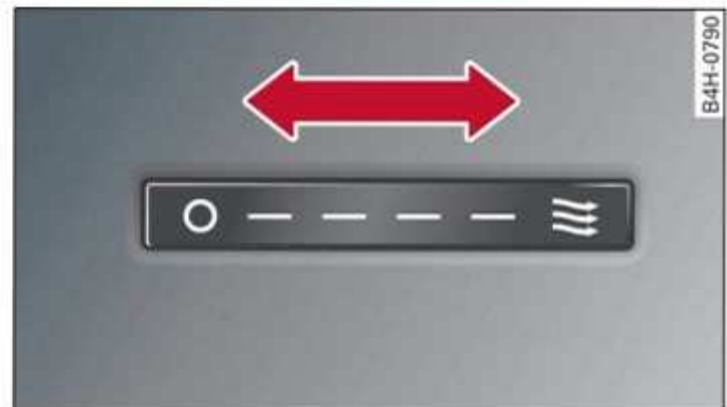

Fig. 85 Cockpit and rear center console: adjusting the air vents

You can open and close the air vents.

- ▶ Swipe right to open the air vents.
- ▶ Swipe left to close the air vents.

You can also press on the symbols directly to set the air supply at a certain level or turn it off.

The levers adjust the direction of the airflow from the vents.

Additional settings

You can adjust additional settings.

- ▶ Applies to: MMI: Select on the home screen: **VEHICLE > Air conditioning >**  ▶

Fragrance

Applies to: vehicles with fragrance function

Using **Fragrance selection**, you can select the fragrance and see the fill level of the fragrance.

You can select the strength of the scent with **Fragrance level**.

Footwell temperature

Applies to: vehicles with footwell heating

You can adjust the temperature for each front seat separately.

Surface heating

Applies to: vehicles with surface heating

When the seat heating is switched on, additional surfaces may also be heated. Other surfaces, such as the door armrest and the center armrest, may be heated, depending on the equipment.

Air quality indicator

Applies to: vehicles with air quality display

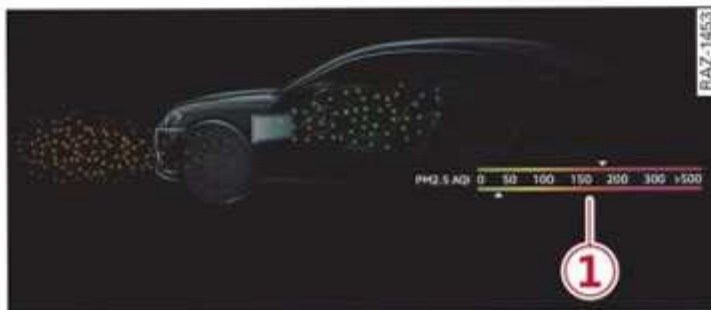

Fig. 86 Upper display: air quality indicator

You can display information about the air quality.

- ▶ Applies to: MMI: Select on the home screen: **VEHICLE > Air conditioning > Air quality**.
- ▶ Applies to: Rear Seat Remote: Press **AIR QUAL** on the home screen.

Active combination filter

Applies to: vehicles without particulate matter sensor

A schematic display represents the effectiveness of the filter. The display visualizes the amount of pollutant particles in the vehicle interior in comparison to the surroundings.

Particulate matter sensor

Applies to: vehicles with particulate matter sensor

A sensor detects the particulate matter concentration (PM2.5) outside and inside the vehicle. The detected values are displayed as the air qual-

ity index (AQI) on a colored scale ①. A value in the green range indicates very good air quality.

The system displays the approximate values, which may differ from actual conditions. In certain situations, no values or values that appear to be implausible may be displayed temporarily, or the system may only be available to a limited extent:

- in extreme weather conditions
- when the vehicle is stationary
- in a car wash
- if an individual smokes or if dust is stirred up in the vehicle interior
- if fresh air is introduced in order to prevent the windows from fogging

i Tips

- For optimal air quality in the vehicle interior, close all windows and doors and activate A/C cooling mode, the AUTO function, and recirculation mode.
- Applies to: vehicles with particulate matter sensor: The air quality display only shows the concentration of particulate matter (PM2.5). For technical reasons, the values measured in the vehicle may differ from the values measured by other measuring systems.

Steering wheel heating

Switching on and off

Applies to: vehicles with steering wheel heating







- ▶ Press  to switch steering wheel heating on or off.

You can also operate the steering wheel heating using the multifunction steering wheel
⇒ page 33.

Fluids in the A/C system

Refrigerant in the A/C system

The sticker in the engine compartment provides information about the type and amount of refrigerant used in the vehicle's A/C system. The sticker is located in the front section of the engine compartment or at the front or back of the hood.

Symbol	Meaning
	Warning: the A/C system must only be serviced by qualified technicians.
	Refrigerant type
	Lubricant type
	Refer to the service information (only available for authorized Audi dealers or authorized Audi Service Facilities)
	The A/C system must only be serviced by qualified technicians.
	Flammable refrigerant
	Make sure all components are disposed of correctly and never install components in the vehicle that have been removed from old vehicles or taken from recycling.

Lubricant in the A/C system

The sticker in the engine compartment provides information about the type and amount of refrigerant oil used in the vehicle's A/C system. For the refrigerant oil quantity, refer to the Technical Data ⇒ page 323.

 **WARNING**

The climate control system may only be serviced by qualified and certified technicians who have been trained according to the country-specific standards, for example SAE standards J2845 and J2911.

- The refrigerant is flammable. Keep the vehicle away from open flames, sparks, and other ignition sources to reduce the risk of serious or fatal injuries.

- The refrigerant is under pressure and can explode if heated, which increases the risk of serious or fatal injuries.
- The refrigerant can create toxic vapors when it comes in contact with hot surfaces. Do not breathe in these vapors, due to risk of serious or fatal injuries.

Tips

- Never repair the A/C system evaporator with components from old vehicles or from recycling.
- New replacement evaporators for portable A/C systems must be certified and labeled as such, so that they comply with the SAE standard J2842 HFO-1234yf and R744.

Driving

Starting the vehicle

Description



Fig. 87 Center console: starting the engine

Requirement: the key must be in the vehicle.

Starting the engine

- ▶ Press and hold the brake pedal.
- ▶ Press the **START ENGINE STOP** button. The engine will start.

Equipment that uses a lot of electricity is switched off temporarily when you start the engine. If the engine does not start immediately, the starting procedure stops automatically after a short time. If this is the case, repeat the starting procedure after approximately 30 seconds.

Stopping the engine

- ▶ Bring the vehicle to a full stop.
- ▶ Press the **START ENGINE STOP** button. The engine will switch off.

Applies to: vehicles with steering lock: The steering is locked when you turn off the engine with the selector lever in the "P" position and open the driver's door. The steering lock helps prevent vehicle theft.

Stopping the engine in an emergency

If necessary in an emergency, the engine can also be stopped while driving using the emergency off function*.

- ▶ Press the **START ENGINE STOP** button twice in a row or press and hold it one time.

Switching on and off

If you would like to switch the ignition on or off without starting the engine, follow these steps:

- ▶ Press the **START ENGINE STOP** button without pressing the brake pedal.

Switching the ignition off automatically

To prevent the vehicle battery from draining, the ignition and possibly the exterior lighting may switch off automatically.

Requirements:

- The Start/Stop system must have stopped the engine.
- You must have left the vehicle for longer than 30 seconds.
- The ignition must be switched on.

Among other indicators, the system detects that you have left the vehicle based on the following factors:

- The driver's door has been opened.
- The driver's safety belt has been unbuckled.
- The brake pedal is not being pressed.

The ignition will also be switched off after 30 minutes or if you lock the vehicle from the outside.

WARNING

- To reduce the risk of asphyxiation, never allow the engine to run in confined spaces.
- Never turn off the engine before the vehicle has come to a complete stop and the "P" selector lever position is engaged. Switching it off before the vehicle has stopped may impair the function of the brake booster and power steering. You would then need to use more force to steer and brake the vehicle. The fact that you cannot steer and brake as usual may increase the risk of accidents and serious injuries.
- Secure the vehicle against rolling before exiting the vehicle ⇒ *page 104*.

Note

- Avoid high engine speed, full throttle, and heavy engine load if the engine has not

reached operating temperature yet. You could damage the engine.

- If the engine has been under heavy load for an extended period of time, heat builds up in the engine compartment after the engine is switched off and there is a risk of damaging the engine. For this reason, let the engine run at idle for approximately two minutes before shutting it off.

i Tips

- Brief noises are normal when starting and parking the vehicle and are no cause for concern.
- For up to 10 minutes after stopping the engine, the radiator fan may turn on again automatically or it may continue to run, even if the ignition is switched off.
- It may not be possible to start the vehicle in extremely low temperatures.
- Power will be fully available once the engine is at operating temperature.

Messages

The following messages may appear depending on the vehicle equipment:

 **Engine start system: malfunction! Please contact Service**

Do **not** switch the ignition off because you may not be able to switch it on again. Drive to an authorized Audi dealer or authorized Audi Service Facility immediately to have the malfunction corrected.

 **Engine start system: malfunction! Please contact Service**

There is a malfunction in the engine start system. Drive immediately to an authorized Audi dealer or authorized Audi Service Facility to have the malfunction repaired.

 **Remote control key: key not detected. Is the key still in the vehicle?**

The vehicle key was removed from the vehicle while the engine is running. If the vehicle key is no longer in the vehicle, you cannot switch the ig-

nition on or start the engine once you stop it. You also cannot lock the vehicle from the outside.

 **Remote control key: hold back of key against the designated area. See owner's manual**

The battery in the vehicle key may be drained or there may be a malfunction. To start the vehicle, you must also hold the vehicle key against the location shown  ⇒ page 103, fig. 87.

If the malfunction remains, drive immediately to an authorized Audi dealer or authorized Audi Service Facility to have the malfunction corrected.

When driving

Starting to drive, stopping, and parking

Starting from a stop

- ▶ Press and hold the brake pedal.
- ▶ Start the engine.
- ▶ Select “D” or “R”.
- ▶ Release the parking brake.
- ▶ Release the brake pedal. The vehicle may roll.
- ▶ Press the accelerator pedal to accelerate.

Securing the vehicle against rolling

Secure your vehicle to prevent it from rolling before exiting the vehicle.

- ▶ Set the parking brake.
- ▶ Select the “P” selector lever position.
- ▶ If parking on a steep road, turn the steering wheel so that your vehicle will roll against the curb in case it should start to move.

If one of these measures is not possible, for example because there is no vehicle power, you must secure your vehicle against rolling using additional measures.

- ▶ Only park the vehicle on a level surface.
- ▶ Use suitable objects to block the front and rear wheels.

Set the parking brake before selecting the “P” selector lever position. This prevents too much stress from being put on the locking mechanism when parking on a steep surface. ▶

! WARNING

- Always set the parking brake when leaving your vehicle, even if for a short period of time. If the parking brake is not set, the vehicle could roll away, increasing the risk of an accident.
- Do not leave your vehicle unattended while the engine is running, because this increases the risk of an accident.
- If the parking brake is set, it can release automatically when the accelerator pedal is pressed. To reduce the risk of an accident, do not inadvertently press the accelerator pedal and always make sure the “P” selector lever position is selected when the vehicle is parked.
- If you leave the vehicle, switch the ignition off and take the key with you. This is especially important when leaving persons or animals in the vehicle. Otherwise, the vehicle could start unintentionally, the parking brake could release, or electronic equipment could activate, which increases the risk of an accident.
- No persons or animals should be left in a locked vehicle. Locked doors make it more difficult for emergency workers to enter the vehicle, which puts lives at risk.
- If you do not begin driving immediately after releasing the brake pedal, your vehicle may begin to roll backward. Press the brake pedal or set the parking brake immediately.

! Note

If you have to stop on an incline, always press the brake pedal to hold the vehicle in place to reduce the risk of the vehicle rolling backward. Do not try to hold the vehicle in place by pressing and holding the accelerator pedal. The transmission can overheat, which increases the risk of damage.

Hill hold assist

If you take your foot off of the brake pedal when driving on hills, the braking force will be held for

several seconds. At that time, you can start driving without the vehicle rolling backward.

Requirement: the driver's door must be closed, the engine must be on, and the vehicle must be traveling uphill.

- ▶ To activate hill hold assist, press and hold the brake pedal for several seconds while the vehicle is stationary.

! WARNING

- If you do not begin driving immediately after releasing the brake pedal, your vehicle may begin to roll backward. Press the brake pedal or set the parking brake immediately.
- The hill hold assist cannot hold the vehicle on inclines in every scenario (for example, on slippery or icy ground).

Gears and driving programs

Fig. 88 Center console: selector lever

The automatic transmission shifts automatically depending on the selected gear and the current driving style. When driving with a moderate driving style, upshifting early and downshifting late will help to improve fuel economy. When driving with a sporty driving style, the transmission permits higher RPMs.

Gears

The gears are displayed next to the selector lever.

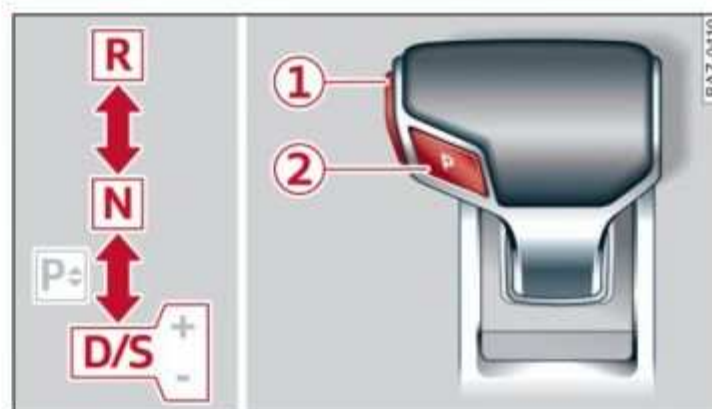
- P (Park): parking lock
- R (Reverse): driving in reverse
- N (Neutral): idle
- D (Drive): driving forward

Driving programs

Various driving programs can be selected when in the “D” position. These programs influence, for example, when the transmission shifts and how the accelerator pedal responds.

The selected driving program is displayed in the instrument cluster.

- **D** (Drive): normal driving mode
- **S** (Sport): sporty driving mode

Selecting a gear

Requirement: the ignition must be switched on.

- Bring the vehicle to a full stop and press the brake pedal.
- Press the release button ① on the selector lever.
- To select the nearest position, move the selector lever forward or back until you feel the first pressure point.
- To skip a position (for example, to move from “D” directly to “R”), move the selector lever past the pressure point in the desired direction.
- The label next to the selector lever for the selected gear will light up.

“N” (Neutral) selector lever position

In the “N” selector lever position, power is not transmitted to the driving wheels. Use the “N” selector lever in a car wash (with conveyor belts), for example.

If you unintentionally select “N” while driving (faster than 1 mph (2 km/h)), you can select “D” again without pressing the brake pedal.

For safety reasons, the vehicle cannot be locked when the “N” position is engaged.

“P” (Park) selector lever position

Requirement: the ignition must be switched on.

The parking lock secures the vehicle from rolling when the “P” selector lever position is selected. The parking lock is a mechanical locking mechanism in the transmission.

- Bring the vehicle to a full stop and press the brake pedal.
- Press the “P” button ② on the selector lever.

– The “P” next to the selector lever will light up.

“P” engages automatically if you switch the engine off while the “D” or “R” gear is selected. If you switch the engine off in “N”, “P” will engage automatically after approximately 30 minutes.

If you want to switch to another gear from “P”, the engine must be running.

If you cannot shift out of “P”, for example because the vehicle has no power, you may need to use the manual release for the parking lock ⇒ *page 108*.

Selecting the driving program

To switch between the current driving program and “S”, push the selector lever toward the rear.

If you select the **dynamic** mode in Audi drive select*, the “S” driving program will be activated. When the ignition is switched off, the driving program may be reset to “D”.

WARNING

- Before you start driving, check if the label for the desired selector lever position next to the selector lever is lit up.
- Secure the vehicle against rolling before exiting the vehicle ⇒ *page 104*.
- Power is still transmitted to the wheels when the engine is running at idle. To prevent the vehicle from “creeping”, you must keep your foot on the brake in all selector lever positions (except “P” and “N”) when the engine is running.
- To reduce the risk of an accident, do not press the accelerator pedal when changing gears if the vehicle is stationary and the engine is running.
- Never select the “R” position while driving. Doing so could cause an accident.
- The vehicle can roll even if the ignition is switched off.

Tips

- If you shift back and forth between “D” and “R” within one second, you do not need to press the brake pedal. This makes it possible to “rock” if it is stuck, for example. ▶

– Audi recommends the “D” driving program for everyday driving.

Manual shifting



Fig. 89 Center console: shifting manually with the selector lever



Fig. 90 Steering wheel: shift paddles*

You can shift the gears manually when in “D” mode. The transmission must be in tiptronic mode.

Shifting with the selector lever

You can shift into manual shifting mode while the vehicle is stationary or while driving.

- ▶ To switch to manual shifting mode, tilt the selector lever toward the front passenger's side ⇒ *fig. 89*. “M” will be displayed in the instrument cluster.
- ▶ Upshifting: push the selector lever forward (+).
- ▶ Downshifting: push the selector lever toward the rear (-).
- ▶ To switch back to automatic mode, tilt the selector lever toward the driver's side.

Shifting with the shift paddles

Applies to: vehicles with shift paddles

- ▶ Upshifting: press the (+) shift paddle ⇒ *fig. 90*.
- ▶ Downshifting: press the (-) shift paddle.

- ▶ To engage the lowest possible gear for maximum acceleration, press and hold the (-) shift paddle.
- ▶ To switch back to automatic mode, press and hold the (+) shift paddle or push the selector lever toward the rear.

If you stop using the shift paddles temporarily, the transmission will switch back to automatic mode. To keep shifting manually, tilt the selector lever toward the front passenger's side.

i Tips

- The transmission only allows manual shifting when the engine speed is within the permitted range.
- The transmission automatically shifts up or down before critical engine speed is reached.

Accelerator pedal

You can accelerate the vehicle using the accelerator pedal.

Maximum acceleration

If you press the accelerator pedal all the way down, the motor's full power will be used and you will reach maximum acceleration, also called “kick-down”.

! WARNING

The driving wheels could spin and the vehicle could swerve on slick or slippery road surfaces when using kick-down, which increases the risk of an accident.

Parking lock emergency release



Fig. 91 Footwell: releasing the parking lock using the emergency release

The manual release is located under the floor mat on the driver's side. Read and follow the important instructions about towing ⇒ *page 306*.

Releasing the parking lock using the manual release

- ▶ Secure the vehicle against rolling ⇒ *page 104*.
- ▶ Pry the cover off at one of the openings using the screwdriver from the vehicle tool kit ⇒ *page 300*.
- ▶ Insert the socket wrench from the vehicle tool kit into the opening.
- ▶ Turn the socket wrench clockwise ① until it stops and press it downward ② until it locks into place.
- ▶ Leave the socket wrench inserted.

Resetting the parking lock

- ▶ Grasp the socket wrench with both hands and carefully pull it upward to remove.
- ▶ Install the cover.

⚠ WARNING

- The parking lock must be released using the emergency release before towing the vehicle.
- Only use the parking lock manual release if the vehicle is secured against rolling ⇒ *page 104*. An unsecured vehicle may roll, which increases the risk of an accident.
- Only activate the manual release while on a level surface or a slight slope.

– To reduce the risk of an accident, you must not drive when the manual release is activated.

Messages

The following messages may appear depending on the vehicle equipment:

⚠ Transmission: malfunction! Safely stop vehicle

Do not continue driving. Stop the vehicle as soon as possible in a safe location and secure it so it does not roll ⇒ *page 104*. See an authorized Audi dealer or authorized Audi Service Facility for assistance.

⚠ Transmission: too hot. Please stop vehicle

Do not continue driving. Secure the vehicle against rolling ⇒ *page 104*. See an authorized Audi dealer or authorized Audi Service Facility for assistance.

⚠ Transmission: too hot. Please adapt driving style

The transmission temperature has increased significantly. Drive very cautiously or take a break from driving until the temperature returns to the normal range and the indicator light turns off.

⚠ Transmission: malfunction! You can continue driving. See owner's manual

There is a system malfunction in the transmission. You may continue driving. Drive to an authorized Audi dealer or authorized Audi Service Facility soon to have the malfunction corrected.

⚠ Transmission: malfunction! You can continue driving with limited function. Please contact Service

There is a system malfunction in the transmission. The transmission is switching to emergency mode. This mode only shifts into certain gears or may no longer shift at all. The engine may stall. Drive to an authorized Audi dealer or authorized Audi Service Facility immediately to have the malfunction corrected.

Transmission: malfunction! You can continue driving with limited function. No reverse gear

There is a system malfunction in the transmission. The transmission is switching to emergency mode. This mode only shifts into certain gears or may no longer shift at all. The engine may stall. You cannot engage the reverse gear. Drive to an authorized Audi dealer or authorized Audi Service Facility immediately to have the malfunction corrected.

Transmission: malfunction! You can continue driving in D until engine is off

There is a system malfunction in the transmission. The transmission is switching to emergency mode. If you turn the engine off, you will not be able to select any other gears after restarting the engine. Drive to an authorized Audi dealer or authorized Audi Service Facility immediately to have the malfunction corrected.

Selector lever: malfunction! You can continue driving. Please contact Service

There is a system malfunction in the selector lever. Drive immediately to an authorized Audi dealer or authorized Audi Service Facility to have the malfunction repaired.

Selector lever: malfunction! Gear change only possible if using both shift paddles.

There is a system malfunction in the selector lever. You can continue driving with restricted function. The selector lever is not working. Gears can only be selected by tapping both shift paddles at the same time when the vehicle is stationary. The "P" gear is automatically engaged when you turn off the engine. Drive to an authorized Audi dealer or authorized Audi Service Facility immediately to have the malfunction corrected.

P button: malfunction! Auto P when engine off. Please contact Service

There is a malfunction in the "P" button on the selector lever. The "P" gear is automatically engaged when you turn off the engine. Drive to an authorized Audi dealer or authorized Audi Service

Facility immediately to have the malfunction corrected.

Danger of rolling away! P not possible. Please apply parking brake

- The parking lock was released using the manual release ⇒ *page 108*. Or:
- The parking lock can no longer be engaged. Drive to an authorized Audi dealer or authorized Audi Service Facility immediately to have the malfunction corrected. Secure the vehicle against rolling before exiting the vehicle ⇒ *page 104*.

Move selector lever to automatic position

The transmission has switched out of tiptronic mode. Switch back to automatic mode with the selector lever ⇒ *page 107*.

Drive system

Breaking in

A new vehicle must be broken in within the first 1,000 miles (1,500 km) so that all moving parts work smoothly together, which helps to increase the service life of the engine and other drive components.

Do not drive higher than two-thirds of the maximum permitted engine RPM during the first 600 miles (1,000 km) and do not use full acceleration. The engine can be increased RPM gradually during the next 300 miles (500 km).

Conventional and mild hybrid drive system

Applies to: vehicles with a conventional drive system or a mild hybrid drive system

Vehicles with a conventional or mild hybrid drive system are powered by a combustion engine. It uses fuel to recover energy.

Vehicles with a mild hybrid drive system have additional battery technology.

Efficient and environmentally-friendly driving

Your driving style greatly influences the amount of fuel and energy consumed, the environmental ►

impact, and the wear on the motor, brakes, and tires. Note the following information for efficient and environmentally-conscious driving:

- Turn off electrical equipment that is not needed, for example seat heating*.
- Anticipate upcoming traffic situations while driving to avoid unnecessary acceleration and braking.
- Avoid driving at high speeds.
- Avoid adding extra weight to the vehicle if possible, for example by not leaving roof racks or bike racks installed when they are not needed.
- Make sure the tire pressure is correct.
- Have maintenance performed regularly on the vehicle.
- Do not let the engine run while the vehicle parked.
- Do not drive with winter tires during the summer.
- Use the Start/Stop system.
- Utilize the engine braking effect.
- Avoid driving short distances when possible.

Tips

The amount of noise produced by the vehicle can increase significantly when driving with a sporty style. Show respect to others around you and the environment with the way you operate your vehicle, especially at night.

Energy management

Your vehicle is equipped with an intelligent energy management system for distributing electricity. This significantly improves the starting ability and increases the vehicle battery life.

Tips

- If you drive short distances frequently, the vehicle battery may not charge enough while driving. As a result, convenience functions for electrical equipment may be temporarily unavailable.
- The vehicle battery will gradually drain if the vehicle is not driven for long periods of time, or if electrical equipment is used when the engine is not running. To ensure

that the vehicle can still be started, the electrical equipment will be limited or switched off.

Messages

The following messages may appear depending on the vehicle equipment:

Drive system: malfunction! Safely stop vehicle

There is a malfunction in the drive system. The brake booster and the power steering may stop working. Stop the vehicle immediately or as soon as possible and do not continue driving. Secure the vehicle against rolling before exiting the vehicle ⇒ *page 104*. Have the problem corrected by an authorized Audi dealer or authorized Audi Service Facility.

Drive system: malfunction! Please contact Service

There is a malfunction in the drive system. Drive slowly to an authorized Audi dealer or authorized Audi Service Facility to have the malfunction corrected.

Start/Stop system

Description

Applies to: vehicles with Start/Stop system

The Start/Stop system can help increase fuel economy and reduce CO₂ emissions. In Start/Stop mode, the engine shuts off automatically when stopped, for example at a traffic light.

If certain conditions are met, the engine may stop before the vehicle has come to a complete stop. If you press the accelerator pedal when this happens, the engine will start and driving power will be transmitted.

The ignition and important assist systems such as the brake booster will remain available during the Stop phase. The engine will restart automatically when needed.

The Start/Stop system is automatically activated once the ignition is switched on. ▶

Switching the Start/Stop system off and on

The  button is located above the selector lever in the center console. The button will be illuminated when the function is switched off.

- ▶ Press  to switch the system on or off.

If you switch the system off during a Stop phase, the engine will start again automatically.

Basic requirements

- The driver's door and hood must be closed.
- "P", "N", or "D" must be engaged.
- The steering wheel must not be turned far in either direction.
- The vehicle must have driven faster than 2 mph (3 km/h) since the last time it stopped.
- The vehicle is not in trailer mode.

Note

Always switch the Start/Stop system off when driving through water ⇒ *page 111*.

Tips

- Depending on the driving situation, the engine may already stop when **coasting** before the vehicle has come to a complete stop.
- If you select the "D" position after shifting into reverse, the vehicle must be driven faster than 6 mph (10 km/h) in order for the Start/Stop system to become active again. This makes it possible to maneuver without stopping the engine.

Stopping and starting the engine

Applies to: vehicles with Start/Stop system

- ▶ Press and hold the brake pedal until the vehicle has stopped. The  indicator light appears in the instrument cluster once the engine stops automatically.
- ▶ The engine starts again when you remove your foot from the brake pedal. The indicator light turns off.

If the parking brake is set, the engine will only start again when the accelerator pedal is pressed.

Tips

- Press the brake pedal during a Stop phase to keep the vehicle from rolling.
- The ignition will turn off if you press the **START ENGINE STOP** button during a Stop phase.
- If you leave the vehicle briefly during a Stop phase and then enter again, the driver's door must be closed and the safety belt must be fastened in order for the engine to be able to restart.
- You can control if the engine will stop or not by reducing or increasing the amount of force you use to press the brake pedal. For example, if you only lightly press on the brake pedal in stop-and-go traffic or when turning, the engine will not switch off when the vehicle is stationary. If you press the brake pedal harder, the engine will switch off.

Starting and stopping the engine automatically

Applies to: vehicles with Start/Stop system

The system checks if certain conditions are met before and during the Stop phase, and determines if the engine stops and how long it remains stopped. For example, if power usage is high, the engine will not be stopped. Along with other conditions, the following factors influence the automatic engine start or stop:

- Environmental conditions (slopes, inclines, elevation, temperature)
- Battery (charge status, temperature, power usage)
- Engine temperature
- Assist systems
- Driving behavior

Depending on the engine, the  indicator light may appear if the engine is not stopped.

Messages

Applies to: vehicles with Start/Stop system

The following messages may appear depending on the vehicle equipment: ▶

Drive system: please start the vehicle manually

This message appears when specific conditions are not met during a Stop phase. The Start/Stop system will not be able to restart the engine. The engine must be started with the **START ENGINE STOP** button.

Vehicle starting system: malfunction! Please contact Service

There is a malfunction in the Start/Stop system. Drive the vehicle to an authorized Audi dealer or authorized Service Facility as soon as possible to have the malfunction corrected.

Brakes

General information

You can apply the vehicle's brakes using the brake pedal.

Operating noise

Noises may occur when braking depending on the speed, braking force, and outside conditions such as temperature and humidity.

Braking effect

The response time from the brakes depends on the weather and environmental conditions. To ensure the optimal braking effect, the brake system is cleaned at regular intervals. This is done by applying the brake pads to the brake rotors for a short period of time when driving at high speeds when the windshield wipers are switched on.

If the brake system becomes damp, for example after driving in heavy rain, the braking effect may be delayed. Other factors that could temporarily increase the response time of the brakes include:

- Wet conditions
- Low temperatures, ice, and snow
- Roads covered in salt
- Dirty brake pads

Corrosion

Corrosion may form on the brake rotors if there is no heavy braking, if the vehicle is not driven for long periods of time, or if the vehicle is not driv-

en frequently or for long distances. In this case, braking heavily several times while driving at high speeds can clean the brake rotors ⇨ ⚠.

Brake pads

New brake pads do not achieve their full braking effect during the first 250 miles (400 km). They must be "broken in" first. However, you can compensate for the slightly reduced braking force by pressing firmly on the brake pedal. Avoid heavy braking during the break-in period.

Brake pad wear depends largely on the way the vehicle is driven and on operating conditions. Brake pad wear increases when driving frequently in the city or short distances or when using a very sporty driving style.

Ceramic brakes

Applies to: vehicles with ceramic brakes

Ceramic brakes provide excellent deceleration rates.

The break-in period for new ceramic brakes may be significantly longer than for standard brake rotors. The properties of the material may also cause noise, especially when driving at lower speeds. Ceramic brakes also absorb more moisture in wet conditions. Therefore, there will temporarily be less braking force than when the brakes are dry. You can compensate for this by pressing the brake pedal harder.

Automatic post-collision braking system

The automatic post-collision braking system can help to reduce the risk of sliding and of additional collisions after an accident. If the airbag control module detects a collision, the vehicle is braked by the ESC.

The vehicle does not brake automatically if one of the following occurs:

- You are pressing the accelerator pedal, or
- The braking force generated by the pressed brake pedal is greater than the braking force that would be initiated by the system
- The ESC, the brake system, or the vehicle electrical system is not functioning

! WARNING

- Only apply the brakes for the purpose of cleaning the brake system when road and traffic conditions permit. You must not endanger other road users because this increases the risk of an accident.
- Due to the risk of injury, only have an authorized Audi dealer or authorized Audi Service Facility work on the brake system. Incorrect repairs could impair the function.
- Never let the vehicle roll while the engine is stopped because this increases the risk of an accident.
- During automatic braking maneuvers, the brake pedal may move downward automatically. To reduce the risk of injury, do not place your foot under the brake pedal.

! Note

- Never let the brakes “rub” by pressing the pedal lightly when braking is not actually necessary. This can cause the brakes to overheat and increases braking distance and causes wear.
- Observe the important information for driving downhill ⇒ *page 115*. This especially applies when towing a trailer.

i Tips

- If you retrofit your vehicle with a front spoiler, wheel covers or similar items, make sure that the air flow to the brakes is not obstructed. Otherwise the brake system can overheat.
- Also refer to the information about brake fluid ⇒ *page 262*.

Messages

The following messages may appear depending on the vehicle equipment:

BRAKE / ! Brakes: malfunction! Safely stop vehicle

There is a malfunction in the brake system. If **ABS / !** and **!** also turn on, there is a malfunction in the ABS, ESC, and braking distribution. If

the brake booster is not working, you have to use much more force when braking the vehicle.

Do not continue driving. See an authorized Audi dealer or authorized Audi Service Facility for assistance. Read and follow the other safety precautions ⇒ **!**.

BRAKE / ! Brake pads: wear limit reached. You can continue driving. Please contact Service

The brake pads are worn. Drive to an authorized Audi dealer or authorized Audi Service Facility as soon as possible to have the malfunction corrected.

Brake booster: limited functionality. You can continue driving. Please contact Service

There is a brake booster malfunction. The brake booster is available, but its effectiveness is reduced. The braking performance may be different compared to the usual performance. Drive to an authorized Audi dealer or authorized Audi Service Facility immediately to have the malfunction corrected.

Brake booster: deactivated. See owner's manual

The brake booster remains active for a brief period of time after switching off the ignition. Secure the vehicle against rolling ⇒ *page 104*.

Other indicator lights

When you switch the ignition on, the **BRAKE / !** indicator light turns on briefly to check the function. If the indicator light does not turn on, there is a system malfunction.

If **BRAKE / !** stays on, there is a malfunction in the brake system.

! – A high load was placed on the brakes from driving downhill for a long period of time. Follow the instructions in the message to utilize the engine braking effect and to relieve the brakes.

! WARNING

If a malfunction occurs in the ABS, ESC, and braking distribution, interventions that stabilize the vehicle will no longer be available. This could cause the vehicle to swerve, which increases the risk that the vehicle will slide.

Do not continue driving. See an authorized Audi dealer or authorized Audi Service Facility for assistance.



Electromechanical parking brake

Operating the parking brake

The electromechanical parking brake is used to secure the vehicle from rolling away unintentionally.

The  switch is located under the selector lever in the center console. It turns on when the parking brake is set. You can release the parking brake manually or automatically when you start to drive.

Setting and releasing the parking brake

- ▶ Setting: pull the  switch.
- ▶ If **PARK** /  appears, the parking brake is holding the vehicle. You can remove your foot from the brake pedal.
- ▶ Releasing: when the ignition is switched on, press and hold the brake pedal and press the  button.

If the red indicator light flashes, the braking force has not built up enough or it has decreased. You can also secure the vehicle by selecting the "P" gear or pressing the brake pedal. Make sure the indicator light is off before you start driving.

Automatically releasing the parking brake when starting to drive

Requirement: the driver's door must be closed and the driver safety belt must be fastened.

- ▶ Press the accelerator pedal to start to drive.

WARNING

- To reduce the risk of an accident, always make sure the vehicle is situated safely while stationary.
- If the parking brake is set, it can release automatically when the accelerator pedal is pressed. To reduce the risk of an accident, do not inadvertently press the accelerator

pedal and always shift into "P" when the vehicle is stopped.

- If the power supply fails, you cannot set the parking brake once it is released, or release it if it is set. Secure the vehicle against rolling before exiting the vehicle ⇒ *page 104*. See an authorized Audi dealer or authorized Audi Service Facility for assistance.

Tips

- On steep inclines, especially when in trailer mode, the vehicle may roll backwards unintentionally when starting to drive. To reduce the risk of this happening, pull and hold the  switch while pressing the accelerator pedal. If enough drive power has built up at the wheels and the vehicle does not roll backwards, then release the switch to start to drive.
- If you leave the vehicle when "D" or "R" are engaged, the parking brake will be set automatically.
- Noises when the parking brake is set and released are normal and are not a cause for concern.
- The parking brake goes through a self-test cycle at regular intervals when the vehicle is stopped. Any noises associated with this are normal.

Emergency braking function

Emergency braking should only be used in an emergency, if the standard brake pedal is malfunctioning or obstructed. When the emergency braking function is activated, the braking effect is similar to a heavy braking maneuver.

- ▶ Pull and hold the  switch while driving.
- ▶ An audio warning signal will sound and emergency braking will begin.
- ▶ If you press the accelerator pedal, emergency braking will be canceled.

WARNING

Heavy braking while driving through curves or in poor road or weather conditions can cause the vehicle to slide or the rear of the vehicle

to swerve, which increases the risk of an accident.

Messages

The following messages may appear depending on the vehicle equipment:

BRAKE /  **Parking brake: malfunction! Safely stop vehicle. See owner's manual**

BRAKE /  **Parking brake: malfunction! Please release parking brake**

If one of the two messages appears, there is a malfunction in the parking brake. If the message appears while stationary, check if the parking brake is released and can be reset. If this is the case, switch the ignition off and back on.

If the message stays on, if the parking brake cannot be released, or if the message appears while driving, do not continue driving. Secure the vehicle against rolling before exiting the vehicle ⇒ *page 104*. See an authorized Audi dealer or authorized Audi Service Facility for assistance.

 **Parking brake: malfunction! Please contact Service**

There is a malfunction in the parking brake. Drive to an authorized Audi dealer or authorized Audi Service Facility immediately to have the malfunction corrected. Do not park the vehicle on inclines and shift to "P".

HAZ /  **Parking brake: warning! Vehicle position too steep**

The braking force may not be enough to secure the vehicle from rolling away. Park the vehicle in a place with less of an incline.

HAZ /  **Parking brake: applied**

The parking brake is set. Press and hold the brake pedal to release the parking brake.

Special driving situations

Driving uphill and downhill

When driving uphill, downhill, or at high altitudes, note the following information:

- Drive slowly and carefully.
- Do not try to turn around if you cannot safely drive on an incline or hill. Instead, drive in reverse.
- When driving down hills, you can activate the hill descent control if you press the brake pedal while driving in "D" gear. The automatic transmission will select a gear suitable for driving down the hill and will attempt to maintain the speed at which the vehicle was traveling at the time the brake pedal was pressed. Press the brake pedal if necessary. The hill descent control will switch off once the hill levels out or you press the accelerator pedal.
- Utilize the engine braking effect when driving downhill by selecting the "S" driving program ⇒ *page 106*. This especially applies when towing a trailer. This reduces the load on the brakes.
- Apply the brakes in intervals and do not press the brake pedal continuously.

WARNING

- Only drive on inclines that your vehicle is designed to handle. Do not exceed the hill climbing ability of your vehicle. Your vehicle could tip or slide.
- Do not drive at an angle on steep inclines and hills. If your vehicle is about to tip, you must immediately start steering in the direction of the downward slope to reduce the risk of an accident.
- Always be ready to brake when using the hill descent control function.

Driving through water

If you must drive through water, follow these instructions:

- Check the stability of the ground, the current, and the water depth. If the ground is unstable, there is a strong current, or there are waves, the water must only reach **up to the lower edge of the body at the most**.
- Deactivate the Start/Stop system.
- Drive carefully and no faster than at walking speeds to prevent the front of the vehicle from creating waves, because they could splash ▶

above the lower edge of the body. Oncoming vehicles could also create waves.

- Do not stop the vehicle while in the water.
- Do not drive in reverse.
- Do not turn the engine off.

WARNING

After driving through water, press the brake pedal carefully to dry the brakes so that the full braking effect will be restored.

Note

Vehicle components such as the motor, drive system, suspension, or electrical system can be severely damaged by driving through water.

Tips

If possible, avoid driving through salt water because it increases the risk of corrosion. Use fresh water to clean any vehicle components that come into contact with salt water.

Driving dynamic

Audi drive select

Introduction

Applies to: vehicles with Audi drive select

Drive select makes it possible to experience different types of vehicle characteristics in one vehicle. With different driving modes, the driver can change the setting, for example from sporty to comfortable. This allows you to adjust individual systems collectively as a group to your personal preferences.

Selecting an Audi drive select mode

Applies to: vehicles with Audi drive select

The **drive select** button is located above the selector lever in the center console.

- ▶ Press the left or right arrow key until the desired mode appears in the MMI. Or:
- ▶ Applies to MMI: Select on the home screen: **VEHICLE > Audi drive select**.

You can change the driving mode when the vehicle is stationary or while driving. If traffic permits, briefly remove your foot from the accelerator pedal after changing modes so that the mode you have selected will be activated for the drive system.

The following modes may be available depending on the equipment:

comfort – Provides a comfort-oriented vehicle setup and is suited for long drives on highways.

comfort+ – Provides a comfort-oriented vehicle setup and switches on the curve tilting function in the active suspension system. This mode is suitable for long trips on highways and smooth driving around curves, for example.

auto – Provides an overall comfortable yet dynamic driving feel.

dynamic – Provides a sporty driving feel and is suited to a sporty driving style. The “S” driving program is selected.

Individual – Provides the option for personalized vehicle settings. Press  to configure the mode
⇒ page 117, *Individual settings*.

Tips

- When the ignition is being switched on, individual systems, such as the drive system, will be reset to a balanced setting. Select the current mode again to attain its full configuration.
- Audi recommends the **auto** mode for everyday driving.

Individual settings

Applies to: vehicles with Audi drive select

The equipment in your vehicle will determine which settings you can adjust.

Drive

The drive system will react to accelerator pedal movement more quickly or in a more balanced manner. The shift points are placed in higher or lower speed ranges.

Depending on the setting, the drive power at the rear axle will be distributed with the sport differential* to be more sporty or moderate
⇒ page 121.

Steering

The power steering will adapt. Light steering is suitable for long trips on highways or smooth driving around curves, for example.

Suspension

The suspension adjusts to be tighter or more comfort-oriented when it comes to compensating for uneven spots on the road.

Based on the selected setting, the air suspension* will adjust the ground clearance and the active suspension* will provide various degrees of compensation for vehicle movements.

Engine sound

The engine sound adapts and can be subtle to sporty. In the automatic setting, the engine sound depends on the selected driving program.

Suspension

Air suspension

Applies to: vehicles with air suspension

The air suspension is an electronically-controlled suspension and leveling system. The firmness of the suspension will adapt to the driving conditions and the driving situation. The system balances out changes in load. The vehicle level will also adapt gradually to the vehicle speed in order to reduce the wind resistance at high speeds and increase the ground clearance at low speeds. The settings depend on the selected Audi drive select* mode.

Displaying the vehicle level

- ▶ Applies to MMI: Select on the home screen: **VEHICLE > Audi drive select**.

The filled-in boxes represent the current vehicle level. The more boxes that are filled in, the higher the ground clearance. The box that corresponds with the current vehicle level will flash while the vehicle is lifting or lowering. The target level is highlighted in color.

Raising the vehicle

- ▶ Applies to MMI: Select on the home screen: **VEHICLE > Audi drive select**.
- ▶ Press **Raise** to reach the highest vehicle level and thus the maximum ground clearance.
- ▶ Press **Lower** to lower the vehicle down again.

The vehicle will lower at speeds of approximately 22 mph (35 km/h) and below. This function may only be used temporarily when increased ground clearance is necessary. It is not intended for long drives.

Note

- Also refer to the information about ground clearance ⇒ *page 119*.
- When transporting the vehicle on a road carrier, rail carrier, ship carrier, or other carrier, it may only be secured at the running surfaces of the tires (circumference). Securing the vehicle at the axle components, suspension struts, or towing eyes is not permitted because the pressure in the air suspen-

sion struts can change during transport. The vehicle might not be secured sufficiently if this happens.

Active suspension

Applies to: vehicles with active suspension

The active suspension enhances the air suspension with an electromechanically-controlled suspension system. It selectively influences rolling movements when driving around curves and pitching movements, for example when braking and accelerating. It also reduces lifting movements when driving over bumps. The settings depend on the selected Audi drive select* mode.

The curve tilting function is also switched on in the **comfort+** Audi drive select* mode. This function reduces the force on the vehicle occupants when driving around curves by tilting the vehicle toward the inside of the curve.

Display

You can display the principal functions of the active suspension.

- ▶ Applies to: MMI: Select on the home screen: **VEHICLE > Vehicle data**.
- ▶ You may need to scroll down to the **Active suspension** display.

It will display how the vehicle body movements are compensated at each wheel. The more the cylinder is filled in, the more the system is intervening. Please note that the display here is not to scale.

Settings

- ▶ Open the active suspension display and select .

With **Predictive scanning: unevenness detection**, you can adjust how much the vehicle will compensate for bumps in the road. For this purpose, there is a camera behind the windshield that detects the road conditions and activates the active suspension when bumps are predicted. A colored visual beam in the display indicates when this function is activated. This function may only have limited availability under certain conditions, for example, when it is dark ⇒ *page 128*. ▶

Applies to: vehicles with elevated entry

With the **Elevated entry** function, you can select if the vehicle should be raised when a door is opened in order to enter and exit the vehicle more comfortably. The vehicle will lower again slowly in the following situations:

- When starting from a stop
- When locking the vehicle
- When changing the Audi drive select* mode
- Approximately 10 seconds after all doors have been closed
- After a certain period of time when the engine is stopped and a door is open, in order to maintain the battery charge level.

This function may not be available under certain conditions, for example if the ground is not level or when the battery charge level is low. The function may also be deactivated temporarily after the vehicle is serviced using diagnostic equipment, and it will only be available again once the vehicle is driven a certain distance.

Note

When the elevated entry function is activated, make sure there is sufficient space above and below the vehicle. This particularly applies to space under open doors and above roof structures. If you are unsure about the amount of space, deactivate the elevated entry function before exiting the vehicle to reduce the risk of damage.

Tips

- If an open door touches the ground or becomes stuck, use the **Raise** ⇨ *page 118* function in the MMI to raise the vehicle using the air suspension.
- When the curve tilting function is switched on, the vehicle occupants will experience less turning force while driving around curves. This may influence the perception of speed. Always adjust the speed to the driving situation.

Ground clearance

The vehicle height and clearance can be influenced by the following factors:

- Change in temperature
- Change in load
- Change to the Audi drive select* mode
- Lifting and lowering via the air suspension*
- Automatic lifting and lowering using the Elevated entry* function

WARNING

To reduce the risk of injury, make sure no one gets pinched when the vehicle level is changing, for example when cleaning the underbody or the wheel housings.

Note

Always make sure there is enough clearance above and below the vehicle. This is especially important for entrances with height restrictions, for example, before driving into underground garages. You could also scrape the ground when driving over the edges of curbs or on steep ramps, which could damage your vehicle.

Messages

The following messages may appear depending on the vehicle equipment:

 **Air suspension: malfunction! You may continue driving slowly at max. XXX mph (km/h)**

There is a malfunction. Driving stability may be limited. Drive to an authorized Audi dealer or authorized Audi Service Facility immediately. Do not drive faster than the speed given in the message.

 **Air suspension: malfunction! Safely stop vehicle. Steering and ground clearance limited**

There is a malfunction. Do not continue driving. Secure the vehicle against rolling before exiting the vehicle ⇨ *page 104*. Avoid turning the steering wheel, because the vehicle ground clearance may be so low that turning the steering wheel could result in damage to the wheels and wheel housings. ▶

 **Active suspension: unavailable. Limited stability. Can continue driving with caution. See owner's manual**

There is a heavy load on the vehicle electrical system or the active suspension. Therefore, the active suspension functions will be temporarily switched off. Driving stability is reduced. Continue driving with caution.

 **Active suspension: malfunction! Limited stability. You can continue driving with caution**

There is a malfunction. Driving stability is reduced. See an authorized Audi dealer or authorized Audi Service Facility for assistance.

 **Air suspension: vehicle too low. Limited ground clearance**

The vehicle ground clearance is very low. Wait until the air suspension system has restored normal ground clearance. Have an authorized Audi dealer or authorized Audi Service Facility repair the malfunction immediately if the indicator light does not turn off after a significant period of time.

 **Air suspension: malfunction! Please contact Service**

There is a malfunction. The driving stability may be limited and the ground clearance may be low. See an authorized Audi dealer or authorized Audi Service Facility for assistance.

 **Active suspension: currently limited. See owner's manual**

There is a heavy load on the vehicle electrical system or the active suspension. Therefore, the active suspension functions are temporarily limited.

 **Active suspension: predictive scanning unavailable. See owner's manual**

There is a malfunction. The camera's visual field may be blocked. Clean the windshield. If the malfunction continues, drive to an authorized Audi dealer or authorized Audi Service Facility immediately.

Steering

Description

Electromechanical steering supports steering movements by electronically adapting the power steering depending on the vehicle speed. The settings depend on the selected Audi drive select* mode.

Dynamic all-wheel steering

Applies to: vehicles with dynamic all-wheel steering

Active corrective steering at the front and rear axles increases the driving dynamic and driving stability. At low speeds, the rear wheels are steered in the opposite direction of the front wheels to reduce the steering effort and turning radius. Vehicle handling improves. At high speeds, steering the rear wheels in the same direction as the front wheels improves the vehicle response and driving stability. The vehicle reacts quickly and precisely to steering movements.

Messages

The following messages may appear depending on the vehicle equipment:

 **Steering: malfunction! Please stop vehicle**

The power steering may have failed. Adapt your driving style immediately to compensate for the fact that it may be more difficult to turn the steering wheel, and stop your vehicle in a safe location as soon as possible. Do not continue driving. See an authorized Audi dealer or authorized Audi Service Facility for assistance.

 **Steering: malfunction! Please stop vehicle. Pay attention to distance at side**

The rear axle steering may have failed. More space on the road may be needed at the side of the vehicle, and the turning radius may be much larger. Slow down immediately, and stop your vehicle as soon as possible in a safe location with enough space at the sides of the vehicle. Do not continue driving. See an authorized Audi dealer or authorized Audi Service Facility for assistance.

 **Steering: malfunction! Please stop vehicle** ►

There is a malfunction in the electronic steering lock. You cannot turn the ignition on. Secure the vehicle against rolling before exiting the vehicle ⇒ *page 104*. Do not tow your vehicle because it cannot be steered. See an authorized Audi dealer or authorized Audi Service Facility for assistance.

Steering: malfunction! You can continue driving

There is a malfunction in the steering system. Steering may be more difficult or more sensitive. Adapt your driving style. Have the steering system checked immediately by an authorized Audi dealer or authorized Audi Service Facility. Please note that the red indicator light may turn on after restarting the engine. Do not continue driving if it does.

Steering: malfunction! Adapt driving style. Larger turning radius

The rear axle steering may have failed. The vehicle will have a larger turning radius, and the stability when driving around curves will be comparable to a vehicle without rear axle steering. Drive carefully to an authorized Audi dealer or authorized Audi Service Facility to have the malfunction corrected.

Steering lock: malfunction! Please contact Service

There is a malfunction in the electronic steering lock. Drive immediately to an authorized Audi dealer or authorized Audi Service Facility to have the malfunction repaired.



Dynamic steering: correcting steering wheel position

The steering is reinitializing. The steering wheel will move easily after starting the vehicle. Reinitialization might be necessary if the steering wheel was moved while the engine was switched off. The display turns off if the initialization was successful.

WARNING

Do not tow your vehicle if there is a malfunction in the electronic steering lock because this increases the risk of an accident.

Tips

- If there is a malfunction, the steering wheel may be crooked when driving straight.
- If the  or  indicator light only stays on for a short time, you may continue driving.

All wheel drive (quattro)

Description

Applies to: vehicles with all wheel drive

The all-wheel drive system distributes the driving power variably to the front and rear axle to improve the driving characteristics. It works together with selective wheel torque control, which can activate when driving through curves ⇒ *page 122*.

The all-wheel drive system is designed for high motor power. Your vehicle is exceptionally powerful and has excellent driving characteristics both under normal driving conditions and on snow and ice. Always read and follow safety precautions ⇒ .

WARNING

- Even in vehicles with all wheel drive, you should adapt your driving style to the current road and traffic conditions to reduce the risk of an accident.
- The braking ability of your vehicle is limited to the traction of the wheels. In this way, it is not different from a two wheel drive vehicle. Do not drive too fast because this increases the risk of an accident.
- Note that on wet streets, the front wheels can “hydroplane” if driving at speeds that are too high. Unlike front wheel drive vehicles, the motor RPM does not increase suddenly when the vehicle begins hydroplaning. Adapt your speed to the road conditions to reduce the risk of an accident.

Sport differential

Applies to: vehicles with sport differential

The sport differential distributes the drive power to the rear axle based on the situation. The goal is a high level of agility and ability to accelerate ▶

on curves. The vehicle is very responsive to steering. The settings depend on the selected Audi drive select* mode.

Messages

The following messages may appear depending on the vehicle equipment:

Sport differential: malfunction! Please contact Service

Drive immediately to an authorized Audi dealer or authorized Audi Service Facility to have the malfunction repaired.

Sport differential: temperature too high. Please adapt driving style

The transmission temperature has increased significantly due to the sporty driving manner. Drive in a less sporty manner until the temperature returns to the normal range and the indicator light switches off.

WARNING

Contact an authorized Audi dealer or authorized Audi Service Facility if the sport differential is faulty or malfunctioning. The repair must be performed by trained personnel using the correct oil in order to ensure safety.

Electronic Stabilization Control

Description

Electronic Stabilization Control (ESC) supports driver safety. It reduces the risk of slipping and improves driving stability. ESC detects critical situations, such as if the vehicle is oversteering or understeering, or if the wheels are spinning.

The brakes are applied or the motor torque is reduced in order to stabilize the vehicle.

The following stabilization functions are integrated into the ESC, among others:

Anti-Lock Braking System (ABS)

ABS prevents the wheels from locking when braking. The vehicle can still be steered even during

hard braking. Apply steady pressure to the brake pedal. Do not pump the pedal.

A pulsing in the brake pedal indicates that the system is acting to stabilize the vehicle.

Anti-Slip Regulation (ASR)

ASR reduces drive power when the wheels begin spinning and adapts the power to the road conditions. This will increase the driving stability.

Electronic Differential Lock (EDL)

The EDL applies the brakes to wheels that are slipping and transfers the drive power to the other wheels. This function is not available at higher speeds.

In extreme cases, EDL automatically switches off to keep the brake on the braked wheel from overheating. The vehicle is still functioning correctly. EDL will switch on again automatically when conditions have returned to normal.

Selective wheel torque control

Selective wheel torque control is used when driving on curves. Braking is targeted toward the wheels on the inside of the curve as needed. This allows more precise driving in curves.

Power steering

The ESC can also support vehicle stability through steering.

WARNING

- The ESC and its integrated systems cannot overcome the limits imposed by natural physical laws. This is especially important on slippery or wet roads. If the systems begin acting to stabilize your vehicle, you should immediately alter your speed to match the road and traffic conditions. Do not let the increased safety provided tempt you into taking risks. This could increase your risk of a collision.
- Please note the risk of a collision increases when driving fast, especially through curves and on slippery or wet roads, and when driving too close to objects ahead. There is still a risk of accidents because the ESC and its



integrated systems cannot always prevent collisions.

- Accelerate carefully when driving on smooth, slippery surfaces such as ice and snow. The drive wheels can spin even when these control systems are installed and this can affect driving stability and increase the risk of a collision.

Tips



- The ABS and ASR only function correctly when all four wheels have a similar wear condition. Different tire sizes can lead to a reduction in motor power.
- You may hear noises when the systems described are working.

Operation

The  button (or , depending on the model) for controlling the ESC is located in the center console, in front of the selector lever. The ESC is automatically switched on when the ignition is switched on.



Limiting ESC

In some situations, it may make sense to limit the stabilizing function of the ESC so that the wheels can spin, for example to rock a vehicle to free it when it is stuck or to drive with snow chains. The ESC can also be limited to provide more sporty driving characteristics with fewer stabilizing corrective actions.

- To limit the ESC, press the  button briefly. The  indicator light will turn on.
- To completely reactivate the ESC stabilization function, press the button again. The indicator light turns off.

Switching off ESC

For a more active control of the vehicle where the stabilizing functions of the ESC cannot intervene, the ESC can be switched off.

- To switch off the ESC, press and hold the  button for more than three seconds. The  and **ESC OFF** indicator lights turn on.

- To completely reactivate the ESC stabilization function, press the button again. The indicator lights turn off.

WARNING



- When the ESC is switched off or limited, there will be no vehicle stabilization or it will be limited. The driving wheels could spin and the vehicle could swerve, especially on slick or slippery road surfaces, which increases the risk of an accident.
- Because of the increased risk of an accident, only drive with the ESC switched off or limited when it is necessary. Reactivate the ESC as soon as possible.

Tips

- If the ESC is limited, switched off, or malfunctioning, systems with an automatic braking intervention function may not be fully available.
- If malfunctions occur in other systems or certain driver assist systems are active, the ESC must be switched on by the system. The ESC may switch on automatically and cannot be operated with the button.

Messages

The following messages may appear depending on the vehicle equipment:

 **ABS** /  **Stabilization control (ESC/ABS): malfunction! See owner's manual**

There is a malfunction in the ABS or EDL. This also causes the ESC to malfunction. The brakes still function with their normal power, but ABS is not active.

Drive to an authorized Audi dealer or authorized Audi Service Facility immediately to have the malfunction corrected.

Other indicator lights

If  blinks while driving, the ESC is actively regulating. Operating noises may occur. If the indicator light stays on, the ESC has been switched off due to system needs. The indicator light turns off when the system is fully functional.

Trailer towing

Driving with a trailer

General information

Your vehicle is primarily intended for transporting people and luggage. However, if you drive with a trailer, follow the technical requirements, the operation and driving tips, and the legal regulations.

Driving with a trailer affects the vehicle's energy usage, performance, and wear. It also requires greater concentration.

A retrofitted trailer hitch must be installed according to the instructions provided by the manufacturer ⇒ *page 126*.

WARNING

- Do not transport any people in a trailer due to the risk of fatal injury.
- Only use a ball hitch that is approved for your vehicle. Using a ball hitch that is not approved for your vehicle can lead to issues such as unstable driving behavior or uncoupling of the trailer and increase the risk of an accident. If you have questions, see an authorized Audi dealer or authorized Audi Service Facility.

Operating instructions

Towing capacity

Your vehicle can only be operated with class 1 or class 2 trailers.

Load distribution

Poor cargo load and distribution can negatively impact vehicle handling. Load the vehicle and trailer based on the following criteria as much as possible:

- Store objects in the vehicle luggage compartment, if possible. The vehicle should always carry the heaviest possible load and the trailer should have the lightest possible load.

- Distribute the load in the trailer so that the heavy objects are as close to the axle as possible.
- Secure objects so that they do not slide.
- Utilize the maximum permitted tongue weight if possible.

Speed

Adhere to the legal speed limits. Follow the legal regulations that are applicable in the country where you are operating the vehicle.

As the speed increases, the driving stability of the vehicle and trailer decreases. Therefore you should not exceed the maximum legal speed limit when there are unfavorable road, weather, and/or wind conditions. This especially applies when driving downhill.

Hill

When you start driving uphill or downhill, the vehicle and trailer may tilt or sway sooner than when driving on a level surface. If small swaying movements have already occurred, you can stabilize the trailer by firmly braking immediately. Never attempt to “straighten out” the vehicle and trailer by accelerating.

Downshift before driving on hills to utilize the engine braking effect ⇒ .

Exterior lighting

Follow the legal regulations for lighting on your trailer that are applicable in the country where you are operating the vehicle. If necessary, contact an authorized Audi dealer or authorized Audi Service Facility for more information.

Before you start driving, check all lighting equipment on the trailer while it is hitched to the vehicle.

The headlight range control automatically adjusts the light range of the headlights.

Outside mirrors

Make sure that you can also observe the traffic area behind the vehicle using the exterior mirrors, and use additional exterior mirrors if necessary. Adjust the additional exterior mirrors so that you have a sufficient visibility behind the

vehicle. Follow the local legal regulations for installing additional exterior mirrors.

Engine cooling system

Driving with a trailer means a higher load on the engine and the cooling system. Make sure the cooling system contains enough coolant.

Engine coolant temperature

Pay attention specifically to the coolant temperature display when there are high outside temperatures, and when driving on long inclines ⇒ *page 17*. Shift to a higher gear in a timely manner.

Tires

Set the tire pressure on your vehicle for a “full load”; see the tire pressure sticker ⇒ *page 280*. If necessary, also adjust the tire pressure on the trailer according to the manufacturer’s specifications.

The trailer and the vehicle should be equipped with winter tires when driving in winter temperatures.

Overrun brakes

If your trailer is equipped with an overrun brake, it must be correctly adjusted and function correctly. When using a trailer with overrun brakes, first brake gently then quickly. This reduces the risk of jerking while braking if the trailer wheels lock up.

WARNING

Constant braking causes the brakes to overheat and can substantially reduce braking performance, increase braking distance, or cause complete failure of the brake system.

Note

Attachments retrofitted on the vehicle may cause damage, especially on the trailer hitch ball head. In cases of damage, have the function checked by an authorized Audi dealer or authorized Audi Service Facility.

Tips

- Block the wheels with chocks when parking on inclines if the trailer is loaded.
- Audi recommends having the vehicle inspected between the inspection intervals if you tow a trailer frequently.
- Avoid driving with a trailer during the vehicle break-in period.

Air suspension

Applies to: vehicles with air suspension

Requirement: all vehicle doors must be closed. The Audi drive select **comfort** mode ⇒ *page 117* is selected before you connect the trailer ⇒ .

Setting trailer mode

- ▶ Applies to MMI: select on the home screen: **VEHICLE > Settings & Service > Air suspension: trailer**.
- ▶ Switch trailer mode off again when you are no longer towing a trailer.

When using rear carrier systems that are mounted directly on the trailer hitch ball head, you can also switch trailer mode off manually.

If you have to drive through difficult road conditions temporarily, you can raise the vehicle again after hitching the trailer or after ensuring the tongue weight is correct. Select **Raise** to obtain the maximum ground clearance ⇒ *page 118*.

Note

- Never turn off trailer mode while driving when a trailer is hitched, because then the restrictions for controlling the vehicle level will be turned off.
- Driving with a trailer on unpaved roads when the vehicle is raised may change the vehicle handling. Adapt your speed.
- Note that the vehicle will lower automatically at certain speeds if you have lifted the vehicle manually.
- Be sure to adhere to the applicable tongue weight for your vehicle. Select the Audi

drive select **comfort** mode before connecting the trailer. The tongue weight and vehicle height must be coordinated with one another.

Tips

Even when lowering manually, the vehicle level will not lower more than the amount specified in the Audi drive select **comfort** mode.

Trailer hitch

Introduction

Only use a trailer hitch with a removable ball hitch mount and ball hitch. The trailer hitch must be permitted for the vehicle, the trailer and the permitted total weight of the trailer being pulled. Above all, it must be securely and safely attached to the vehicle trailer.

Never mount a trailer hitch on the bumper. The trailer hitch must be mounted in a way that does not impair the function of the bumper. Do not make any changes to the exhaust system and the brake system.

Check regularly if the trailer hitch is securely mounted. Always follow the instructions given by the trailer hitch manufacturer.

Driving with a trailer

Trailer brakes

If the trailer has its own brake system, then follow the manufacturer specifications. However, the brake system on the trailer must never be connected to the vehicle brake system.

Safety chains

Make sure the safety chains are correctly applied when pulling a trailer. The chains should hang enough so that the trailer can drive around curves. However, they must not touch the ground.

WARNING

If the trailer is equipped with electronic brakes, these brakes cannot be activated by a

factory-installed control system, which increases the risk of an accident.

Retrofit installation

You can find out if your vehicle is equipped with a retrofitted trailer hitch at an authorized Audi dealer or authorized Audi Service Facility.

An authorized Audi dealer or authorized Audi Service Facility knows the specifications for retrofitting a trailer hitch and any necessary technical requirements.

WARNING

- Only have the additional trailer hitch installed by an authorized Audi dealer or authorized Audi Service Facility.
- There is a risk of an accident if the trailer hitch is installed incorrectly.
- For your own safety, read the assembly instructions provided by the trailer hitch manufacturer.

Note

- Connecting the socket incorrectly could cause damage to the vehicle electrical system.
- Longer inclines cannot be driven without a suitable cooling system, especially if the outside temperatures are high. Otherwise, this increases the risk of engine damage.

Assist systems

General information

Safety precautions

Observe the safety precautions for the assist systems, sensors, and cameras ⇒ ⚠.

⚠ WARNING

- As the driver, you have complete responsibility for all driving operations at all times. The assist systems cannot replace the driver's attention. Give your full attention to driving the vehicle, and be ready to intervene in the traffic situation at all times.
- Activate the assist systems only if the surrounding conditions permit it. Always adapt your driving style to the current visual, weather, road, and traffic conditions.
- Loose objects can be thrown around the vehicle interior during sudden driving or braking maneuvers, which increases the risk of an accident. Store objects securely while driving.
- For the assist systems to be able to react correctly, the function of the sensors and cameras must not be restricted. Note the information on sensors and cameras ⇒ *page 128*.

i Tips

- Pay attention to applicable local regulations relating to driving tasks, leaving space for emergency vehicles, vehicle distance, speed, parking location, wheel placement, etc. The driver is always responsible for following the laws that are applicable in the location where the vehicle is being operated.
- You can cancel a steering or braking intervention by the system by braking or accelerating noticeably, steering, or deactivating the respective assist system.
- Always check the assist systems settings before driving. The settings may have been changed, for example by switching off the ignition or by other persons.

System limitations

Observe the limits of the assist systems, sensors, and cameras ⇒ ⚠.

⚠ WARNING

- The use of an assist system cannot overcome the natural laws of physics. A collision cannot be prevented in certain circumstances.
- Warnings, messages, or indicator lights may not be displayed or initiated on time or correctly, for example, if vehicles are approaching very fast.
- Corrective interventions by the assist systems, such as steering or braking interventions, may not be sufficient or they may not occur. Always be ready to intervene.

i Tips

- Due to the system limitations when detecting the surrounding area, the systems may warn or intervene unexpectedly or too late in certain situations. The assist systems may also interpret a driving maneuver incorrectly and then warn or intervene unexpectedly.
- The systems may not function as expected in unusual driving situations, such as driving offroad, on unpaved roads, on loose ground, on inclines, or on grooves in the road.
- The systems may not function correctly in unclear traffic situations, such as turning lanes, exit ramps, construction zones, rises or dips that obstruct visibility, intersections, toll stations, or city traffic.
- The detection of the surrounding area can be limited, for example by vehicles driving ahead or by rain, snow, heavy spray, or light shining into the camera.
- The steering wheel touch recognition may be limited when you wear gloves. Steering intervention requests from the steering assist systems may occur more frequently.
- If accessories have been mounted on the steering wheel, the steering assist systems may be limited. The frequency of steering intervention requests from the steering assist systems may vary as well.

General messages

Driver assistance systems: currently limited. Affected systems will be continuously updated in message memory

If this message appears, one or more driver assist systems is limited or unavailable. To display additional information, select the  tab (messages) in the instrument cluster. Take note of the information and adapt your driving style accordingly.

Surrounding area detection

Sensor and camera coverage areas

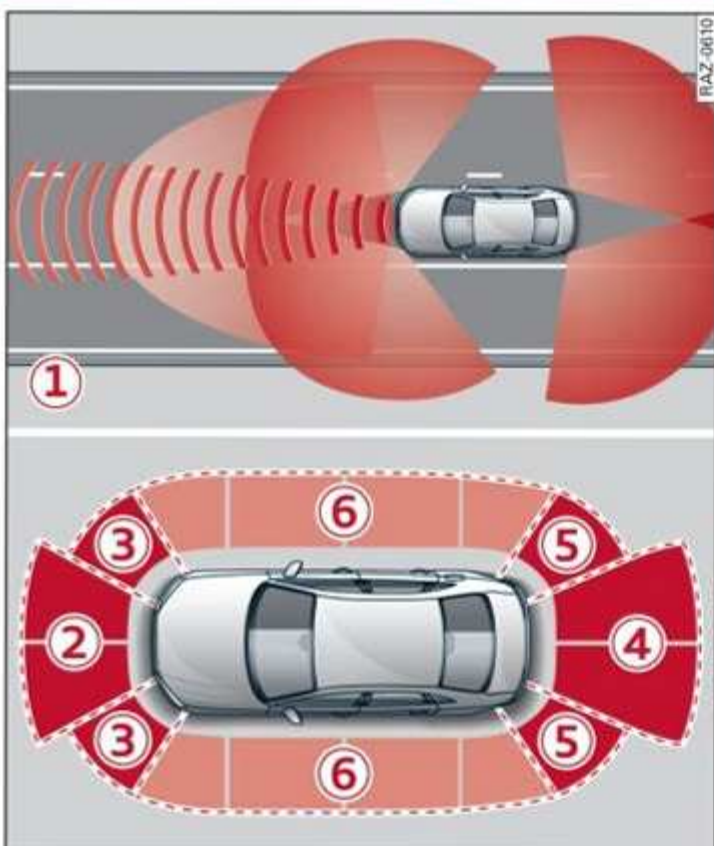

Fig. 92 Sensor coverage area

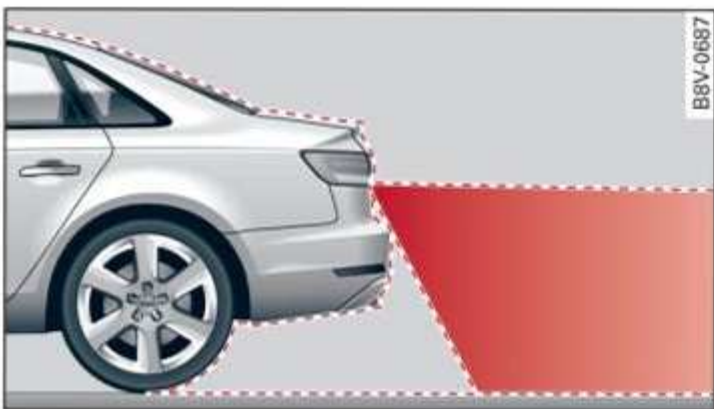

Fig. 93 Rearview camera coverage area

The assist systems analyze the data from various sensors and cameras installed in the vehicle. Do not use any assist systems if there is damage in the area of the sensors and cameras or on the vehicle underbody. Damage can impair the function of the sensors and cameras or cause malfunctions. Have an authorized Audi dealer or authorized Audi Service Facility check their function.

Radar sensors

Depending on the vehicle equipment, the area surrounding the entire vehicle may be detected \Rightarrow fig. 92 ①.

The wheel sensors on the rear corners of the vehicle are positioned so that the adjacent lanes to the left and right are detected on roads with a normal lane width.

Ultrasonic sensors

Depending on vehicle equipment, various areas may be displayed in the MMI using the ultrasonic sensors \Rightarrow fig. 92.

The range of the displays depends on the location of the ultrasonic sensors:

- ② Approximately 4 feet (1.20 m)
- ③ Approximately 3 feet (0.90 m)
- ④ Approximately 5.2 feet (1.60 m)
- ⑤ Approximately 3 feet (0.90 m)
- ⑥ Approximately 3 feet (0.90 m)

The side area ⑥ is detected and evaluated when passing. There may have been changes to the surrounding area after switching the ignition off and on again, after opening the doors, or if the vehicle is left stationary for a period of time. In this case, the area will appear black until the area has been detected and evaluated.

Cameras

Use the camera image on the display to assist you only if it shows a good, clear picture. Keep in mind that the image in the display is enlarged and distorted. Under certain circumstances, objects may appear different and unclear on the display.

The rearview camera can only detect the area marked in red ⇒ *fig. 93*. Only this area is displayed on the upper display ⇒ .

WARNING

- Sensors and cameras have spots in which the surrounding area cannot be detected. Objects, animals, and people may only be detected with limitations or may not be detected at all. Always monitor the traffic and the vehicle's surroundings directly and do not become distracted.
- Sensors may be subject to physical system limitations. External sources of interference, for example from other vehicles, can impair sensor functionality. The assist systems may be limited or may not function as expected.

Note

- Obstacles may disappear from the measurement range when approaching them, even if they were already detected.
- In some situations, the ability of the sensors and cameras to detect and display certain objects may be limited.
 - Objects located above the coverage area, such as bumpers on parked cars, garage doors that are partially open, or objects that are hanging
 - Low obstacles
 - Narrow objects, such as barrier chains, foliage, poles, or fences
 - Projecting objects, such as trailer draw bars
 - Objects with certain surfaces and structures, such as fabric

Tips

- The sensors and cameras and the areas around them must not be obstructed because this can impair the function of the systems that depend on them. Make sure that the sensors and cameras are free of snow, ice, and other deposits. Attachments, stickers, adhesive, or similar objects must

not extend into the visual field of the sensors and cameras.

- On vehicles that have factory-installed license plate brackets on the front of the vehicle, the brackets may only be replaced with ones that are the same size and made of the same material. Do not install any license plate brackets on the front of vehicles that do not have factory-installed brackets. Otherwise, the function of the system could be impaired.
- The function of the sensors and cameras may be limited when light and visibility conditions are poor, for example when driving into a tunnel, when there is glare, or when there are reflective objects.
- External ultrasonic sensors, such as those in other vehicles, can interfere with the sensors.
- The coverage areas of the sensors ⇒ *fig. 92* and cameras ⇒ *fig. 93* are diagrams and do not represent a true-to-scale image of the sensor ranges.
- The system complies with United States FCC regulations and ISED regulations ⇒ *page 325*.

Locations of the sensors and cameras

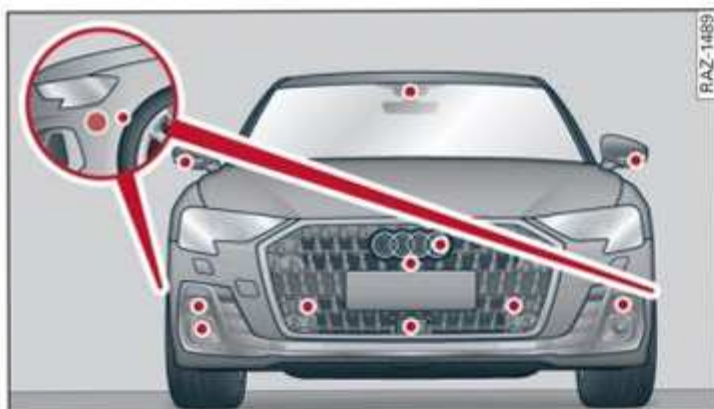

Fig. 94 Front area: sensors and cameras

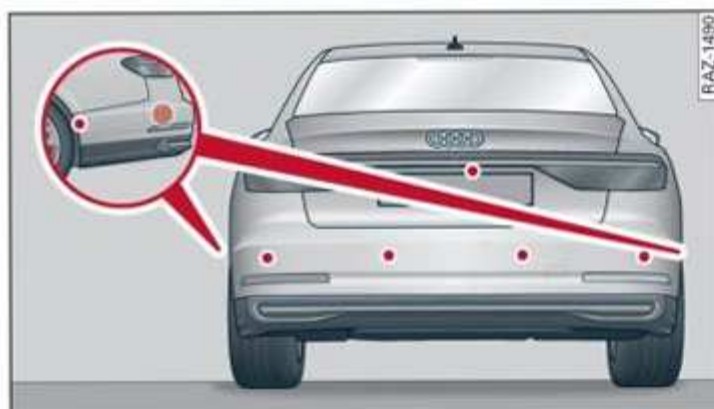

Fig. 95 Rear area: sensors and cameras

Front area

Depending on the vehicle equipment, the following sensors and cameras may be installed:

- Laser scanner in the front of the radiator grille
⇒ ⚠
- Camera behind the windshield
- Peripheral cameras on the exterior mirrors
- Front peripheral camera in the radiator grille
- Night vision camera in the radiator grille
- Front and side ultrasonic sensors
- Radar sensors at the front corners of the vehicle
- Radar sensor in the front in the bumper

Rear area

Depending on the vehicle equipment, the following sensors and cameras may be installed:

- Rearview camera in the luggage compartment lid
- Radar sensors at the rear corners of the vehicle
- Rear and side ultrasonic sensors

⚠ WARNING

Applies to: vehicles with laser scanner

- The surface of the laser scanner can become hot during operation, which increases the risk of burns.
- The laser scanner contains a class 1 laser in accordance with IEC 60825-1:2014. When used according to regulations, the laser is not dangerous. Opening the laser module and removing covers is not permitted. Doing so could cause permanent injuries to the eyes.
- Any repair work on the laser module must be performed by an authorized Audi dealer or authorized Audi Service Facility; otherwise the vehicle's operating license may be voided. Incorrect repairs may cause limited functionality and eye damage.

i Tips

Applies to: vehicles with laser scanner

- The possible emissions are below the threshold for class 1 lasers.
- Complies with 21 CFR 1040.10 and 1040.11, except for deviations pursuant to Laser Notice No. 50, dated June 24, 2007.

i Tips

- The locations of the sensors may differ slightly depending on vehicle equipment.
- Some sensors are installed under vehicle components and cannot be seen from the outside.
- The system complies with United States FCC regulations and ISED regulations
⇒ page 325.

Driver assistance menu





Fig. 96 Center console: driver assistance systems button

In the **Driver assistance** menu, you can turn certain assist systems on or off, or adjust them to your preferences.

Opening the Driver assistance menu

- ▶ Press the  button **1**, or
- ▶ Applies to MMI: Select on the home screen: **VEHICLE > Driver assistance**.



Customizing systems

- ▶ To customize a system, press the  button in the **Driver assistance** menu and select the desired system .
- ▶ Depending on the equipment, you can adjust the systems to your preferences directly in the **Driver assistance** menu .

Switching the systems on and off

Depending on the equipment, it may be in the **profile selection** or the **standard display**.

Vehicles with profile selection

- ▶ To activate all available systems, select the **Maximum** profile.
- ▶ To activate only basic systems or none, select the **Basic** profile, or **All off**¹⁾.
- ▶ To activate single systems individually, first select the **Individual** profile. To switch individual systems on and off in the **Individual** profile, press  and  for the desired system.

Applies to: vehicles with standard display

- ▶ To switch a system on or off, press  for the desired system.



¹⁾ Depending on the equipment

WARNING

Observe the safety precautions and note the limits of the assist systems, sensors, and cameras \Rightarrow page 127 to \Rightarrow page 130.

Tips

Applies to: vehicles with profile selection

- You can select profiles by pressing their names or by pressing the  **1** button repeatedly until the profile is active.
- To list systems included in a profile, select  on the upper display.

Parking aid menu

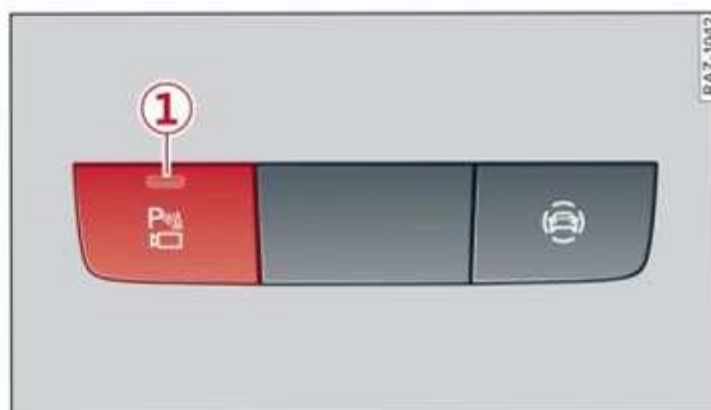





Fig. 97 Center console: parking aid button

In the **Parking aid** menu, you can turn certain parking aids on or off or adjust them to your preferences.

- ▶ Applies to MMI: Select on the home screen: **VEHICLE > Parking aid**, or
- ▶ Press the button **1** in the center console and press  in the upper display when the parking system is active.

You can turn certain systems on/off by pressing  or adjust them to your preferences .

Possible settings

The possible settings depend on the vehicle equipment. Some settings are only available via  and under certain conditions.

- **Automatic activation** \Rightarrow page 170
- **Front and rear volume** \Rightarrow page 171
- **Entertainment fader** \Rightarrow page 171.

- **Clean rearview camera** ⇨ *page 172*
- **View** ⇨ *page 174*
- **Rear cross-traffic assist** ⇨ *page 176*
- **Maneuver assist** ⇨ *page 188*



WARNING

Observe the safety precautions and note the limits of the assist systems, sensors, and cameras ⇨ *page 127* to ⇨ *page 130*.

Driving information

Speed warning system

Description

Applies to: vehicles with speed warning system

The speed warning system helps to stay below a specified maximum speed. A warning threshold can be set in the MMI for this purpose.

Once the speed slightly exceeds the stored threshold, the speed warning system will provide an alert using an indicator in the instrument cluster and a warning tone. Once the speed drops below the stored maximum speed, the indicator will turn off.

Setting a threshold is recommended if you would like to be reminded when you reach a certain maximum speed. Situations where you may want to do so include driving in a country with a general speed limit or if there is a specified maximum speed for winter tires.

Tips

Regardless of the speed warning system, you should always monitor your speed using the speedometer and make sure you are following the legal speed limit.

Setting the warning threshold

Applies to: vehicles with speed warning system

You can adjust the warning threshold to your preferences in the **Driver assistance** menu ⇒ *page 131*. The settings depend on the vehicle equipment.

Possible settings:

Speed warning – adjust the speed for the warning threshold.

Messages

Applies to: vehicles with speed warning system

The following messages may appear depending on the vehicle equipment:

 **Manually set (XY) speed limit warning threshold exceeded**

The stored speed was exceeded.

Camera-based traffic sign recognition

Description

Applies to: vehicles with camera-based traffic sign recognition

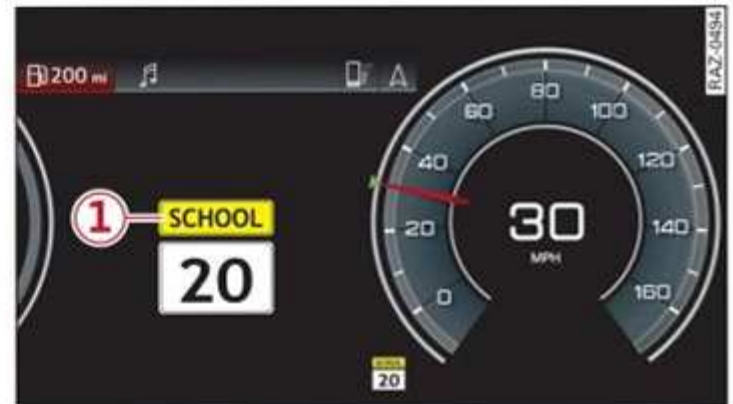

Fig. 98 Instrument cluster: traffic sign recognition

The traffic sign recognition shows the traffic signs detected by the front camera in the instrument cluster display and in the head-up display*. Data from the navigation system is also included in the display. Up to three traffic signs can be displayed in the instrument cluster at once. The speed limit that is currently applicable is displayed in the status bar. If necessary, it will be hidden if the system detects that turning right is prohibited at a red light. The display in the head-up display* can be switched off ⇒ *page 30*.

Within the limits of the system and depending on the market, speed limit restrictions ① in school zones, highways, construction zones, or at night may be displayed.

Limitations

The traffic sign recognition is subject to certain system limitations and may be unavailable or only partially available in the following situations:

- When visibility is poor, such as in snow, rain, fog, or heavy spray
- When there is glare, for example from oncoming traffic or the sun
- At high speeds
- If the camera's visual field ⇒ *page 128* is covered, for example by dirt or stickers. For information on cleaning, see ⇒ *page 293*.

- If the traffic signs are completely or partially covered, for example by trees, snow, dirt, or other vehicles
- If traffic signs do not conform to the standard format
- If traffic signs are damaged or bent
- If traffic signs are displayed on sign holders with electronic signs
- If the traffic signs or the roadways have changed, and the navigation data is no longer up-to-date

WARNING

- Observe the safety precautions and note the limits of the assist systems, sensors, and cameras ⇒ *page 127* to ⇒ *page 130*.
- Under some circumstances, traffic sign recognition may not detect traffic signs correctly or detect them at all. As a result, the system may not display the correct speed limit or any speed limit.

Tips

- Traffic sign recognition only informs and warns about speed limits. Depending on the vehicle equipment, additional driver assistance systems can adjust the vehicle speed.
- The display in the instrument cluster is based on the units of measurement used for speed in the country where the vehicle is being operated. As a result, a display of **50** in the instrument cluster can mean either mph or km/h, depending on the country.

Operation

Applies to: vehicles with camera-based traffic sign recognition

Accessing traffic sign recognition

Depending on the equipment, the vehicle may have a driver assistance display with or without area view.

- ▶ Without area view: Select in the instrument cluster: Vehicle functions tab > **Traffic signs**.
- ▶ With area view: Select in the instrument cluster:  tab.

Setting a traffic sign based speed warning

You can adjust the speed warning threshold to your preferences in the **Driver assistance** menu ⇒ *page 131*. The settings depend on the vehicle equipment.

Possible settings:

Speed warning – you can select a warning threshold. If you exceed this, then the current detected speed limit will be shown in the display with an exclamation point for the duration that it is exceeded and it will blink for a short time.

Messages

Applies to: vehicles with camera-based traffic sign recognition

If  is displayed when there is a malfunction, the camera-based traffic sign recognition functions may be unavailable or may be limited.

A message that indicates the cause and possible solution may appear with some displays. The weather conditions may be too poor or a sensor may be covered. Clean the area in front of the sensors ⇒ *page 130* and try to turn the system on again later.

If the malfunction remains, drive to an authorized Audi dealer or authorized Audi Service Facility immediately to have the malfunction corrected.

The following messages may appear depending on the vehicle equipment:

 **Traffic sign recognition: currently limited.**
See owner's manual

This message appears if navigation system data is not available, for example on newly-constructed roads. The speed limit display will be temporarily limited, which increases the risk of an incorrect display.

No traffic sign information available

Depending on the area, there is no valid navigation data and no speed limits were detected. This may also appear if there is a recommended speed, but no speed limit (for example when driving on and off the expressway).

Traffic light information

Description

Applies to: vehicles with traffic light information

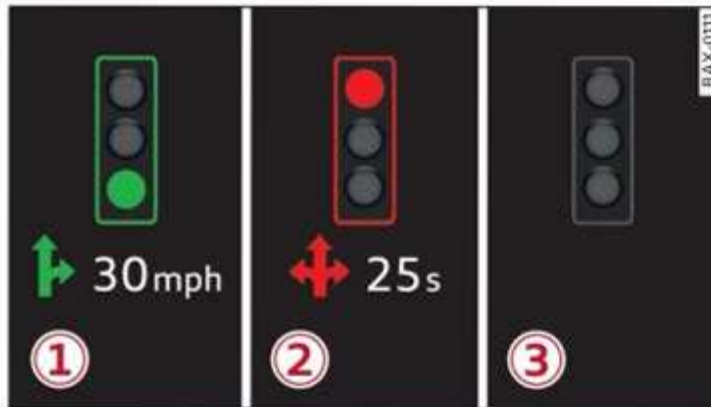

Fig. 99 Instrument cluster: traffic light information display

The traffic light information gives you a speed recommendation in order to reach the next traffic light when it is green ①, or it informs you of the wait time at the next red light ②. Once traffic light data is received, the traffic light information will be displayed in the instrument cluster and in the head-up display*. If the vehicle is in an area with traffic light information but cannot receive a traffic light signal, then a gray traffic light symbol will be displayed ③.

General information

The traffic light information is subject to system limitations and may be unavailable or only partially available in the following situations:

- If the permitted speed limit is exceeded
- If driving below a certain speed limit
- If the next traffic light is less than approximately 100 feet (30 m) away
- If the estimated wait time at a red light is less than four seconds
- If there is no traffic light data available
- If emergency response vehicles or public transit systems are active
- If traffic lights are in construction zones or being serviced
- If there are warnings from the camera-based traffic sign recognition*
- If the camera-based traffic sign recognition* is malfunctioning or not available
- If the data connection has been interrupted

- If data transmission is deactivated in the privacy settings
- If the subscription has expired

If this is the case, the menu item will be grayed-out or it will not be possible to select it.

⚠ WARNING

- When traffic light information is shown, also always pay attention to the traffic situation, the distance to other vehicles, and the area around the vehicle. The driver is always responsible for assessing the traffic situation.
- Always adapt your speed to the current weather, road and traffic conditions. The displayed information must never cause you to ignore legal traffic regulations and pose a safety risk.
- Regardless of the traffic light information, you should always monitor your speed using the speedometer and make sure you are adhering to the legal speed limit.
- The traffic light information does not adjust your vehicle's speed to the speed recommendation shown in the display.
- Observe the safety precautions and note the limits of the assist systems, sensors, and cameras ⇨ [page 127](#) to ⇨ [page 130](#).

i Tips

- Traffic light information was only available in select cities at the time this manual was printed.
- Traffic light information is not available nationwide.
- The functions depend on the navigation data* being up-to-date and correct identification by the traffic sign recognition*.
- Incorrect values from the camera-based traffic sign recognition* or outdated navigation system* map data can result in missing or incorrect display images.
- Certain traffic lights can automatically adjust to the current traffic situation. If this occurs, the display of traffic light information can change suddenly.

- The traffic signs on the road always take priority over the display. The driver is always responsible for adhering to the regulations applicable in the country where the vehicle is being operated.
- Units of measurement and language settings are displayed based on how they were set in the MMI system settings ⇒ *page 246*.

Operation

Applies to: vehicles with traffic light information

Switching traffic light information on and off

You can turn the traffic light information on or off in the **Driver assistance** menu ⇒ *page 131*.

Accessing traffic light information

Depending on the equipment, the vehicle may have a driver assistance display with or without area view.

- ▶ Without area view: Select in the instrument cluster: Vehicle functions tab > **Traffic signs**.
- ▶ With area view: Select in the instrument cluster:  tab.

Tips

If another tab or another function is selected in the instrument cluster, the traffic light information will appear in the status bar on the instrument cluster.

Messages

Applies to: vehicles with traffic light information

The following messages may appear depending on the vehicle equipment:

Malfunction! See owner's manual

The system could not be configured, for example due to a network malfunction. Switch the ignition off and shut down the vehicle to restart the system. Wait several minutes until the vehicle has shut down completely and then switch the ignition back on.

Function currently unavailable. See owner's manual

There is a temporary system malfunction. Check if one or more of the following situations applies and correct the issue if necessary:

- Traffic light information is switched off
- Data transmission is deactivated
- The vehicle is not equipped with traffic sign recognition.
- There is no valid license
- Traffic light information is not available in that area

Lap timer

Introduction

Applies to: vehicles with lap timer

You can record and evaluate lap times with the lap timer. You can operate the lap timer using the multifunction steering wheel ⇒ *page 16*.

Opening the lap timer

- ▶ Select in the instrument cluster: Vehicle functions tab >  button > **Lap times**.

An additional indicator will appear in the head-up display*.

WARNING

Your focus should always be on driving your vehicle safely. As the driver, you have complete responsibility for safety in traffic. To reduce the risk of an accident, only use the lap timer functions in such a way that you always maintain complete control over your vehicle in all traffic situations.

Tips

You can retrieve information from the trip computer while the lap timer stopwatch is running.

Lap times and timing

Applies to: vehicles with lap timer



Requirement: the lap timer must be open ⇒ *page 136*.

Timing laps

- ▶ To start timing manually, select **Start lap 1** in the menu.
- ▶ To start timing automatically as soon as you begin to drive, select **Start lap 1 by driving off** or **Start by driving off** in the menu.
- ▶ To start timing a new lap after driving a lap, select **New lap** in the menu. This starts timing the next lap at the same time.

After completing a lap, the difference between the last lap and the previous best lap time will be indicated with a **-** or **+**.

Pausing timing and displaying a split time

- ▶ To take a break , select **Pause** in the menu.
- ▶ To resume timing, select **Resume** in the menu.
- ▶ To display a split time, select **Split time** in the menu. The split time  appears for approximately ten seconds in the instrument cluster. The current lap timing will continue running.

Canceling lap timing

The timing of the current lap will stop. The lap time will be erased and will not be included in the statistics.

- ▶ Select **Cancel lap** in the menu.

Resetting the time

- ▶ Select **Reset lap times** in the menu.



Tips



- A maximum of 99 lap times can be measured.
- If timing is paused, you can continue it later even if you switch the ignition off.
- Saved lap times cannot be individually deleted from the total results.
- The saved lap timer values will remain after switching the ignition off.

Lap statistics

Applies to: vehicles with lap timer

Displaying lap statistics

You can display the number of laps driven , the fastest lap **+**, the slowest lap **-**, and the average time  in the instrument cluster.

- ▶ Select in the instrument cluster: Vehicle functions tab >  button > **Lap statistics**.
- ▶ Turn the thumbwheel down or up to display the individual lap times.
- ▶ To return to the lap timing that was started, select the  button > **Lap times**.

Resetting lap statistics

Requirement: the lap statistics menu must be displayed.

- ▶ To reset the lap statistics, press and hold the left thumbwheel until the message **No lap times have been recorded yet.** appears.

Tips

The lap statistics list the lap times for the last 30 laps. The fastest and slowest lap times out of up to 99 measured laps are also displayed.

Night vision assist



Description

Applies to: vehicles with night vision assist

Night vision assist helps you when it is dark by using an infrared camera to monitor the area in front of your vehicle, within the limits of the system. It can display objects up to a distance of approximately 1,000 feet (300 m).

Pedestrian and wild animals are detected by measuring the temperature difference between the object and the background. Pedestrians and wild animals will not be detected if the temperature difference is too small. The pedestrian and wild animal marking feature is deactivated at temperatures above approximately 77 °F (+25 °C) and when it is light outside.

The thermal image detected by the camera is displayed in the instrument cluster. Warm areas generally appear lighter and cold areas appear darker.

The camera for the night vision assist is located in the vehicle's radiator grille  *page 130*. Make sure the night vision camera is not covered by 

stickers, deposits, or any other obstructions because this can impair the night vision assist function. Follow the information about cleaning ⇒ *page 293*.

WARNING

- Observe the safety precautions and note the limits of the assist systems, sensors, and cameras ⇒ *page 127* to ⇒ *page 130*.
- Night vision assist can only detect pedestrians and wild animals located within the range of the infrared camera.
- Night vision assist cannot detect pedestrians or wild animals and mark them if:
 - They are not in an upright position, for example if they are sitting or lying down and/or
 - The silhouette in the display appears incomplete or interrupted, for example because the pedestrian is partially behind a vehicle or an animal is partially covered by tall grass.
- Never attempt to swerve around animals if doing so would endanger you or other road users.



Tips

- Even though the system evaluates the shape and heat given off by all detected objects, there are limits to the system. There may be false warnings.
- For technical reasons, the image pauses in split second intervals.

Switching on and off

Applies to: vehicles with night vision assist

You can turn the night vision assist on or off in the **Driver assistance** menu ⇒ *page 131*. The settings depend on the vehicle equipment.

- ▶ The AUTO light function must be selected for the night vision assist to automatically activate when it is dark.
- ▶ Switch on the low beams manually to activate night vision assist immediately. To do so, press  on the light switch module ⇒ *page 56*, *fig. 39* and select .

When activated, the  tab appears in the instrument cluster.

- ▶ Select in the instrument cluster:  tab

Tips

When the night vision assist tab is selected in the instrument cluster and the low beams are switched off, the thermal image display disappears only after you have exited the tab.

Marking and warning

Applies to: vehicles with night vision assist



Fig. 100 Instrument cluster: pedestrian marking and warning







Highlighting detected pedestrians and wild animals

Within the limits of the system, the night vision assist can detect pedestrians and wild animals that are between approximately 32 feet (10 m) and 295 feet (90 m) in front of the vehicle and within the detection zone. Animal recognition is not active within highly developed areas. The system only detects large wild animals such as deer. When it is dark outside and the low beams are switched on, detected objects are marked in yellow , within the limits of the system.

Pedestrian and wild animal warning

This system limits are based on the vehicle speed and steering angle. Pedestrian and wild animal warning encourages you to pay more attention.

If there are pedestrians or wild animals in front of your vehicle that could pose a danger, the system will direct your attention to this. ▶

- Pedestrians or wild animals are highlighted in red in the instrument cluster ② and the  or  symbol turns on ②.
- When the head-up display* is switched on, the additional indicator  or  appears.
- A chime will sound if something is detected.
- If the night vision assist thermal image is replaced by another display (such as the on-board computer), the red  or  indicator light will appear if there is a pedestrian or wild animal warning.

The  symbol will appear when pedestrian and wild animal detection is not available.

Marking light*

To direct attention to the pedestrian, the pedestrian can be illuminated by the headlights when there is a pedestrian warning.

This occurs at speeds above approximately 35 mph (60 km/h) if you are outside of illuminated areas and no detected vehicles are shown. The marking light is not used for wild animals. The high beam assistant* controls the marking light* ⇒ *page 57*.

Adjusting the contrast

Applies to: vehicles with night vision assist

Requirement: the night vision assist must be switched on and the  tab must be displayed.

- ▶ Applies to MMI: Select on the home screen: **VEHICLE > Driver assistance > (⊙) > Night vision assist**.
- ▶ To set the desired contrast, move the slider.

Messages

Applies to: vehicles with night vision assist

The following messages may appear depending on the vehicle equipment:

 **Night vision assist: currently unavailable.**
See owner's manual

The system is not functioning correctly at the time, so it has been switched off. If the malfunction persists, drive immediately to an authorized Audi dealer or authorized Audi Service Facility to have the malfunction repaired.

Integrated Toll Module

Description

Applies to: vehicles with Integrated Toll Module

Depending on the region, you can pay toll fees in certain countries using the Integrated Toll Module (ITM). It replaces a separate transponder for detecting toll fees. The system electronics are integrated in the rearview mirror housing.

To use the ITM in toll zones, you must register and activate it.

Registration

- ▶ Applies to: MMI: Select on the home screen: **VEHICLE > Settings & Service > Integrated Toll Module**.
- ▶ Note the Integrated Toll Module ID.
- ▶ To register the ITM, go to the displayed web address and follow the instructions.

Activation

- ▶ To activate the ITM, press  in the MMI.

Entering the number of passengers

Depending on the number of passengers and the region, a lower toll fee may be charged. You must either enter the number of passengers or deactivate the ITM based on the laws applicable in the area where you are driving.

- ▶ To enter the number of passengers, select the appropriate button in the MMI.
- ▶ To deactivate the ITM, press  in the MMI.

Tips

- The driver is responsible for specifying the correct number of passengers and activating or deactivating the ITM.
- Malfunctions can occur when detecting tolls if both the ITM and transponder are activated. Deactivate the system not being used or remove it as necessary.
- If a rearview mirror is replaced, you must register the new ITM and remove the old ITM from the account.
- The system complies with United States FCC regulations and ISED regulations
⇒ *page 325*.

Display

Applies to: vehicles with Integrated Toll Module

The selected number of passengers is displayed in the MMI status bar ⇒ *page 25*.

The  symbol in the status bar and a notification in the MMI will indicate if there is a faulty connection between the ITM and the MMI or if the ITM is faulty. If the connection interference continues or the ITM is faulty, drive immediately to an authorized Audi dealer or authorized Audi Service Facility.

Driver assistance

Cruise control system

Description

Applies to: vehicles with cruise control system

The **cruise control system** assists you in maintaining a constant speed above approximately 15 mph (20 km/h). The system maintains the desired speed by braking and accelerating.

! WARNING

- Observe the safety precautions and note the limits of the assist systems, sensors, and cameras ⇨ *page 127* to ⇨ *page 130*.
- The cruise control system is only an assist system, and the driver is still responsible for operating the vehicle. The driver is especially responsible for braking, controlling the speed, and maintaining the distance to other vehicles.
- Switch the cruise control off temporarily when driving in turning lanes, highway exits, or in construction zones. This prevents the vehicle from accelerating to the stored speed when in these situations.

! Note

Before driving downhill a long distance on a steep hill, decrease your speed and select a lower gear. This makes use of the engine braking effect and reduces the load placed on the brakes.

Display overview

Applies to: vehicles with cruise control system

Indicator lights and messages in the speedometer inform you about the driving situation and the settings. The displays depend on the country and equipment.

Indicator lights

CRUISE /  - the cruise control system is switched on and actively controls the set speed.

An additional indicator will appear in the head-up display*.

! WARNING

Observe the safety precautions and note the limits of the assist systems, sensors, and cameras ⇨ *page 127* to ⇨ *page 130*.

Switching the system on

Applies to: vehicles with cruise control system



Fig. 101 Operating lever: switching the system on

Requirement: the ignition must be switched on.

- ▶ To switch the system on, pull the lever toward you to position ①.

! WARNING

- Observe the safety precautions and note the limits of the assist systems, sensors, and cameras ⇨ *page 127* to ⇨ *page 130*.
- If the brakes are malfunctioning (for example, overheating) while the cruise control system is switched on, the regulating functions may shut off automatically.

Preselecting or activating a cruise control speed

Applies to: vehicles with cruise control system

When the vehicle is stationary, you can preselect the speed to be maintained, or you can select the speed while driving.

Requirement: the system must be switched on.

- ▶ To preselect a cruise control speed when the vehicle is stationary, tap the lever toward  ⇨ *page 141*, *fig. 101*.
- ▶ To activate the cruise control speed, pull the lever toward position ② while driving. ▶

- ▶ To set the current driving speed as the cruise control speed, press the button ① on the lever.

Changing the cruise control speed

Applies to: vehicles with cruise control system

Requirement: the system must be switched on.

- ▶ To increase or decrease the cruise control speed in small increments, tap the lever up to the first level toward ⊕/⊖ ⇒ *page 141, fig. 101*.
- ▶ To increase or decrease the cruise control speed in larger increments, tap the lever up to the second level toward ⊕/⊖.
- ▶ To increase or decrease the cruise control speed continuously, tap and hold the lever at the first or second level toward ⊕/⊖.

Overriding or deactivating the cruise control speed

Applies to: vehicles with cruise control system

You can override or deactivate the cruise control system. When you deactivate the system, your cruise control speed will be stored and you can resume that speed.

Requirement: the system must be switched on and the regulated speed must be activated.

Overriding

- ▶ To temporarily override the cruise control speed, press the accelerator pedal.
- ▶ To resume the stored regulated speed, remove your foot from the accelerator pedal.

If you override the cruise control system for a long period of time, the cruise control system will be deactivated.

Deactivating

- ▶ To deactivate the cruise control speed, press the lever to position ③ (not locked into place) ⇒ *page 141, fig. 101*, or
- ▶ Press the brake pedal.

WARNING

Resting your foot on the accelerator pedal could override the cruise control. Braking in-

terventions and corrective actions by the system may not occur.

Switching the system off

Applies to: vehicles with cruise control system

If you do not want to use the cruise control system for a longer period of time, you can switch it off.

- ▶ To switch the system off, press the lever toward ③ (locked into place) ⇒ *page 141, fig. 101*.

The indicator light will turn off and the set speed will be cleared.

Messages

Applies to: vehicles with cruise control system

If **CRUISE** or  is displayed when there is a malfunction, the cruise control system functions may be unavailable or limited.

A message that indicates the cause and possible solution may appear with some displays. The weather conditions may be too poor or a sensor may be covered. Clean the area in front of the sensors ⇒ *page 130* and try to turn the system on again later.

If the malfunction remains, drive to an authorized Audi dealer or authorized Audi Service Facility immediately to have the malfunction corrected.

Efficiency assist

General information

Applies to: vehicles with efficiency assist

Efficiency assist can assist with predictive information in order to reduce fuel consumption. Depending on vehicle equipment, the system may access data from the navigation system, the camera behind the windshield, and the radar sensors.

WARNING

Observe the safety precautions and note the limits of the assist systems, sensors, and cameras ⇒ *page 127* to ⇒ *page 130*.

i Tips

- The functions depend on the navigation data* being up-to-date and correct identification by the traffic sign recognition*.
- The system only detects traffic signs that specify a speed limit.
- Except for the road network, which is recorded in the navigation system's map information, certain functions may not be available.

Efficiency assist menu

In the **Efficiency assist** menu, you can turn the efficiency assist functions on or off, or adjust them to your preferences. The possible settings depend on the vehicle equipment.

Applies to MMI: Select on the home screen: **VEHICLE > Efficiency assist**.

Possible settings

- **Predictive messages** ⇒ *page 144*.



! WARNING





Observe the safety precautions and note the limits of the assist systems, sensors, and cameras ⇒ *page 127* to ⇒ *page 130*.

Situation symbols

Depending on vehicle equipment, the following symbols may be shown. The symbols indicate the situation to which the efficiency assist is responding.

Some symbols will only appear if **Predictive messages** are turned on. Some symbols only appear if the **Predictive control** is turned on and the Adaptive cruise assist* is actively controlling.

Symbol	Description
	Slow down (predictive messages only)
	Speed limit (example)
	Speed limit removed

Symbol	Description
	Exit ahead
	Intersection ahead
	Traffic circle ahead
	(predictive control only) If the indicator light turns on in green and red, it is indicating that there is a difference between the speed limit and the set speed.

! WARNING

Observe the safety precautions and note the limits of the assist systems, sensors, and cameras ⇒ *page 127* to ⇒ *page 130*.

i Tips

The display in the instrument cluster is based on the units of measurement used for speed in the country where the vehicle is being operated. As a result, a display of 50 in the instrument cluster can mean either mph or km/h, depending on the country.

Predictive messages

Applies to: vehicles with efficiency assist

The  symbol appears in the instrument cluster display when the efficiency assist recommends removing your foot from the accelerator pedal. Symbols indicate the situation to which the system is responding ⇒ *page 143*, *Situation symbols*.

Requirements

- The cruise control system* or the adaptive cruise assist* controls must not be active.
- The vehicle speed must be at least 20 mph (30 km/h).
- The remaining distance until the situation is reached must be large enough to allow the system to react to the situation. ▶

Switching Predictive messages on or off

You can turn the predictive messages on or off in the **Efficiency assist** menu ⇒ *page 143*.

WARNING

- Observe the safety precautions and note the limits of the assist systems, sensors, and cameras ⇒ *page 127* to ⇒ *page 130*.
- Pay attention to traffic and the area around your vehicle when efficiency assist is switched on. The driver is always responsible for assessing the traffic situation.

Tips

- The traffic signs on the road always take priority over the display. The driver is always responsible for adhering to the regulations applicable in the country where the vehicle is being operated.
- When a route is planned using the navigation system*, then system displays messages based on an assumed route. Without route guidance, the system displays messages based on an assumed route.
- The wording of the message may vary depending on the Audi drive select* mode and the selector lever position that are selected. No messages are displayed when in the "S" driving program.

Adaptive cruise assist

General information

Applies to: vehicles with adaptive cruise assist

Depending on the vehicle equipment, the adaptive cruise assist may consist of the following functions:

Within the limits of the system, the **adaptive speed assist** assists you while driving in controlling the speed and the set distance to the vehicle driving ahead. If the system detects a vehicle driving ahead, the adaptive speed assist can brake and accelerate your vehicle within the limits of the system. On open roads with no traffic, it functions like a cruise control system. The stored speed is maintained. When approaching a vehicle driving ahead, the adaptive speed assist auto-

matically brakes to match that vehicle's speed and then maintains the set distance as much as possible. Once the system does not detect a vehicle driving ahead, adaptive speed assist will accelerate up to the set speed.

Within the limits of the system, **Lane guidance** provides corrective steering to assist the driver with keeping the vehicle in the center of the lane as much as possible. You can adjust if the adaptive cruise assist will provide support with lane guidance ⇒ *page 148*, *Switching lane guidance on and off*.

In **stop-and-go traffic and in traffic jams**, the vehicle may brake to a full stop and then may also start driving again automatically under certain conditions.

Applies to: vehicles with traffic jam assist: In **traffic jams or in stop-and-go traffic**, the **traffic jam assist** can assist you in staying within the lane detected by the system ⇒ *page 149*.

Applies to: vehicles with predictive control: **predictive control** can adjust the speed based on traffic and road conditions ⇒ *page 150*, *Predictive control*.

WARNING

Observe the safety precautions and note the limits of the assist systems, sensors, and cameras ⇒ *page 127* to ⇒ *page 130*.

Tips

The system complies with United States FCC regulations and ISED regulations ⇒ *page 325*.

Limitations

Applies to: vehicles with adaptive cruise assist

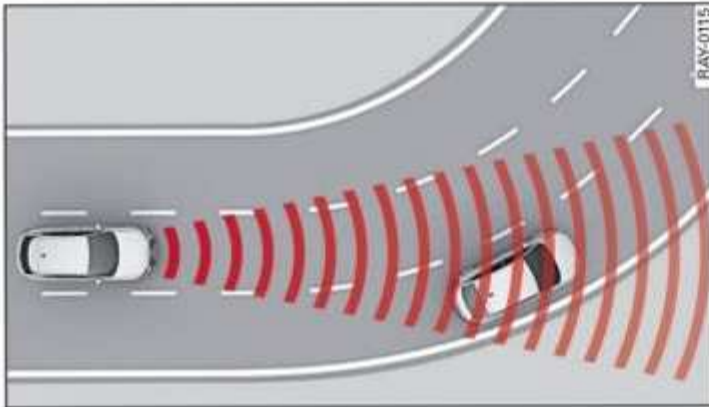

Fig. 102 Example: driving into a curve

In some situations, the adaptive cruise assist function is limited and you must assume control of the vehicle when necessary, for example by applying the brakes.

- When driving into a curve ⇨ *fig. 102* and out of a curve, the system may react to a vehicle in the neighboring lane and apply the brakes. You can override the system by pressing the accelerator pedal briefly.
- The system works with the various sensors and cameras in the vehicle. Vehicles can only be detected once they are within the area and range covered by the sensors ⇨ *page 128, fig. 92*.
- When driving around tight curves, a vehicle driving ahead that was previously detected may no longer be detected, and the adaptive cruise assist may accelerate unexpectedly.
- The system does not react to a stationary vehicle in the same lane if it expects that you can easily drive around the stationary vehicle by turning the steering wheel.
- The system cannot react to stationary objects, such as vehicles at the end of a traffic jam, especially when traveling at high speeds.
- The system has a limited ability to detect vehicles that are a short distance ahead, off to the side of your vehicle, or moving into your lane.
- Objects that are difficult to detect, such as motorcycles, vehicles with high ground clearance, or vehicles with an overhanging load, may be detected late or not detected at all.

- The system does not respond to people, animals, or objects that are crossing or approaching from the opposite direction.

WARNING

Observe the safety precautions and note the limits of the assist systems, sensors, and cameras ⇨ *page 127* to ⇨ *page 130*.

Display overview

Applies to: vehicles with adaptive cruise assist

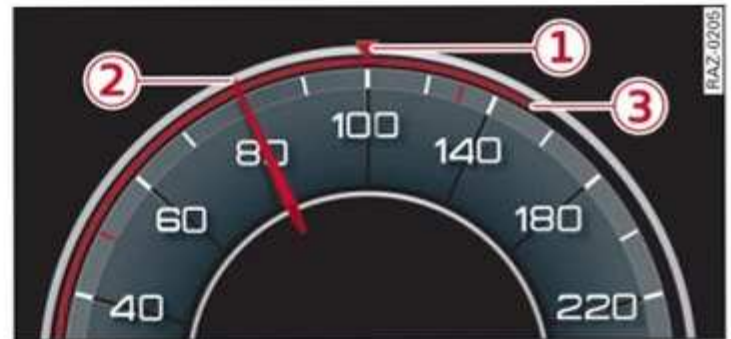

Fig. 103 Instrument cluster: display in speedometer

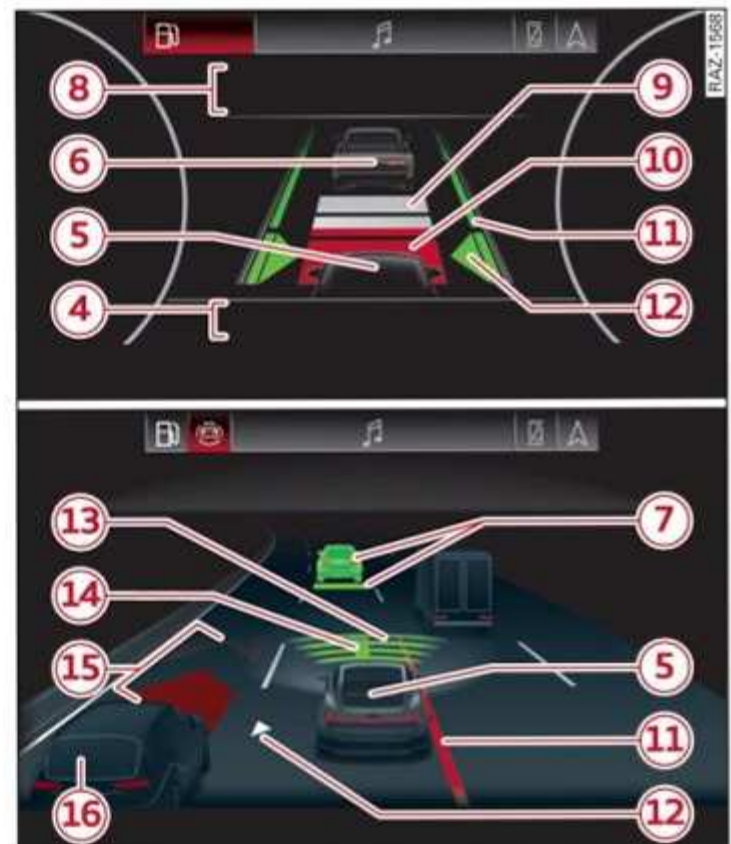

Fig. 104 Instrument cluster: driver assistance display with or without area view

The driving situation and the settings are displayed in the instrument cluster ⇨ *fig. 103*. The displays depend on the country and equipment. ▶

Display in the speedometer

The display in the speedometer is not available in all layouts*.

- ① Marking for the set speed
- ② Current vehicle speed
- ③ Available speed range for adaptive cruise assist (example)

View in the driver assistance display

Depending on the equipment, the vehicle may have a driver assistance display with or without area view.

The driver assistance display without area view ⇒ *fig. 104* (top) provides information about the system status. The display only appears if it was opened in the trip computer ⇒ *page 18*.

The driver assistance display with area view ⇒ *fig. 104* (bottom) will also show other vehicles that are detected, within the limits of the system. The display of the objects will be simplified and might differ from the actual objects. The area view will only appear if the  tab has been selected in the instrument cluster.

- ④ Messages and settings
- ⑤ Your vehicle
- ⑥ Detected vehicle driving ahead
- ⑦ Highlight on the vehicle for which the system is currently adjusting
- ⑧ Messages and settings
- ⑨ Set target distance
- ⑩ If you fall below the set distance, the distance bars turn red from the bottom upward.
- ⑪ Lane departure warning availability or intervention display
- ⑫ Availability of lane guidance for adaptive cruise assist
- ⑬ Width of the sensor coverage area
- ⑭ Green markings in the direction of the vehicle for which the system is currently adjusting
- ⑮ Side assist display
- ⑯ Vehicle detected in the adjacent lane

Indicator lights

 – The speed/distance control is active. No vehicles were detected ahead. The stored speed is maintained.

 – The speed/distance control is active. A vehicle was detected ahead. The system controls the speed and distance from the vehicle driving ahead, and accelerates and brakes automatically.

Applies to: vehicles with traffic jam assist

 – Traffic jam assist with improved lane guidance is active ⇒ *page 149*.

 – The speed/distance control is active but the vehicle is not ready to drive. A vehicle was detected ahead. Your vehicle is stationary and will not start driving automatically ⇒ *page 154*.

 – The speed/distance control is active but the vehicle is not ready to drive. No vehicles were detected ahead. Your vehicle is stationary and will not start driving automatically.



 – The vehicle has been stationary for too long and is not ready to drive. The indicator light and a message indicate that the ready to drive status can be activated again ⇒ *page 154, Starting to drive with adaptive cruise assist*.

 – Take over. The braking power is not sufficient ⇒ *page 149, Brake intervention request* or the safe start monitor is providing a warning ⇒ *page 154*.

 – Lane guidance is active.

 – Take over steering. The system limits have been reached ⇒ *page 150, Steering intervention requests*.

 – Lane guidance is switched on but it is not active ⇒ *page 149, Lane guidance limitations*.

 /  – Take over steering. No steering detected or a system limit has been reached ⇒ *page 150, Steering intervention requests*.

WARNING

Observe the safety precautions and note the limits of the assist systems, sensors, and cameras ⇒ *page 127* to ⇒ *page 130*.

i Tips

- The sensor coverage area and the area view ⇒ *fig. 104* are schematic diagrams that do not display actual dimensions.
- Applies to: vehicles with area view: Objects approaching from behind will be depicted as vehicles, regardless of the actual object type.

Using adaptive cruise assist

Applies to: vehicles with adaptive cruise assist



Fig. 105 Lever: using adaptive cruise assist



Fig. 106 Operating lever: changing the speed

Switching on

- ▶ To switch on the adaptive cruise assist, pull the lever up to position ① until it engages.

Storing the speed and activating regulation

If you have switched the system on, you can set the current speed as the “regulated speed” and activate regulation:

- ▶ Press the **[SET]** button ②. The set speed is indicated with a marking in the speedometer ① ⇒ *page 145, fig. 103* and shown in the instrument cluster ⇒ .
- ▶ To save the speed while the vehicle is stationary, also hold the brake pedal down.

You can set any speed between 15 mph (20 km/h) and the maximum possible speed range ③ ⇒ *page 145, fig. 103*.

Pausing cruise control

The control can be stopped at any time:

- ▶ While driving or when the vehicle is stationary: Press the lever away from you in the direction of the arrow, or
- ▶ While driving: Press the brake pedal.

The indicator light turns off.

Resuming regulation

The previously set speed can be resumed at any time after a pause.

- ▶ To resume cruise control while driving, pull the lever toward you in the direction of the arrow.
- ▶ To resume cruise control when stationary, pull the lever toward you in the direction of the arrow while pressing the brake pedal.

Changing the speed

- ▶ To increase or decrease the set speed in smaller increments, briefly tap the lever toward or to the first level.
- ▶ To increase or decrease the set speed in larger increments, briefly tap the lever toward or to the second level.
- ▶ To increase or decrease the set speed continuously, hold the lever toward or until the marking in the speedometer ① ⇒ *page 145, fig. 103* has reached the desired speed.

Applies to: vehicles with predictive control: Predictive control can automatically adjust the set speed based on traffic and road conditions ⇒ *page 150*.

Preselecting a speed

You can also preselect the speed when adaptive cruise assist is not active by moving the lever in the desired direction /. Activate the previously selected speed by pulling the lever toward you in the direction of the arrow. ▶

Switching off

If you do not want to use the adaptive cruise assist for a longer period of time, you can switch it off.

- ▶ Push the lever away from you into position ① until it clicks into place.

The indicator light and the set speed will turn off.

WARNING

- Observe the safety precautions and note the limits of the assist systems, sensors, and cameras ⇒ *page 127* to ⇒ *page 130*.
- The adaptive cruise assist is only an assist system, and the driver is still responsible for vehicle operation. The driver is especially responsible for braking, steering, starting to drive, and controlling the speed and the distance from other vehicles.
- Turn on the adaptive cruise assist only if the surrounding conditions permit it. Always adapt your driving style to the current visual, weather, road, and traffic conditions.
- Switch the adaptive cruise assist off temporarily when driving in turning lanes or highway exits. This prevents the vehicle from accelerating to the stored speed when in these situations.
- If you press the **SET** button ② when driving at speeds below 15 mph (20 km/h), the minimum possible speed that the system can maintain will be set. If no vehicle is detected ahead of you, the vehicle will accelerate up to that speed.

Tips

- Always keep your hands on the steering wheel so you can be ready to steer at any time. The driver is always responsible for adhering to the regulations applicable in the country where the vehicle is being operated.
- If you switch the ignition or the adaptive cruise assist off, the stored speed is erased for safety reasons.

- When the adaptive cruise assist is switched on, the ESC and the ASR are switched on automatically.
- The system cannot be switched off or it may be interrupted if the road exceeds the maximum possible grade for safe operation.

Switching lane guidance on and off

Applies to: vehicles with adaptive cruise assist and lane guidance

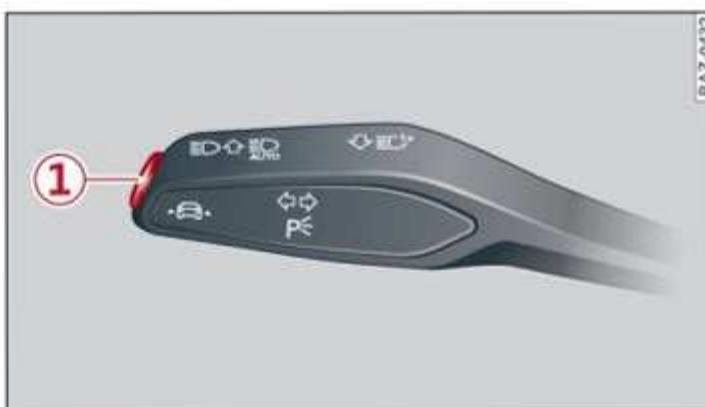

Fig. 107 Turn signal lever: button for lane guidance and lane departure warning

Within the limits of the system, lane guidance provides corrective steering to assist you with keeping the vehicle in the center of the lane as much as possible. This feature can be deactivated.

In a traffic jam, lane guidance also helps with leaving a space for emergency vehicles ¹⁾ by steering your vehicle as close to the edge of your lane as possible.

Switching lane guidance on and off

- ▶ You can turn the availability of lane guidance on or off under **Adaptive cruise assist** in the driver assistance menu ⇒ *page 131*, or
- ▶ Briefly press the ① button on the turn signal lever.

The availability of lane guidance is indicated by arrows ⑫ ⇒ *page 145*, *fig. 104* and indicator lights ⇒ *page 146* in the driver assistance display.

The system can assist you by providing corrective steering only when adaptive cruise assist is actively regulating and availability is switched on. ▶

¹⁾ In certain countries.

Lane guidance limitations

If  turns white, lane guidance is switched on but is not active. This may occur due to the following system limits or situations:

- The necessary lane marker lines have not been detected (for example, in a construction zone or because the lines are obstructed by snow, dirt, water, or lighting)
- The lane is too narrow or too wide
- The curve is too narrow
- Visibility is obstructed by a rise or dip.
- The turn signal was activated.
- The driver's hands are not on the steering wheel

Traffic jam assist with improved lane guidance

Applies to: vehicles with traffic jam assist

The  indicator light will be on when the traffic jam assist with improved lane guidance is active. A vehicle was detected ahead. The system controls the speed and distance from the vehicle driving ahead, and accelerates and brakes automatically. Traffic jam assist is available at speeds below 40 mph (60 km/h).

Messages

If  is displayed when there is a malfunction, the functions may be unavailable or limited.

A message that indicates the cause and possible solution may appear with some displays. The weather conditions may be too poor or a sensor may be covered. Clean the area in front of the sensors ⇒ *page 130* and try to turn on the systems again later.

If the malfunction remains, drive to an authorized Audi dealer or authorized Audi Service Facility immediately to have the malfunction corrected.

WARNING

Observe the safety precautions and note the limits of the assist systems, sensors, and cameras ⇒ *page 127* to ⇒ *page 130*.

Tips

- Always keep your hands on the steering wheel so you can be ready to steer at any time. The driver is always responsible for adhering to the regulations applicable in the country where the vehicle is being operated.
- Audi recommends only switching on lane guidance on well-constructed roads.

Driver intervention requests

Applies to: vehicles with adaptive cruise assist





Applies to: driver assistance display without area view
Fig. 108 Instrument cluster: brake intervention request





Applies to: driver assistance display with area view
Fig. 109 Instrument cluster: brake intervention request

Brake intervention request

If the  indicator light turns on and the message **Distance!**¹⁾ appears, press the brake pedal to slow down your vehicle ⇒ .



The braking effect by the adaptive cruise assist is not strong enough to maintain a sufficient distance to the vehicle driving ahead in this situation.

This view  will also appear if you have selected the driver assistance display in the trip computer ⇒ *page 18* or if you selected the  tab. ▶

¹⁾ Depending on the equipment

Steering intervention requests

If the  indicator light turns on, take over steering. The limits of the system have been reached, for example because the system's steering power is not sufficient in curves that are too narrow. The system will become inactive after a short time and will only become available again later.

If the  or  indicator lights turn on and a corresponding message appears, take over steering. Sufficient steering activity was not detected or a system limit has been reached. Keep your hands on the steering wheel so you can be ready to steer at any time. If you do not take over steering, adaptive cruise assist will be canceled. If the vehicle is equipped with emergency assist and it is ready to function, it will be activated
⇒ page 167.

WARNING

- Observe the safety precautions and note the limits of the assist systems, sensors, and cameras ⇒ page 127 to ⇒ page 130.
- The adaptive cruise assist is only an assist system, and the driver is still responsible for vehicle operation. The driver is especially responsible for braking, steering, and maintaining the distance to other vehicles.

Tips

- Always keep your hands on the steering wheel so you can be ready to steer at any time. The driver is always responsible for adhering to the regulations applicable in the country where the vehicle is being operated.
- The intervention requests may be accompanied by additional audio or visual signals, depending on the situation.

Predictive control

Applies to: vehicles with adaptive cruise assist and predictive control



Fig. 110 Instrument cluster: speedometer: predictive control display

General information

With predictive control, efficiency assist adapts the set speed in adaptive cruise control **1** based on detected speed limits and the upcoming route. Once the system no longer detects any incidents, adaptive cruise control will accelerate again to the last speed that you set. After switching the ignition on, a message appears when adaptive cruise assist is first activated to indicate if predictive control is available¹⁾.

Incident symbols indicate the situation to which predictive control is reacting ⇒ page 143, *Situation symbols*.

Requirements

- At least one predictive control function is turned on in the **Driver assistance** menu under **Adaptive cruise assist** ⇒ page 131.
- The adaptive cruise assist must be actively regulating ⇒ page 147.
- The system can only react to speed limits that are 15 mph (20 km/h) or higher.
- The map content of the navigation system* must be updated regularly in order for the system to work without restrictions ⇒ page 220.

Display in the speedometer

The display depends on vehicle equipment and is not available in all layouts*.

- 1** The marking shows the set speed (regulated speed that was set by you or by the predictive control).

¹⁾ Depending on the equipment

- ② The red band shows the difference between the speed limit and the set speed that is set.
- ③ The gray band shows if the vehicle speed is planned to drop below the set speed due to the road layout.

Overriding control

You can override the predictive control at any time by pressing the accelerator pedal. If the system changes the vehicle speed to adapt to speed limits, you can change the speed using the lever ⇒ *page 147, fig. 106*.

Setting predictive control

You can switch the predictive control on/off or adjust it to your preferences in the **Driver assistance** menu under **Adaptive cruise assist** ⇒ *page 131*. The settings depend on the vehicle equipment.

Set speed limit – adaptation to speed limits can be switched **On** or **Off**. Regulation **With tolerance** can also be selected, if desired. In this scenario, you may fall below or exceed the set speed in favor of increased efficiency.

Adjustment to curves along route – the adjustment to the route ahead can be switched **Off** or set individually from **Slow** to **Fast**. The setting influences vehicle handling with predictive control, for example the speed for driving through curves.

Messages

If  and a message with **Predictive control** is displayed when there is a malfunction, the functions are unavailable or limited.

A message that indicates the cause and possible solution may appear with some displays. The weather conditions may be too poor or a sensor may be covered. Clean the area in front of the sensors ⇒ *page 130* and try to turn on the systems again later.

If the malfunction remains, drive to an authorized Audi dealer or authorized Audi Service Facility immediately to have the malfunction corrected.

WARNING





- Observe the safety precautions and note the limits of the assist systems, sensors, and cameras ⇒ *page 127* to ⇒ *page 130*.
- Pay attention to traffic and the area around your vehicle when predictive control is switched on. The driver is always responsible for assessing the traffic situation.
- The system does not consider “right of way” rules and does not respond to traffic lights, so lack of driver attention in these situations can increase the risk of an accident.
- The speed when driving through curves may be different from what you as a driver would do or may not be suitable for the weather and road conditions. If necessary, apply the brakes and reduce the selected speed to be maintained in the **Adjustment to curves along route** setting to reduce the risk of an accident.

Tips

- Predictive control can exceed or drop below the maximum permitted speed. The driver is always responsible for adhering to the permitted speed limits.
- The traffic signs on the road always take priority over the display. The driver is always responsible for adhering to the regulations applicable in the country where the vehicle is being operated.
- If a speed limit is detected, the marking ① of the set speed limit will be adjusted even if the adaptive cruise assist is not actively regulating.
- Control by the system depends on which adaptive cruise assist driving program is set or on the selected Audi drive select* mode.
- After switching on the ignition and first driving onto a freeway or similar road without a speed limit, the system will regulate the speed to 80 mph (130 km/h)¹⁾. Then the system adjusts to the last speed set by the driver.

¹⁾ In certain countries.

- There is no adaptation to speed limits when driving through highway interchanges and when driving on or off the expressway.
- The system can fail to provide control or the control may be faulty if the values from the camera-based traffic sign recognition* are incorrect or the navigation system* map data is outdated.
- When route guidance is switched on, the system adapts to the route provided by the navigation system. Driving without route guidance or leaving a route can result in faulty control.

Symbol	Time distance	Distance at 62 mph (100 km/h)
	Approximately 1 second	92 feet (28 m)
	Approximately 1.3 seconds	118 feet (36 m)
	Approximately 1.8 seconds (the setting corresponds to a distance that is "half of the vehicle speed")	164 feet (50 m)
	Approximately 2.4 seconds	219 feet (67 m)
	Approximately 3.6 seconds	328 feet (100 m)

Setting the distance

Applies to: vehicles with adaptive cruise assist

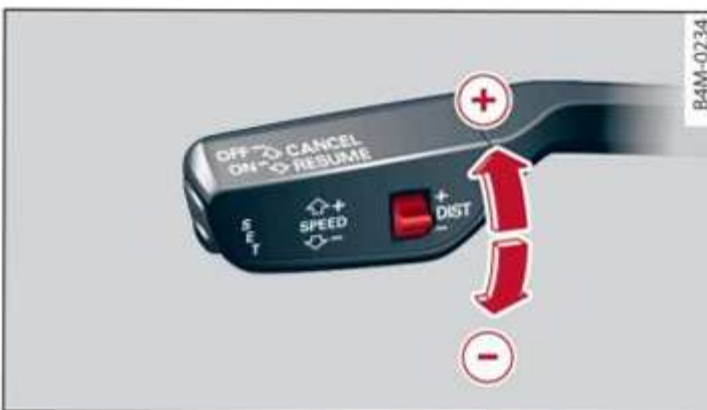



Fig. 111 Operating lever: setting the distance

⚠ WARNING
 Observe the safety precautions and note the limits of the assist systems, sensors, and cameras ⇒ page 127 to ⇒ page 130.

i Tips

- When setting the distance, the driver is responsible for adhering to any applicable legal regulations.
- In the driver assistance display, a graphic view is shown instead of the indicator lights. The display matches the functions of the indicator lights.
- Depending on the selected driving program and distance, driving behavior when accelerating may vary from moderate to sporty ⇒ page 155, *Adjusting the adaptive cruise assist*.
- The distances provided are specified values. Depending on the driving situation and how the vehicle ahead is driving, the actual distance may be more or less than these target distances.

When approaching a vehicle driving ahead, the adaptive cruise assist brakes to the set speed and then maintains the set distance. If the vehicle driving ahead accelerates, then the adaptive cruise assist will also accelerate up to the speed that you have set.

- ▶ Tap the rocker switch to display the distance that is currently set.
- ▶ To increase or decrease the distance in increments, tap the switch again toward  or .

The newly-set distance will be shown briefly, for example with the  indicator light.

If you adjust the speed, you must also change the time gap to the vehicle driving ahead. The higher the speed, the greater the distance that is needed. The following distances can be set:

Additional functions

Applies to: vehicles with adaptive cruise assist

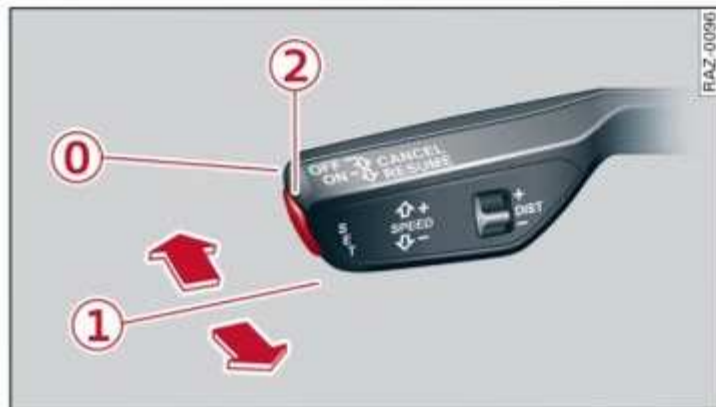

Fig. 112 Lever: using adaptive cruise assist

Requirement: all additional functions require adaptive cruise assist control to be active.

Overriding control

You can override control by the system completely, for example if you would like to pass another vehicle or if you would like to accelerate faster.

- ▶ To accelerate manually, pull the lever toward you in the direction of the arrow and hold it there, or press the accelerator pedal.
- ▶ To resume the usual cruise control, release the lever or remove your foot from the accelerator pedal.

When the driver assistance display is open, the message **Overridden** will appear.

Decreasing the distance

You can temporarily decrease the distance even more, for example if you would like to merge into another lane because of lane closures. In this situation, the adaptive cruise assist will accelerate above the set speed if necessary.

- ▶ To further reduce the distance to the vehicle ahead temporarily, pull the lever toward yourself in the direction of the arrow and hold it in that position.
- ▶ To resume the system control, release the lever.

When the driver assistance display is open, the message **Overridden** will appear.

Behavior when a turn signal is active (for merging)¹⁾²⁾

When you use the turn signal, for example when merging, then the system extends its area of control into the adjacent lane. When the function is active, the adaptive cruise assist will reduce the speed so that you can merge behind the next vehicle more easily ⇒ ⚠.

Requirements: the system is activated and has detected that you are driving on a highway, the difference in speed compared to other vehicles is sufficiently small, and the distance between the vehicles is great enough. The vehicles are driving in traffic that is flowing consistently.

- ▶ To activate the function, activate the turn signal in the direction of the lane in which you would like to merge.
- ▶ To cancel the function after a short period of time, switch the turn signal off again. System control will be canceled immediately if you press the accelerator pedal.

The system will continue to maintain distance to the vehicle ahead in your own lane, within the limits of the system.

⚠ WARNING

- Observe the safety precautions and note the limits of the assist systems, sensors, and cameras ⇒ *page 127* to ⇒ *page 130*.
- Resting your foot on the accelerator pedal could override the cruise control. Braking interventions and corrective actions by the system may not occur.
- The functions only provide assistance. The driver is still responsible for controlling the vehicle when using these functions. The driver is especially responsible for changing lanes, applying the brakes, controlling the

¹⁾ This is not available in some countries.

²⁾ The function or equipment that is described was in development at the time this manual was published and may not be available in your vehicle.

speed, and maintaining the distance to other vehicles.

Driving in stop-and-go traffic

Applies to: vehicles with adaptive cruise assist



Applies to: driver assistance display without area view
Fig. 113 Instrument cluster: safe start monitor



Applies to: driver assistance display with area view
Fig. 114 Instrument cluster: safe start monitor

Stopping with adaptive cruise assist

The adaptive cruise assist also assists you in stop-and-go traffic. Within the limits of the system, your vehicle may brake and remain at a stop if a vehicle driving ahead stops.

Starting to drive with adaptive cruise assist¹⁾

As long as the ready to drive message is displayed, your vehicle will begin driving automatically when the vehicle ahead starts to move ⇒ .

The touching of the steering wheel will be evaluated in stop-and-go traffic. As long as at least one hand is detected on the steering wheel, the driver will be considered ready for driving and the ready to drive status can be extended.

If your vehicle is stopped for too long, it will no longer drive autonomously for safety reasons, and the message will turn off.

- ▶ To extend ready to drive status for a brief time or to reactivate it, pull the lever briefly toward you in the direction of the arrow ⇒ *page 153, fig. 112.*
- ▶ To resume control of the vehicle immediately, tap the accelerator pedal.

Safe start monitor

The vehicle can still start to drive even if certain obstacles are detected when starting to drive ⇒ . If the surrounding area detection detects an obstacle, you will be alerted to the danger by the indicator light.

If the driver assistance display is open, the view ⇒ *fig. 113* and the message **Warning!** will also appear. An audio signal will sound as well. Your vehicle will drive more slowly when starting. This may also occur in some situations when there is no apparent obstacle.

- ▶ Press the brake pedal to slow your vehicle if necessary.

WARNING

- Observe the safety precautions and note the limits of the assist systems, sensors, and cameras ⇒ *page 127* to ⇒ *page 130.*
- As long as the ready to drive message¹⁾ is displayed, your vehicle will start driving even if there is an obstacle between your vehicle and the vehicle ahead. To reduce the risk of an accident, always make sure there are no obstacles between your vehicle and the vehicle driving ahead.

Tips

For safety reasons, adaptive cruise assist only starts driving actively if:

- The driver's safety belt is fastened,
- All doors and the hood are closed
- The vehicle has not been stationary for a long period of time

¹⁾ This is not available in some countries.

Adjusting the adaptive cruise assist

Applies to: vehicles with adaptive cruise assist

You can adjust the adaptive cruise assist to your preferences in the **Driver assistance** menu ⇒ *page 131*. The settings depend on the vehicle equipment.

Possible settings:

Lane guidance – If lane guidance is also active when adaptive cruise assist control is active, you can switch it on or off.

Driving program – Depending on the driving program and the distance that are set, the vehicle handling will be adjusted from **Sport** to **Comfort** and the lane guidance haptic feedback will be adjusted.

Store last distance - The last distance that was set will be stored after the ignition is switched off. If the distance is not stored, distance  (time distance of approximately 1.8 seconds) is automatically preset every time the ignition is switched on.



Messages

Applies to: vehicles with adaptive cruise assist



Applies to: driver assistance display with area view

Fig. 115 Instrument cluster: narrow area



If  or  is displayed when there is a malfunction, the adaptive cruise assist functions or traffic jam assist* functions may be unavailable or limited.

A message that indicates the cause and possible solution may appear with some displays. The weather conditions may be too poor or a sensor may be covered. Clean the area in front of the sensors ⇒ *page 130* and try to turn on the systems again later.

If the malfunction remains, drive to an authorized Audi dealer or authorized Audi Service Facility immediately to have the malfunction corrected.

The following messages may appear depending on the vehicle equipment:

Narrow area

Depending on vehicle equipment, this message will appear in the driver assistance display if the adaptive cruise assist is adjusting the speed in a narrow area, for example in a construction zone. The display  will only appear in vehicles equipped with area view and if the  tab has been selected in the instrument cluster.

Adaptive cruise assist: Please take over!

Adaptive cruise assist was ended, for example because the vehicle rolled backwards when starting on a slight incline even though the system was active. You must take over further control of the vehicle.

Adaptive cruise assist: limited availability. See owner's manual

This message appears when the sensor view is limited, for example, when weather conditions are too poor or a sensor is covered. You can switch on the adaptive cruise assist, but certain functions such as assistance in narrow areas will not be available. Under certain circumstances, some objects may be detected late or may not be detected at all. Be especially careful. Cleaning the area in front of the sensors ⇒ *page 130* may correct the malfunction.

Distance warning

Description

Applies to: vehicles with distance warning

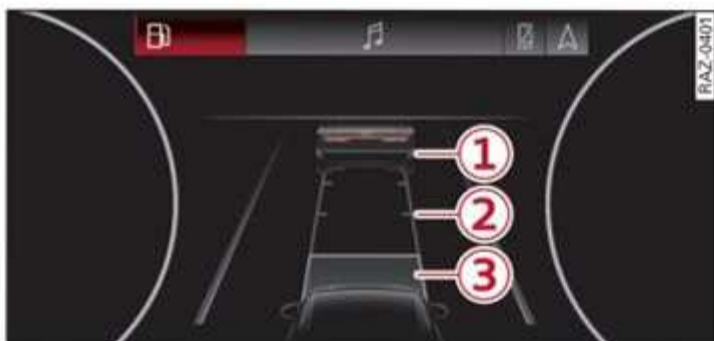

Applies to: vehicles with adaptive cruise assist and without area view

Fig. 116 Instrument cluster: display of the current distance

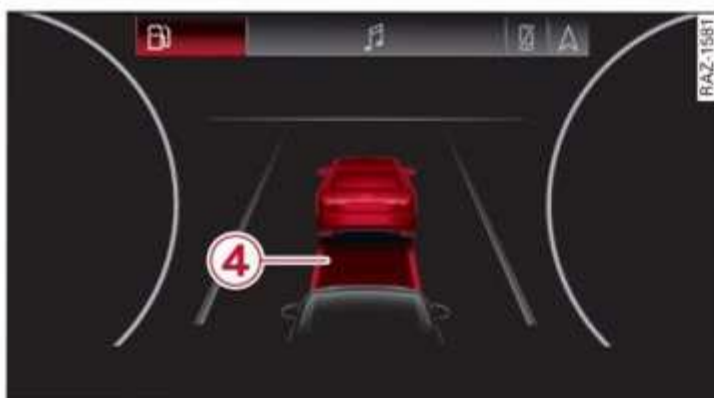

Applies to: vehicles with adaptive cruise assist:

Fig. 117 Instrument cluster: distance warning with or without area view

General information

At speeds above approximately 40 mph (65 km/h), this function measures the distance to the vehicle ahead as a time interval, as long as the adaptive cruise assist is not actively regulating. If the distance falls below the warning threshold and remains there, the system will warn you of the hazard with the  indicator light.

View in the driver assistance display

Applies to: vehicles with adaptive cruise assist

This view will only appear if you have selected the driver assistance display in the trip computer \Rightarrow [page 18](#) or if you selected the  tab.

- ① Driver assistance display without area view: vehicle driving ahead detected
- ② Driver assistance display without area view: you can estimate the distance to an obstacle with the help of the markings. Each marking represents approximately one second.
- ③ Driver assistance display without area view: set warning threshold. Depending on the settings, the display will be colored in from the bottom to the top.
- ④ The actual distance is smaller than the set distance and you will be informed about the danger.



Adjusting the distance warning

You can turn the distance warning on or off in the **Driver assistance** menu, or adjust it to your preferences \Rightarrow [page 131](#). The settings depend on the vehicle equipment.

Possible settings:

– Warning threshold

Messages

If  or  is displayed when there is a malfunction, the distance warning functions may be unavailable or may be limited.

A message that indicates the cause and possible solution may appear with some displays. The weather conditions may be too poor or a sensor may be covered. Clean the area in front of the sensors \Rightarrow [page 130](#) and try to turn the system on again later.

If the malfunction remains, drive to an authorized Audi dealer or authorized Audi Service Facility immediately to have the malfunction corrected.

WARNING

Observe the safety precautions and note the limits of the assist systems, sensors, and cameras \Rightarrow [page 127](#) to \Rightarrow [page 130](#).

i Tips

- The driver is always responsible for adhering to the regulations applicable in the country where the vehicle is being operated.
- You may fall below the warning threshold briefly when passing or when quickly approaching a vehicle driving ahead. There is no warning in this scenario. A warning is given only if you fall below the warning threshold for an extended period of time.

Lane departure warning

General information

Applies to: vehicles with lane departure warning

The lane departure warning can detect lane marker lines within the limits of the system. If you are approaching a detected lane marker and it appears likely that you will leave the lane, the system can warn you with corrective steering and a steering wheel vibration, if necessary.

The system functions in the speed range of approximately 40 mph - 155 mph (65 km/h - 250 km/h).

! WARNING

Observe the safety precautions and note the limits of the assist systems, sensors, and cameras ⇒ page 127 to ⇒ page 130.

Description

Applies to: vehicles with lane departure warning

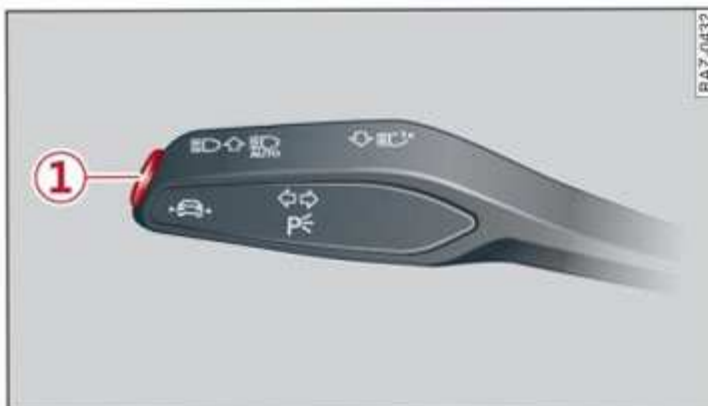

Fig. 118 Turn signal lever: button for lane departure warning and lane guidance for adaptive cruise assist*



Applies to: driver assistance display without area view
Fig. 119 Instrument cluster: lane departure warning

Switching the lane departure warning on and off

- ▶ You can turn the lane departure warning on or off in the **Driver assistance** menu ⇒ page 131, or
- ▶ Press and hold the button ① on the turn signal lever until the applicable indicator light in the instrument cluster turns off or on.





If you switch the system off, the indicator light will turn on and a corresponding message will appear.

Display and warning

The availability, readiness to provide warnings, and the warnings are indicated with indicator lights.

The lane departure warning is ready to provide warnings if an object is detected on at least one side of the individual lane.

Driver assistance display ^{a)}	Indicator lights	Meaning
② White line(s)	on the corresponding side	the lane departure warning is switched on but not ready to provide warnings.
③ Green line(s)	on the corresponding side	The lane departure warning is switched on and ready to provide warnings.

Driver assistance display ^{a)}	Indicator lights	Meaning
 Red line	 on the corresponding side	The lane departure warning system will warn you with a corrective steering intervention before exiting the lane.
Red lines on both sides	  on both sides	Lane guidance by the emergency assist* is active ⇒ <i>page 167</i> .

^{a)} Applies to: driving assistance display with area view: Only the red lines will be displayed in the driving assistance display.

If the lane departure warning must intervene for a long period of time, a message will request you to drive in the center of the lane. The steering wheel can also vibrate to warn you if lane boundaries are detected during a passing maneuver. You can turn the steering wheel vibrations on or off in the **Driver assistance** menu ⇒ *page 131*. The settings depend on the vehicle equipment.

If the  indicator light turns on, the lane departure warning is not ready to provide warnings. This may occur due to the following system limits or situations:

- The necessary lane marker lines have not been detected (for example, in a construction zone or because the lines are obstructed by snow, dirt, water, or lighting)
- The speed is below the activation speed
- The lane is too narrow or too wide
- The curve is too narrow
- Visibility is obstructed by a rise or dip.
- The driver's hands are not on the steering wheel
- The turn signal was activated.

Steering intervention request

If the lane departure warning intervenes multiple times when no steering activity is detected, the steering intervention request will provide a warning using audio and visual signals, such as . Take over the steering and keep your hands on the steering wheel so that you will be ready to

steer at any time. The system may no longer be ready to provide warnings after a short time, and it will only become active again later.

If you do not take over steering, the lane departure warning will no longer be ready to provide warnings. If the vehicle is equipped with emergency assist and it is ready to function, it will be activated ⇒ *page 167*.

Behavior when a turn signal is active

Applies to: vehicles without side assist: The system will not warn you if you activate a turn signal before crossing the lane marker line. In this case, it assumes that you are changing lanes intentionally.

Applies to: vehicles with side assist: If the turn signal is activated, the lane departure warning is ready, and a lane change has been classified as critical by the lane departure warning due to vehicles traveling beside you or due to approaching vehicles, then a noticeable corrective steering movement will occur shortly before exiting the lane. This will attempt to keep your vehicle in the lane.

WARNING

- Observe the safety precautions and note the limits of the assist systems, sensors, and cameras ⇒ *page 127* to ⇒ *page 130*.
- The system uses corrective steering to warn that the vehicle is leaving the lane. The driver is always responsible for keeping the vehicle in the driving lane.
- Corrective steering may not occur at all in certain situations, such as during heavy braking. Always be ready to intervene.



Tips

- Always keep your hands on the steering wheel so you can be ready to steer at any time. The driver is always responsible for adhering to the regulations applicable in the country where the vehicle is being operated.
- The system does not provide any corrective steering or steering wheel vibrations if it detects that you are passing another vehicle. ▶

- This view in the driver assistance display will only appear if you selected it in the trip computer ⇒ *page 18* or if you selected the  tab.

Messages

Applies to: vehicles with lane departure warning

If  or  is displayed when there is a malfunction, the lane departure warning and lane guidance functions of the adaptive cruise functions may be unavailable or limited.

A message that indicates the cause and possible solution may appear with some displays. The weather conditions may be too poor or the camera may be covered. Clean the area in front of the camera ⇒ *page 130* and try to turn on the systems again later.

If the malfunction remains, drive to an authorized Audi dealer or authorized Audi Service Facility immediately to have the malfunction corrected.

Audi pre sense

Function overview

Applies to: vehicles with Audi pre sense

Within the limits of the system, the Audi pre sense functions can initiate measures in certain driving situations to protect the vehicle occupants and other road users. Depending on the vehicle equipment, various Audi pre sense systems may be installed:

- **Audi pre sense basic** can react during emergency and dangerous braking maneuvers and unstable driving situations (such as oversteering or understeering).
- **Audi pre sense front** can detect an impending frontal impact and react with warnings, braking interventions, and preemptive safety measures for the vehicle occupants.
- **Audi pre sense rear** monitors the rear traffic behind your vehicle and can react to an impending rear impact.
- **Audi pre sense side** can detect an impending side impact from cross-traffic and vehicles com-

ing from the side, and can initiate preemptive safety measures.

- The **swerve assist** can help you to steer the vehicle around an obstacle during an evasive maneuver that is detected as critical.
- The **turn assist** can detect vehicles in the opposite lane as critical during a turning maneuver and react with braking maneuvers.

Audi pre sense preemptive safety measures

Applies to: vehicles with Audi pre sense

Depending on the vehicle speed and the vehicle equipment, the following functions may be initiated in certain situations:

- Visual and audio warnings
- Reversible tensioning of safety belts
- Closing the windows and panoramic glass roof
- Adjusting the seats
- Other preemptive safety measures by individual systems



WARNING

Observe the safety precautions and note the limits of the assist systems, sensors, and cameras ⇒ *page 127* to ⇒ *page 130*.



Tips

- Depending on the risk situation that is detected and the selected Audi drive select* mode, not all preemptive safety measures may be initiated under certain circumstances. Certain functions can be adjusted or skipped if necessary.
- Audi pre sense may be restricted or unavailable under certain circumstances, for example if:
 - If there are persons in the vehicle who are not using a safety belt.
 - After turning on the ignition, as long as the  indicator light is on.
 - When driving in reverse.
 - There is an airbag control module malfunction
 - System functions may not be available if the ESC is limited or switched off, or if there is a malfunction.

Audi pre sense basic

Applies to: vehicles with Audi pre sense basic

Audi pre sense basic is automatically active at speeds of approximately 20 mph (30 km/h) and higher. Audi pre sense basic can trigger preemptive safety measures during emergency braking and dangerous braking maneuvers as well as in unstable driving situations, such as oversteering or understeering ⇒ *page 159, Audi pre sense preemptive safety measures.*

The message **Audi pre sense**  will warn you about the danger.

WARNING

Observe the safety precautions and note the limits of the assist systems, sensors, and cameras ⇒ *page 127 to ⇒ page 130.*

Audi pre sense front

Applies to: vehicles with Audi pre sense front

Within the limits of the system, Audi pre sense front can warn about an impending front end collision and brake the vehicle strongly, if necessary. The system uses the camera behind the windshield and is available at speeds above approximately 6 mph (10 km/h).

Driving situations

The situations to which the system reacts depends on the vehicle speed.

Up to speeds of approximately 52 mph (85 km/h), the system may react to the following situations:

- Pedestrians and cyclists in your lane

Up to speeds of approximately 155 mph (250 km/h), the system may react to the following situations:

- A vehicle driving ahead clearly applies the brakes
- When approaching a vehicle ahead that is clearly traveling more slowly
- When approaching a stationary vehicle

Prewarning

To warn about detected dangers, **Audi pre sense**  will appear in the instrument cluster and an audio signal will sound.

A brief application of the brakes

If a collision is imminent, there may be an acute warning using a brief application of the brakes. You will also be warned about the danger by an indicator in the instrument cluster display. You may only be able to avoid a collision by swerving or braking strongly.

Automatic braking force increase

If there is an impending collision and you are not applying the brakes enough, the braking force may be increased, depending on the situation.

Automatic braking

If you do not react to the acute warning, the system may apply the brakes with strong braking force within the limits of the system in order to reduce the speed of impact in the event of a collision.

If the brakes were applied until the vehicle stopped, **Please take over!**  will appear in the instrument cluster and you must take over control of the vehicle.

WARNING

- Observe the safety precautions and note the limits of the assist systems, sensors, and cameras ⇒ *page 127 to ⇒ page 130.*
- Audi pre sense front cannot overcome natural physical laws. It is a system designed to assist and it cannot prevent a collision in every circumstance. The driver must always intervene. The driver is always responsible for braking in a timely manner. Do not let the increased safety provided tempt you into taking risks. This could increase your risk of a collision.
- Audi pre sense front does not react to certain objects, such as animals, crossing or oncoming vehicles, bars, railings, or railcars.
- Audi pre sense front may be limited or unavailable when driving in curves.

- Loose objects can be thrown around the vehicle interior during sudden driving or braking maneuvers, which increases the risk of an accident. Store objects securely while driving.
- Make sure that each person in the vehicle has their safety belt fastened correctly and follows the instructions for proper seating ⇒ *page 67*.

Audi pre sense rear

Applies to: vehicles with Audi pre sense rear

Within the limits of the system, Audi pre sense rear uses data from radar sensors at the rear corners of the vehicle and calculates the probability of a rear-end collision with the vehicle behind you.

Audi pre sense preemptive safety measures can be initiated if the risk of a collision with the vehicle behind you is detected.

WARNING

- Observe the safety precautions and note the limits of the assist systems, sensors, and cameras ⇒ *page 127* to ⇒ *page 130*.
- Audi pre sense rear does not react to pedestrians, animals, crossing objects, and objects not detected as vehicles.

Tips

Audi pre sense rear functions may also switch off if there is a malfunction in the side assist system.

Audi pre sense side

Applies to: vehicles with Audi pre sense side

Within the limits of the system, Audi pre sense can warn about impending collisions with cross-traffic and vehicles approaching from the side, and trigger Audi pre sense preemptive safety measures.

The system uses additional sensors in the front and rear areas and is active at speeds up to approximately 35 mph (60 km/h).

Depending on the situation, the suspension may be lifted* on the side facing the accident.

WARNING

- Observe the safety precautions and note the limits of the assist systems, sensors, and cameras ⇒ *page 127* to ⇒ *page 130*.
- Audi pre sense side does not react to pedestrians, animals, and objects not detected as vehicles.

Tips

- The suspension lift* only occurs when the ignition is switched on, the doors and luggage compartment lid are closed, and if the vehicle has been driven faster than 3 mph (5 km/h) at least once since the ignition was switched on.
- The Audi pre sense side functions may also switch off if there is a malfunction in the intersection assistant*.

Swerve assist

Applies to: vehicles with swerve assist

The swerve assist can help you to steer the vehicle around an obstacle detected in a critical area. If you avoid an obstacle after the acute warning, then swerve assist assists you by specifically braking individual wheels and applying slight steering adjustment to correct the steering wheel angle as long as you are actively steering. The swerve assist is available at speeds between approximately 30 mph and 90 mph (50 km/h - 150 km/h).

WARNING

- Observe the safety precautions and note the limits of the assist systems, sensors, and cameras ⇒ *page 127* to ⇒ *page 130*.
- Swerve assist does not react to pedestrians, animals, crossing objects, and objects not detected as vehicles.

Tips

- System functions may not be available if the ESC is limited or switched off, or if there is a malfunction.

- An indicator in the instrument cluster will inform you when there is an intervention.

Turn assist

Applies to: vehicles with turn assist

When turning left, turn assist can help to reduce the risk of a collision with an oncoming vehicle by using braking action to keep your vehicle in its lane. The function is only available when the turn signal is turned on and at speeds up to maximum of 6 mph (10 km/h).

WARNING

- Observe the safety precautions and note the limits of the assist systems, sensors, and cameras ⇒ *page 127* to ⇒ *page 130*.
- The turn assist does not react to pedestrians, animals, crossing objects, and objects not detected as vehicles.

Tips

- System functions may not be available if the ESC is limited or switched off, or if there is a malfunction.
- An indicator in the instrument cluster will inform you when there is an intervention.

Adjusting Audi pre sense

Applies to: vehicles with Audi pre sense

You can switch Audi pre sense and the associated systems on or off in the **Driver assistance** menu, or adjust them individually ⇒ *page 131*. The systems may only be switched on/off or adjusted while the vehicle is stationary.

Possible settings:

Setting the prewarning

You can adjust the warning time for the prewarning to your preference (**Early/Medium/Late**) or switch the prewarning off.

Set the warning time for the early warning to **Early** at first. If you feel that the prewarnings appear too early, then set the warning time to **Medium**. The **Late** warning time should only be set in special circumstances.

Tips

- If the system is switched off, it will switch on again automatically once the ignition is switched on again.
- Switch Audi pre sense off when you are not using public streets, when loading the vehicle onto a vehicle carrier, train, ship, or other type of transportation, or when towing the vehicle. This can help to prevent an undesired intervention from the Audi pre sense system.

Messages

Applies to: vehicles with Audi pre sense

If  is displayed when there is a malfunction, the Audi pre sense functions may be unavailable or may be limited.

A message that indicates the cause and possible solution may appear with some displays. The weather conditions may be too poor or a sensor may be covered. Bring the vehicle to a full stop, switch the ignition off, and clean the area in front of the sensors ⇒ *page 130*.

If the message still appears after switching the ignition on again, have an authorized repair facility correct the malfunction as soon as possible.

Side assist

Description

Applies to: vehicles with side assist

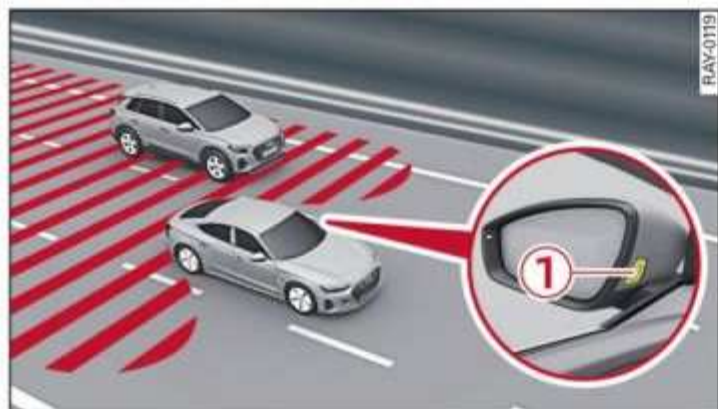

Fig. 120 Driving situations and displays in the exterior mirror



Applies to: driver assistance display with area view
Fig. 121 Instrument cluster: side assist display

General information

Side assist monitors the blind spot and traffic behind your vehicle in the adjacent lanes and provides assistance when you are changing lanes and when turning¹⁾. If the system detects an object approaching and classifies it as critical, the display in the exterior mirror ① on that side of the vehicle will turn on,

Driving situations

The side assist warning is active at speeds that are approximately equal to walking speed, and can help in situations such as the following:

- Your vehicle is being passed. The faster another vehicle approaches from behind, the sooner the display in the exterior mirror will turn on.
- There are vehicles traveling in the same direction as you in a lane adjacent to yours. The display in the exterior mirror will turn on when the

detected object is in the “blind spot”, at the latest.

- You are slowly passing another vehicle. If the difference in speed between the two vehicles is less than 9 mph (15 km/h), the display in the exterior mirror will turn on.
- You are turning at low speeds¹⁾.

Information stage

If you still have not activated a turn signal, the system will inform you about objects classified as critical at speeds above approximately 6 mph (10 km/h).

This is even possible when your vehicle is stationary and the turn signal is turned on¹⁾, so that the system can also assist you when turning.

The system informs you about objects classified as critical by turning on the display in the exterior mirror on that side of the vehicle ①.

The display remains dim in the information stage so that you are not distracted while looking forward.

Warning stage

Once you activate a turn signal, the system will inform you about objects classified as critical by turning on the display in the respective exterior mirror.

If other driver assistance systems (depending on vehicle equipment) detect that your vehicle is about to leave the lane, the display will blink even if the turn signal lever is not activated to warn you about objects that are classified as critical. You can also be warned with corrective steering ⇒ *page 157, Lane departure warning*.

Display in the instrument cluster

Applies to: driver assistance display with area view

Side assist (information and warning level) will be displayed in the instrument cluster ②, in addition to the display in the outside mirror. The display ⇒ *fig. 121* will only appear if the  tab has been selected in the instrument cluster. ▶

¹⁾ This function is not available in every vehicle.

System limitations

The system uses the data from the radar sensors at the rear corners of the vehicle \Rightarrow page 130, fig. 95. They are designed to detect the left and right adjacent lanes when the road lanes are the normal width. In some situations, the system may react to vehicles in your own lane or lanes that are not directly adjacent to yours, or to objects on the side of the road. In this case, the display will turn on even though there is no vehicle in the critical area. These situations may include:

- Driving on the edge of your own lane
- Narrow lanes
- Curves
- High barriers on the side of the road

WARNING

- Observe the safety precautions and note the limits of the assist systems, sensors, and cameras \Rightarrow page 127 to \Rightarrow page 130.
- The display may not appear at all or it may not appear on time when vehicles are approaching or being passed very quickly.

Tips

- If the window glass in the driver's door or front passenger's door has been tinted, the display in the exterior mirror may be incorrect.
- The coverage areas of the sensors \Rightarrow fig. 120 are diagrams and do not represent a true-to-scale image of the sensor ranges.
- The system complies with United States FCC regulations and ISED regulations \Rightarrow page 325.

Adjusting side assist

Applies to: vehicles with side assist

You can turn the side assist on or off in the **Driver assistance** menu, or adjust it to your preferences \Rightarrow page 131. The settings depend on the vehicle equipment.

Possible settings:

Brightness – Change the brightness only when side assist is switched on, so that the selected



setting can be checked in the exterior mirror displays. Adjust the brightness to a level where the display in the information stage will not disrupt your view ahead. Because the display brightness automatically adapts to the ambient light, it may have already been adjusted to the highest or lowest setting during the automatic adaptation.

Tips

- If the system is activated, the displays will turn on briefly when the ignition is switched on.
- Applies to: driver assistance display with area view: The display in the instrument cluster will remain active even if side assist is switched off.

Messages

Applies to: vehicles with side assist

If  or  is displayed when there is a malfunction, the side assist and exit warning system functions may be unavailable or may be limited.

A message that indicates the cause and possible solution may appear with some displays. The weather conditions may be too poor or a sensor may be covered. Clean the sensor area at the rear corners of the vehicle \Rightarrow page 130, fig. 95 and try to turn the systems on again later.

If the malfunction remains, drive to an authorized Audi dealer or authorized Audi Service Facility immediately to have the malfunction corrected.

Exit warning

Description

Applies to: vehicles with exit warning system

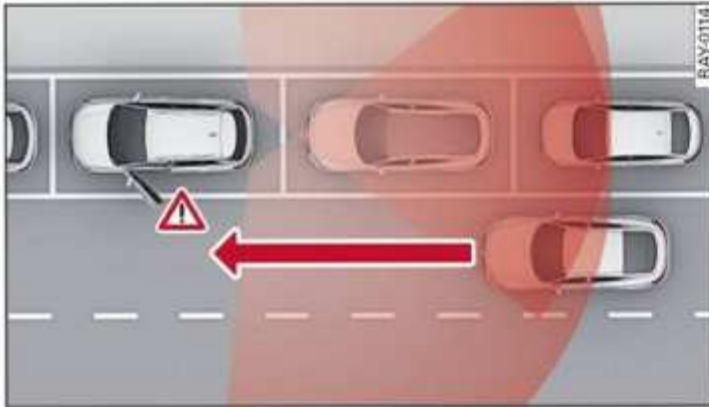

Fig. 122 Approaching traffic detected



Fig. 123 Front door: warning strip

General information

Within system limits, the exit warning system can detect traffic approaching from behind such as vehicles, and provide assistance based on this information when you are exiting the vehicle ⇒ *fig. 122*. The system uses the data from the radar sensors at the rear corners of the vehicle.

Displays and warnings

If you pull a door handle while the vehicle is stationary and an object classified as critical is approaching, the warning strip ① and the display on the exterior mirror ② will light up on the corresponding side of the vehicle. The opening of the door will also be slowed briefly.

If the door is opened, the displays on that side will flash. If another road user that is classified as critical is approaching while a door is already open, the displays on that door will turn on.

The same messages apply for the exit warning system and side assist ⇒ *page 164*.

Switching the exit warning on and off

- You can turn the exit warning on or off in the **Driver assistance** menu ⇒ *page 131*.

! WARNING

- Observe the safety precautions and note the limits of the assist systems, sensors, and cameras ⇒ *page 127* to ⇒ *page 130*.
- Always pay attention to traffic and to the area around your vehicle. The exit warning system does not replace the attention of the vehicle occupants. The vehicle occupants are always responsible for opening the doors and exiting the vehicle.
- The exit warning system does not respond to people and cannot warn you about every type of approaching object, such as cyclists. Always monitor the traffic situation as well as the vehicle's surroundings with direct eye contact.
- The display may not appear in time when vehicles are approaching very quickly.
- The exit warning system does not react to stationary objects or pedestrians.
- The exit warning system will not provide alerts if your vehicle is pulled too far into the parking space so that it is hidden by adjacent vehicles.

i Tips

- The exit warning system can be available for up to approximately three minutes after unlocking the vehicle and opening the door as well as after switching off the ignition. Then the displays flash briefly and the system switches off.
- The coverage areas of the sensors ⇒ *fig. 122* are diagrams and do not represent a true-to-scale image of the sensor ranges.
- The system complies with United States FCC regulations and ISED regulations ⇒ *page 325*.

Intersection assistant

Description

Applies to: vehicles with intersection assistant



Fig. 124 Detected cross-traffic



Fig. 125 Instrument cluster: intersection assistant direction display with or without area view

General information

The **intersection assistant** can warn about approaching cross traffic in complex intersections ⇒ *fig. 124*.

The system monitors intersections and exit ramps using the sensors installed in the vehicle that detect the front and side areas around the vehicle. Moving objects that are approaching from behind, such as cars, are detected within the limits of the system ⇒ . In intersections and exit ramps with poor visibility, the system

can also warn about a potential collision with approaching cross traffic that is detected.

Requirements for using the intersection assistant:

- The speed must not be higher than approximately 18 mph (30 km/h).
- The “D” selector lever position is selected.

Displays, warnings, and braking

- **Display:** the red arrow can indicate the direction from which the cross traffic is approaching. The indicator in the upper display only appears when the parking aid is activated. For vehicles with peripheral cameras only in the **Front** and **Front corner** camera views. The display in the instrument cluster ⇒ *fig. 125* only appears if you have opened the driver assistance display in the trip computer ⇒ *page 18*. Depending on the equipment, the driver assistance display with area view will only appear if the tab has been selected in the instrument cluster.
- **Warnings:** the message **Cross traffic!** can warn about critical cross-traffic when driving forward. There may also be an audible signal.
- **Automatic brake activation:** if you do not react to a warning, a brief braking by the system can warn you of a potential collision with an approaching object when driving forward at speeds up to approximately 6 mph (10 km/h).

Switching the intersection assistant on and off

- You can turn the intersection assistant on or off in the **Driver assistance** menu ⇒ *page 131*.

Messages

If or is displayed when there is a malfunction, the intersection assistant functions may be unavailable or may be limited.

A message that indicates the cause and possible solution may appear with some displays. The weather conditions may be too poor or a sensor may be covered. Clean the area in front of the sensors ⇒ *page 130* and try to turn the system on again later. ▶

If the malfunction remains, drive to an authorized Audi dealer or authorized Audi Service Facility immediately to have the malfunction corrected.

WARNING

- Observe the safety precautions and note the limits of the assist systems, sensors, and cameras ⇒ *page 127* to ⇒ *page 130*.
- The intersection assistant will not provide alerts about people and cannot warn you about every type of approaching objects, such as cyclists. Always monitor the traffic situation as well as the vehicle's surroundings with direct eye contact.
- The system may not react at all or it may not react on time when vehicles are approaching very quickly.

Tips

- The coverage areas of the sensors ⇒ *fig. 124* are diagrams and do not represent a true-to-scale image of the sensor ranges.
- The system complies with United States FCC regulations and ISED regulations ⇒ *page 325*.

Emergency assist

Description

Applies to: vehicles with emergency assist

Introduction

Within the limits of the system, emergency assist can detect inactivity from the driver. In these instances, the system will give a warning, assume control of the vehicle if necessary, and automatically bring the vehicle to a stop in the lane.

Availability of the emergency assist

The availability of emergency assist depends on whether you are driving with steering assist systems or manually, and if the emergency assist is switched on or off in the **Driver assistance** menu:

- ① You are driving with the adaptive cruise assist lane guidance function activated.
- ② You are driving with the lane departure warning.
- ③ You are driving manually without steering assist systems.

Driving situation	Availability if the emergency assist is:	
	Switched on	Switched off
①	At approximately 6 mph (10 km/h) and above	At approximately 6 mph (10 km/h) and above
②	from approx. 40 mph (65 km/h)	from approx. 40 mph (65 km/h)
③	from approx. 40 mph (65 km/h)	Not available

If one of the requirements needed for adaptive cruise assist or the lane departure warning is no longer met, the system can only function with limitations.

Emergency assist functions

Measures may be initiated in stages. The vehicle can intervene within the limits of the system. The measures depend on the dangerous situation and the vehicle equipment:

- Visual and audio warnings
- Vehicle control
- Reduction of vehicle speed in stages
- Lowers the volume of the Infotainment system
- Tugs on the safety belt
- Activates the brakes
- The emergency flashers are activated
- Audi pre sense preemptive safety measures are triggered ⇒ *page 159*
- The brakes are applied until the vehicle is stationary

As soon as the vehicle comes to a full stop, it prepares for the persons in the vehicle to be rescued. The parking brake is set, the “P” selector lever position is engaged, the doors are unlocked, and the interior lighting is activated. The emergency ►

call¹⁾ will be started if necessary once the vehicle has been stationary for several seconds.

Display

If  is displayed for example, the emergency assist lane guidance is active.

Overriding the emergency assist

You can override emergency assist as follows

⇒ :

- Move the steering wheel, or
- Press the brake pedal, or
- Press the accelerator pedal distinctly.



When stationary, you can end the emergency assist by shifting out of the "P" position or releasing the parking brake ⇒ *page 114*.

Switching the emergency assist on and off

You can turn the emergency assist on or off in the **Driver assistance** menu ⇒ *page 131*.

If you switch the system off, the  indicator light will turn on and a corresponding message will appear.

Messages

If  or  is displayed when there is a malfunction, the emergency assist functions may be unavailable or may be limited.

A message that indicates the cause and possible solution may appear with some displays. The weather conditions may be too poor or a sensor may be covered. Clean the area in front of the sensors ⇒ *page 130* and try to turn the system on again later.

If the malfunction remains, drive to an authorized Audi dealer or authorized Audi Service Facility immediately to have the malfunction corrected.

– The emergency assist is an assist system that should only be used in cases of emergency to take over control of the vehicle and bring it to a stop.

Tips

- Depending on the severity of the detected situation, not all safety measures will be initiated. Certain functions can be adjusted or skipped if necessary.
- If the emergency assist was triggered, it will only be available again after a brief period.

WARNING

- Observe the safety precautions and note the limits of the assist systems, sensors, and cameras ⇒ *page 127* to ⇒ *page 130*.

¹⁾ This function is not available in every market and on all vehicle equipment levels.

Parking and maneuvering

Introduction

Depending on the vehicle equipment, various parking aids will help you when parking and maneuvering.

Parking aid

The **parking aid plus** assists you while parking using audio and visual signals to warn you about objects detected in front of, behind, and next to* the vehicle ⇒ *page 169*.

The **rearview camera** shows the area behind the vehicle in the MMI display. The lines in the rearview camera image help you to park and maneuver ⇒ *page 172*.

The **peripheral cameras** are an addition to the rearview camera and help you to see various areas around the vehicle while parking and maneuvering ⇒ *page 172*.

The **rear cross-traffic assist** can warn you of approaching cross traffic when driving in reverse or exiting a parking space ⇒ *page 176*.

The **maneuver assist** assists you when maneuvering ⇒ *page 188*.

Assisted parking

The following systems help you to locate suitable parking spaces ⇒ *page 177* and to park in them and exit them. The driver must always monitor the area around the vehicle and supervise the process of parking or exiting a parking space.

Park assist plus helps when parking in available parking spaces and when exiting them. This occurs either in the vehicle by pressing a drive button ⇒ *page 179* or, if equipped with **Remote park assist plus**¹⁾, from outside the vehicle by remote control using a mobile device ⇒ *page 183*. The systems control steering, gear selection, acceleration, and braking.

Possible settings

You can adjust parking aid functions according to your preferences. The possible settings depend on the vehicle equipment.

- **Automatic activation** ⇒ *page 170*
- **Front and rear volume** ⇒ *page 171*
- **Entertainment fader** ⇒ *page 171*.
- **Clean rearview camera** ⇒ *page 172*
- **View** ⇒ *page 174*
- **Rear cross-traffic assist** ⇒ *page 176*
- **Maneuver assist** ⇒ *page 188*

WARNING

Observe the safety precautions and note the limits of the assist systems, sensors, and cameras ⇒ *page 127* to ⇒ *page 130*.

Tips

Audi recommends practicing parking in a traffic-free location or parking lot to become familiar with the systems. Practice parking in good light and weather conditions.

Parking aid plus

Activating and deactivating

Applies to: vehicles with parking aid plus

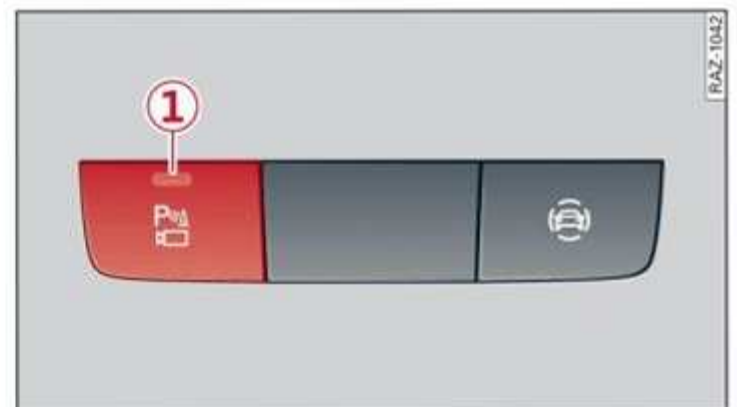

Fig. 126 Center console: parking aid button

General information

The parking aid assists when parking and maneuvering by providing warnings about obstacles. If the ultrasonic sensors on the vehicle ⇒ *page 128*, *fig. 92* detect an obstacle, the system will provide audio and visual warnings. ▶

¹⁾ System availability may be limited depending on the market.

Activating and deactivating

Requirement: the vehicle speed must be under approximately 6 mph (10 km/h).

- ▶ Press the **P** or **P₊** button **1** in the center console.

Depending on the country, it may not be possible to switch the system off when the reverse gear is selected.

Automatic activation

- ▶ The system activates automatically when reverse gear is engaged while the engine is running, or

If **Automatic activation** is switched on ⇒ *page 131* in the **Parking aid** menu and if the vehicle approaches an obstacle when driving forward at speeds below approximately 6 mph (10 km/h), the parking aid will activate automatically. Audible signals will sound once the obstacle is within the sensor detection area.

Automatic deactivation

If you drive forward faster than 6 mph (10 km/h), the system will deactivate automatically.

WARNING

Observe the safety precautions and note the limits of the assist systems, sensors, and cameras ⇒ *page 127* to ⇒ *page 130*.

Note

Keep enough distance from the curb to avoid damage to the rims.

Tips

- If the parking aid is deactivated, it can only be reactivated automatically when one of the following conditions is met:
 - The vehicle speed exceeds 6 mph (10 km/h)
 - The ignition is switched off and back on again
 - The parking brake is set and then released
 - The “P” selector lever position is engaged and released again

Warnings

Applies to: vehicles with parking aid plus

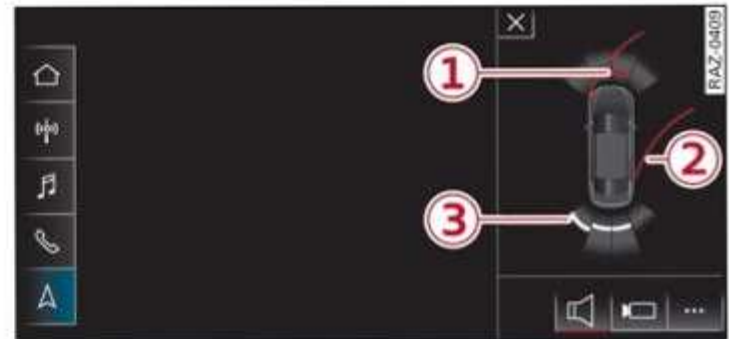

Fig. 127 Upper display: distance indicator

If the sensors detect an obstacle, audible and visual signals will warn you.

Visual warnings

The visual warnings in the upper display help you to detect the critical vehicle area and to estimate the distance to an obstacle.

Red segments **1** show detected obstacles that are in your vehicle's path. The red lines **2** mark the expected direction of travel based on the steering angle. A white segment **3** indicates a detected obstacle that is outside of the vehicle's path. The closer your vehicle comes to the obstacle, the closer the segments will move to the vehicle. The collision area has been reached when the next to last segment is displayed. Obstacles in the collision area, including those outside of the vehicle's path, are shown in red. Do not continue driving farther.

Audio signals

The closer your vehicle gets to a detected obstacle, the shorter the time between the audible signals. A continuous tone sounds when an obstacle is less than approximately 1 foot (0.30 m) away from the front or rear of the vehicle. A continuous tone sounds when an obstacle is less than approximately 0.7 feet (0.20 m) away from the sides* of the vehicle. Do not continue driving forward or in reverse ⇒ .

- ▶ To deactivate audio signals when parking or exiting a parking space, press  in the upper display. Depending on the country, the acoustic warnings will be reactivated after changing a gear or when activating the parking aid again. ▶

Adjusting the volume

You can adjust the volume to your preferences in the **Parking aid** menu ⇒ *page 131*. The settings depend on the vehicle equipment.

Possible settings:

Front volume - Volume for the front and side* area.



Rear volume - Volume for the rear area.

Entertainment fader - The volume of the audio/video source is lowered when the parking aid is activated.

Error messages

If  appears, the sensor in the respective area or the speaker is faulty. Drive immediately to an authorized Audi dealer or authorized Audi Service Facility to have the malfunction repaired.

If  is displayed in the MMI, the ultrasonic sensor indicated is icy or dirty. Clean the area in front of the sensors ⇒ *page 130*.

If  or  is displayed when there is a malfunction, the parking aid functions may be unavailable or may be limited.

A message that indicates the cause and possible solution may appear with some displays. The weather conditions may be too poor or a sensor may be covered. Clean the area in front of the sensors ⇒ *page 130* and try to turn on the systems again later.

If the malfunction remains, drive to an authorized Audi dealer or authorized Audi Service Facility immediately to have the malfunction corrected.

WARNING

- Observe the safety precautions and note the limits of the assist systems, sensors, and cameras ⇒ *page 127* to ⇒ *page 130*.
- Sensors and cameras have spots in which the surrounding area cannot be detected. Objects, animals, and people may only be detected with limitations or may not be detected at all. Always monitor the traffic and

the vehicle's surroundings directly and do not become distracted.

Note

- Keep enough distance from the curb to avoid damage to the rims.
- Applies to: vehicles with assisted parking systems: If you park in short parking spaces using assisted parking systems, a continuous tone will sound from the parking aid when the distance to an object is less than approximately 0.7 feet (0.20 m). Do not continue driving farther.

Tips

- The segments in the side area* ⇒ *page 128*, *fig. 92* are detected and analyzed when passing. There may have been changes to the surrounding area after switching the ignition off and on again, after opening the doors, or if the vehicle is left stationary for a period of time. In this case, the area will appear black until the area has been detected and evaluated.
- If the distance to an obstacle remains constant, the volume of the distance warning gradually lowers after a few seconds until it is muted (this does not apply to the continuous tone). If the obstacle comes closer than it was before the sound was muted, the tone will sound again. If the obstacle becomes farther away than it was before the sound was muted, no tone will sound. Pay attention to the vehicle's surroundings when you start to drive.

Rearview camera and peripheral cameras

Introduction

Applies to: vehicles with rearview camera/peripheral cameras

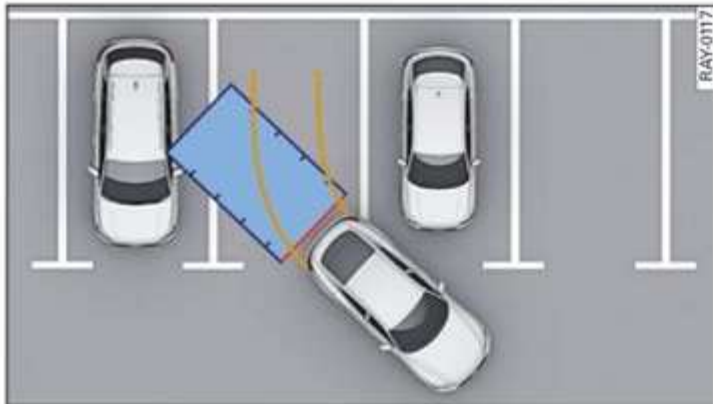

Fig. 128 Orientation line display when parking

Depending on the vehicle equipment, a rearview camera or multiple peripheral cameras may be available.

The **rearview camera** helps you to park or maneuver using the orientation lines.

The **peripheral cameras** expand the vehicle overview to include various views around the vehicle that can be selected.

! WARNING

Observe the safety precautions and note the limits of the assist systems, sensors, and cameras ⇨ page 127 to ⇨ page 130.

Activating and deactivating

Applies to: vehicles with rearview camera/peripheral cameras

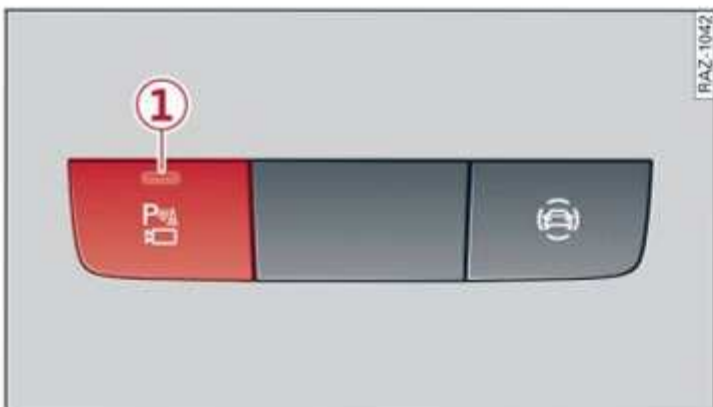

Fig. 129 Center console: parking aid button

Activating and deactivating

► Press the button (1) in the center console, or

► Press in the upper display if the visual distance indicator is shown ⇨ page 170, fig. 127.

The system can be activated at low speeds, such as when maneuvering.

Automatic activation

The system activates automatically when reverse gear is engaged while the engine is running.

Automatic deactivation

The system will deactivate automatically once the vehicle exceeds a certain speed while driving forward.

! WARNING

Observe the safety precautions and note the limits of the assist systems, sensors, and cameras ⇨ page 127 to ⇨ page 130.

Clean rearview camera

Applies to: vehicles with rearview camera/peripheral cameras

You can manually start the cleaning of the rearview camera. The settings depend on the vehicle equipment.

► Select > **Clean rearview camera** in the upper display when the parking aid is active.

! WARNING

Observe the safety precautions and note the limits of the assist systems, sensors, and cameras ⇨ page 127 to ⇨ page 130.

Warnings

Applies to: vehicles with rearview camera/peripheral cameras

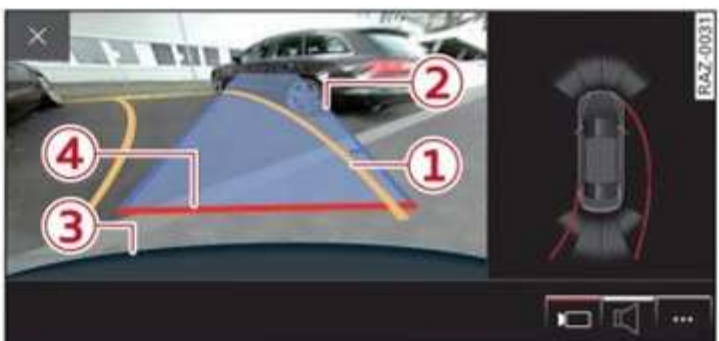



Fig. 130 Upper display: aiming at a parking space

When parking with the rearview camera or peripheral camera, the parking system plus audio ►

and visual warnings* will also assist you
 ⇨ page 170.

Visual orientation lines

- ① The orange orientation lines show the vehicle's direction of travel ⇨ . Turn the steering wheel until the orange orientation lines align with the parking space.
- ② You can use the horizontal blue markings to help you estimate the distance to an obstacle. Each marking represents approximately 3 feet (1 meter). The blue surface is a static display and represents an extension of the vehicle perimeter to the rear.
- ③ You can recognize the rear bumper in the lower display.
- ④ You should stop driving in reverse when the red orientation line touches the edge of an object, at the latest.

Symbols

Applies to: vehicles with peripheral cameras

If  is displayed and the display area represented by that symbol is not available, then the camera on the that side is not available. The power exterior mirrors may have been folded in or a door or the luggage compartment lid may have been opened.

If  is displayed, there is a system malfunction and the display area represented by that symbol is not available. The camera is not working in this area.

If  is displayed, the respective ultrasonic sensor is icy or dirty. Clean the area in front of the sensors ⇨ page 130.

If one of the symbols continues to be displayed, drive immediately to an authorized Audi dealer or authorized Audi Service Facility to have the malfunction repaired.

WARNING

- Observe the safety precautions and note the limits of the assist systems, sensors, and cameras ⇨ page 127 to ⇨ page 130.
- Sensors and cameras have spots in which the surrounding area cannot be detected. Objects, animals, and people may only be detected with limitations or may not be detected at all. Always monitor the traffic and the vehicle's surroundings directly and do not become distracted.

Note

- The orange orientation lines ① show the direction the rear of the vehicle will be traveling, based on the steering wheel angle. The front of the vehicle swings out more than the rear of the vehicle. Maintain plenty of distance so that an exterior mirror or a corner of the vehicle does not collide with any obstacles.
- Keep enough distance from the curb to avoid damage to the rims.
- Only use the images provided by the camera on the rear of the vehicle when the luggage compartment lid is completely closed. Make sure any objects you may have mounted on the luggage compartment lid do not block the rearview camera.

Tips

Applies to: vehicles with air suspension: The accuracy of the orientation lines and blue surfaces on the camera display decreases when the vehicle is raised or lowered with the air suspension.

Operating the peripheral cameras

Applies to: vehicles with peripheral cameras

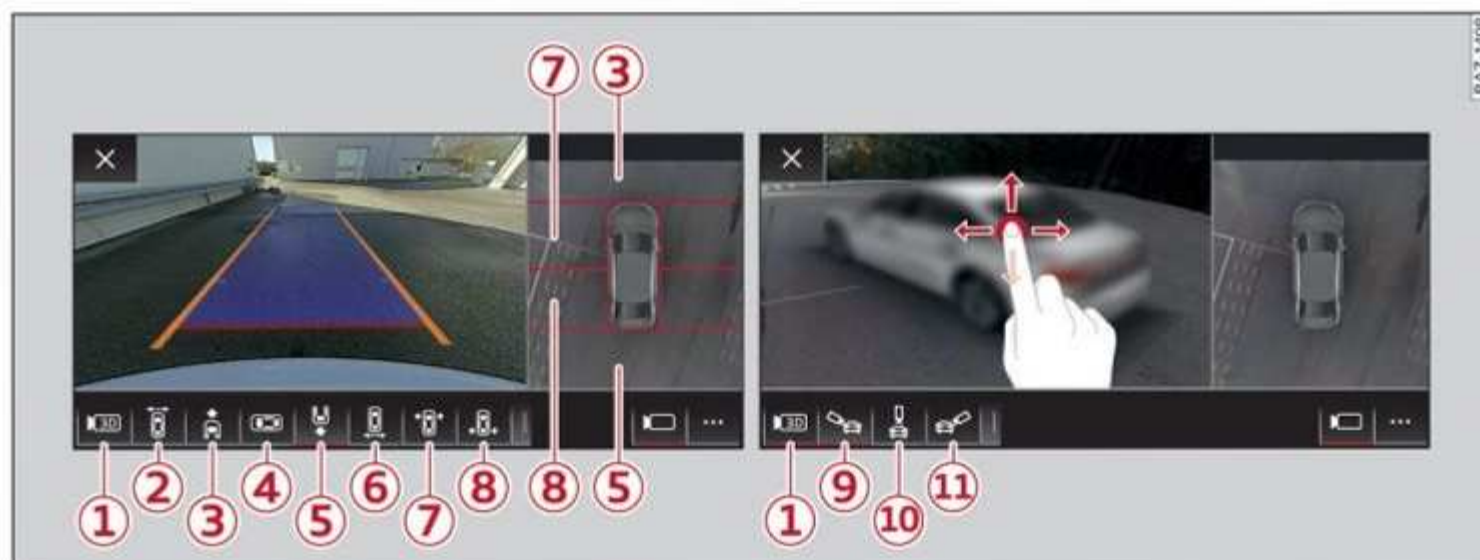

Fig. 131 Upper display: left: rear view. Right side: 3D surroundings.

On vehicles with peripheral cameras, you can select among different views.

The camera views can be controlled with the touch display. In certain views, you can zoom in or out on the displayed area, and move, tilt, or rotate the **3D surroundings**.

Selecting the views

- ▶ To display the entire selection bar, tap the current view (2) or swipe at the edge of the selection bar from left to right.
- ▶ To select a view, press (2) - (8) or tap in an area to show the vehicle in the side view ¹⁾.
- ▶ To select a **3D surroundings** view, press the **3D** symbol (1). Then select the desired **3D surroundings** view (9) - (11).

Switching the views quickly

To switch the views quickly (for example, from **Front corner** to **Front**):

- ▶ Tap the camera image twice, or
- ▶ Pull two fingers apart or together in a sideways motion on the camera image.

Zooming in and out on the views

Applies to: surroundings and 3D surroundings views

- ▶ To zoom in or out on an area, place two fingers on that area and push them apart or pull them together ⇨ *fig. 131*, left side.

Moving the view

Applies to: surroundings and 3D surroundings views

- ▶ To move the view, press and pull it in any direction using one finger.
- ▶ To re-center the **3D surroundings**, tap the camera image twice.

Tilting or rotating the views



Applies to: 3D surroundings view

- ▶ To tilt or rotate the **3D surroundings**, use your finger to drag it in any direction ⇨ *fig. 131*, on the right side.
- ▶ To re-center the **3D surroundings** behind the vehicle, tap the camera image twice.

Selecting a view in the side area

The vehicle surroundings are shown in the side area of the display. You can adjust the view to your preferences in the **Parking aid** menu ⇨ *page 131*. You can switch between a visual display (**Graphic**) and the vehicle surroundings (**Camera**). ▶

¹⁾ Requirement: The vehicle surroundings (**Camera**) is selected and visible in the **View** in the side area.

	Symbol/Description	Description
①		Switch between 3D surroundings and Surroundings
②	Front corner or Display selection bar	This view makes it easier to drive out of tight parking spaces or areas and intersections with poor visibility. It shows an almost 180° panorama view in front of the vehicle.
③	Front	This view assists you in using the full area for maneuvering in front of the vehicle.
④	Surroundings	This view helps you to maneuver and position the vehicle more precisely. The area around the vehicle is shown using the camera images. The vehicle image is shown by the system ⇨  .
⑤	Rear	This view assists you in using the full area for maneuvering behind the vehicle. This is the rearview camera image.
⑥	Rear corner	This view can assist you when driving out of tight parking spaces or areas with poor visibility. It shows an almost 180° panorama view behind the vehicle.
⑦	Front tires	This view helps you to see the distance between the front tires and the curb and the steering wheel angle when parking.
⑧	Rear tires	This view helps you to detect the distance between the rear wheels and the curb when parking.
⑨⑩⑪	3D surroundings	In these views, you can see the areas surrounding the vehicle in 3D when parking. The vehicle surrounding views are created from the camera images and sensor data. The vehicle image is shown by the system ⇨  .

 **WARNING**

- Observe the safety precautions and note the limits of the assist systems, sensors, and cameras ⇨ *page 127* to ⇨ *page 130*.
- The **Surroundings** and **3D surroundings** are created from the individual camera images. The vehicle image is shown by the system. Objects and obstacles above the camera are not displayed.

 **Note**

Only use the images provided by the camera on the rear of the vehicle when the luggage compartment lid is completely closed. Make sure any objects you may have mounted on the luggage compartment lid do not block the rearview camera.

 **Tips**

- Depending on the selected gear, it will automatically switch between the **Front** and

Rear views. If you switch the view manually, the automatic front/rear camera change will be temporarily deactivated.

- When first activated while a forward gear is engaged, the **Front corner** is displayed.

Rear cross-traffic assist

Description

Applies to: vehicles with rear cross-traffic assist



Fig. 132 Sensor detection range for rear cross-traffic assist



Fig. 133 Upper display: rear cross-traffic assist display

General information

The rear cross-traffic assist monitors the area behind and next to the vehicle using radar sensors at the rear corners of the vehicle. The system can detect moving objects that are approaching, such as vehicles ⇒ *fig. 132*. A display in the MMI ① and various warnings provide assistance when exiting a parking space.

Requirements for using the rear cross-traffic assist:

- The parking aid is active ⇒ *page 169*.
- The speed while driving backwards is not higher than approximately 6 mph (10 km/h).

Displays, warnings, and braking

- **Display:** the display ① appears only when the parking aid is active. In vehicles with peripheral cameras, the display only appears in the **Rear** and **Rear corner** camera views. Arrows show the direction from which the cross traffic is approaching.



- **Audible warnings:** an audio signal may sound as an additional warning when driving in reverse.
- **Automatic brake activation:** if you do not react to a warning, a brief braking by the system can warn you of a potential collision with an approaching object.

The audible warning signal and the automatic brake activation occur only when driving in reverse.

Switching the rear cross-traffic assist on and off

You can turn the rear cross-traffic assist on or off in the **Parking aid** menu ⇒ *page 137*.

Messages

If , , or  is displayed when there is a malfunction, the rear cross traffic assist functions may be unavailable or may be limited.

A message that indicates the cause and possible solution may appear with some displays. The weather conditions may be too poor or a sensor may be covered. Clean the sensor area in the vehicle rear and try to turn the system on again later.

If the malfunction remains, drive to an authorized Audi dealer or authorized Audi Service Facility immediately to have the malfunction corrected.

WARNING

- Observe the safety precautions and note the limits of the assist systems, sensors, and cameras ⇒ *page 127* to ⇒ *page 130*.
- The rear cross-traffic assist will not provide alerts about people and cannot warn you about every type of approaching object, such as bicycles. Always monitor the traffic situation as well as the vehicle's surroundings with direct eye contact.
- The system may not react at all or it may not react on time when objects are approaching very quickly.
- The rear cross-traffic assist will not provide alerts if your vehicle is parallel parked or if your vehicle is pulled too far into the

parking space so that it is hidden by adjacent vehicles.

i Tips

- Once an automatic brake activation occurs, the system cannot initiate another activation for several seconds.
- System functions may not be available if the ESC is limited or switched off, or if there is a malfunction.
- If there is an audio warning signal from the rear cross-traffic assist, then the parking aid may not be able to provide audio warnings about detected obstacles under certain circumstances.
- The coverage areas of the sensors ⇒ *fig. 132* are diagrams and do not represent a true-to-scale image of the sensor ranges.
- The system complies with United States FCC regulations and ISED regulations ⇒ *page 325*.

Assisted parking

General information

Applies to: vehicles with assisted parking

If your vehicle is equipped with park assist plus or remote park assist plus, these systems will help you to find suitable parking spaces. Parking spaces are measured using ultrasonic sensors on the sides of the vehicle. Depending on vehicle equipment, the laser scanner may also improve the measurement.

If a parking space is found, the systems will help you to park while the driver monitors the vehicle's surroundings with the parking aids, cameras*, and direct eye contact.

! WARNING

Observe the safety precautions and note the limits of the assist systems, sensors, and cameras ⇒ *page 127* to ⇒ *page 130*.

Parking options

Applies to: vehicles with assisted parking

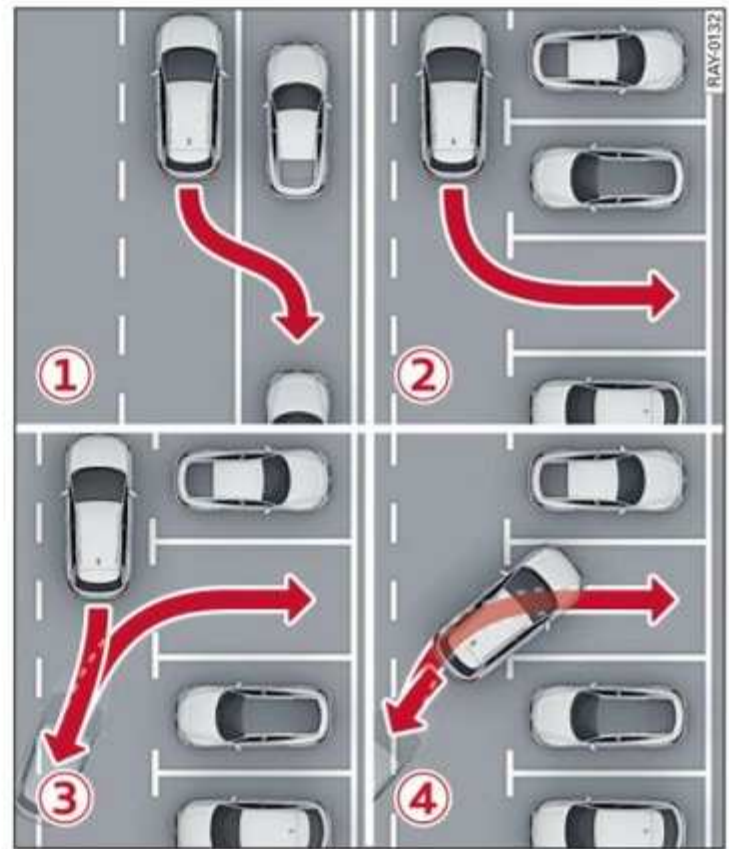

Fig. 134 Parking options overview

The following parking options may be available depending on the activation timing and the vehicle equipment:

- After a prior parking space search ① – ③ ⇒ *page 178, Parking space search*.
 - After trying to park yourself, if you have driven past a parking space yourself ④. The front of the vehicle should already be far enough into the parking space so that the sensors can measure the space.
- ① Backing into parallel parking spaces
 - ② Backing into perpendicular parking spaces
 - ③ Driving forward into perpendicular parking spaces that you have already driven past
 - ④ Driving forward into perpendicular parking spaces

Options for exiting parking spaces

Applies to: vehicles with assisted parking

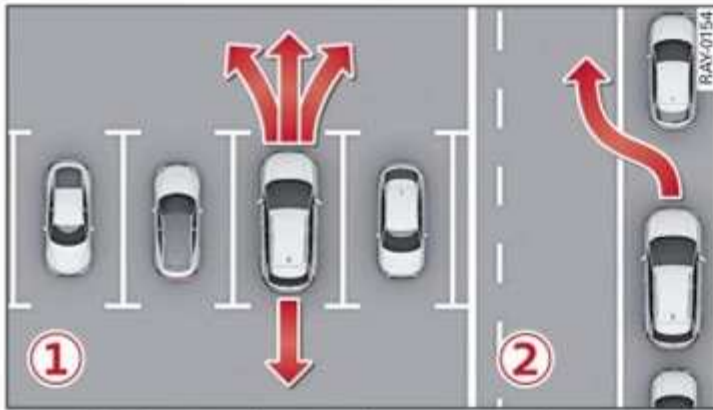

Fig. 135 Overview of options for exiting a parking space

Depending on the vehicle equipment, the following options for exiting parking spaces may be available:

- ① Exiting perpendicular parking spaces¹⁾
- ② Exiting parallel parking spaces

Parking space search

Applies to: vehicles with assisted parking



Fig. 136 Upper display: activated parking space search

- ① Parking options display
- ② Arrows and symbols indicate the necessary actions, such as continuing to drive straight or applying the brakes
- ③ Parking space detected and selected by the system

Activating the parking space search

- ▶ Press **P** in the lower display, or
- ▶ To activate the parking space search when the parking aid is activated, press **P** in the upper display.

The display for the parking space search appears in the upper display ⇒ *fig. 136*.

Searching for parking spaces

- ▶ Drive forward to the row of parking spaces at a low speed. For the best parking results, the vehicle should be approximately 3 feet (1 m) from the row of parking spaces.
- ▶ The parking space search is first done on the side of your lane. To switch the side for the parking space search, activate the turn signal for that side. Depending on vehicle equipment, you may also be able to press on the side next to your vehicle in the upper display.

Selecting the parking space

If the system finds a parking space that could be suitable for the vehicle length and width, it will be displayed. The system automatically suggests a parking option ①.

If the parking space allows different parking options, they can be selected manually. Press one of the suggested parking options ①.

Starting the parking process

To reach the correct starting position, follow the visual instructions in the upper display ②. Once the vehicle has reached the correct position, a **P** will appear above the selected parking space ③.

- ▶ Keep the vehicle as parallel as possible to the parked vehicles or to the side of the road.
- ▶ Make sure that the parking space is suitable for your vehicle ⇒ .

Depending on vehicle equipment and the applicable legal regulations, you may start the assisted parking process after selecting the parking space ①:

- In the vehicle: parking with park assist plus and the **>>P** button ⇒ *page 180*.
- Outside of the vehicle: remote controlled parking with a mobile device ⇒ *page 183* ▶

¹⁾ Only remote controlled parking.

Maneuvering area

The vehicle can go off course during the parking process ⇒ . If there are obstacles within the maneuvering area that block or endanger the parking process, for example on the opposite side of the street, a message may appear. You may need to drive farther forward and stay closer to the row of parking spaces.

WARNING

- Observe the safety precautions and note the limits of the assist systems, sensors, and cameras ⇒ *page 127* to ⇒ *page 130*.
- The driver is always responsible when entering or exiting a parking space and during similar maneuvers.
- Sensors and cameras have spots in which the surrounding area cannot be detected. Objects, animals, and people may only be detected with limitations or may not be detected at all. Always monitor the traffic and the vehicle's surroundings directly and do not become distracted.

Note

- Parking spaces classified as suitable by the system may have been detected incorrectly. The driver must decide if the parking space displayed is suitable for the vehicle.
- Certain objects (such as trees and posts) or types of ground (such as gravel, snow, and ice) in the area of the parking space may result in the vehicle not being positioned as it normally would be at the end of the parking process. This increases the risk of collisions.

Tips

- If you did not drive past a suitable parking space too quickly, the system can also be activated afterward by pressing **P**.
- The Electronic Stabilization Control (ESC) must not be switched off during the parking process. If the ESC intervenes, the parking process will be canceled.
- You can also drive into a perpendicular parking space yourself and then activate the system. If this is the case, the front of the vehi-

cle should already be in the space  ⇒ *page 177, fig. 134* so that the sensors can measure the space.

- The system is not available when certain assist systems are switched on.
- If there are suitable parking spaces on both sides of the street, for example, on a one-way street, you can change the side where the system is searching for parking spaces by activating the turn signal for the other side or by pressing on that side in the upper display.
- The park systems do not provide support for assisted parking on tight curves.

Park assist plus

General information

Applies to: vehicles with park assist plus

Park assist plus parks the vehicle after the parking space search and also exits parallel parking spaces. While the driver presses and holds the **>>P** button and monitors the vehicle's surroundings, park assist plus controls the steering, acceleration, braking, and gear selection.

WARNING

- Observe the safety precautions and note the limits of the assist systems, sensors, and cameras ⇒ *page 127* to ⇒ *page 130*.
- The driver is always responsible when entering or exiting a parking space and during similar maneuvers.
- Do not use this function if the vehicle cannot move freely, for example when on a vehicle jack.
- Sensors and cameras have spots in which the surrounding area cannot be detected. Objects, animals, and people may only be detected with limitations or may not be detected at all. Always monitor the traffic and the vehicle's surroundings directly and do not become distracted.

! Note

- Do not use park assist plus when transporting cargo that extends outside of the vehicle or when snow chains are mounted.
- Park assist plus and remote controlled parking guides the vehicle either away from curbs or onto them if other vehicles are parked on the curb. Make sure that your vehicle's tires and rims are not damaged. Resume control of the vehicle in time or stop the process of parking or exiting the parking space.

i Tips

Follow the legal regulations in the country where you are operating the vehicle when using park assist plus. Park assist plus may be prohibited in some countries. The system may be unavailable in countries where it has been deactivated in order to comply with legal regulations. Data will not be transmitted to Audi. The driver is always responsible for adhering to the regulations applicable in the country where the vehicle is being operated.

Parking with park assist plus

Applies to: vehicles with park assist plus

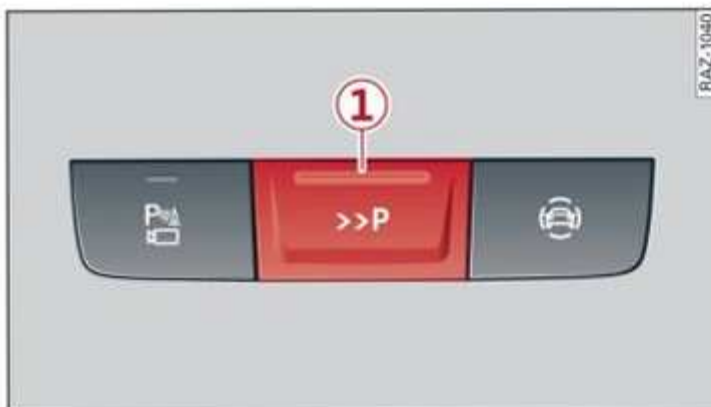

Fig. 137 Center console: park assist plus button

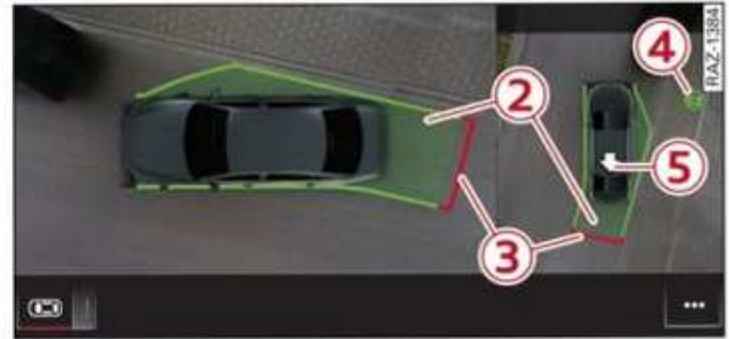

Fig. 138 Upper display: park assist plus display

Requirement: a suitable parking space must be found and selected ⇒ *page 177*. The vehicle must initially be stationary and the brakes must be pressed.

- ▶ Remove your hands from the steering wheel.
- ▶ Pay attention to the path of the vehicle. If the traffic situation permits it, press and hold the **>>P** button ① and release the brakes ⇒ ⚠.
- ▶ In situations where conditions are unclear, pause the parking process by releasing the **>>P** button. For example, this may be necessary if an obstacle appears or if the vehicle comes very close to an obstacle.
- ▶ To resume the parking process, press and hold the **>>P** button again. The remainder of the parking process will be recalculated based on the vehicle position.

LED in the button ①

The LED informs about the availability of park assist plus:

- **Pulsating white** – park assist plus is ready to control the parking process automatically or to resume after an interruption.
- **Green** – park assist plus is active.
- **Red** – park assist plus was paused or stopped. A message will appear in the instrument cluster display ⇒ *page 182*.

Indicator in the upper display

The current driving maneuver and the status of the park assist plus are shown in the upper display¹⁾:

- ② Path that the vehicle will travel during the current parking maneuver

¹⁾ The displays are only completely available in certain views from the peripheral cameras.

- ③ End point of the current parking maneuver/
direction change
- ④  Park assist plus active
- ⑤ Driving direction display

End of the parking process

The parking process will end automatically once the vehicle has reached the end point in the parking space. After park assist plus finishes parking successfully, the parking lock will be engaged and the parking brake will be set.

Pause park assist plus ⇨ *page 182*.

WARNING

- Observe the safety precautions and note the limits of the assist systems, sensors, and cameras ⇨ *page 127* to ⇨ *page 130*.
- Press and hold the  button only if you are sure that there are no obstacles in the vehicle's path or under the vehicle, and that no obstacles will move into the vehicle's path.
- Park assist plus is an assist system. The driver is still responsible for monitoring the vehicle's surroundings and preventing collisions when using the system.
- When using park assist plus to enter or exit a parking space, the steering wheel turns quickly on its own. Reaching into the steering wheel spokes while this is happening can result in injury.

Tips

- You can reduce the speed specified by the system at any time by pressing the brake pedal.
- The system can incorrectly interpret parking space barriers (such as parking curbs). Take over the parking process ⇨ *page 182* if the vehicle is not completely inside the parking space or if the vehicle tries to drive over the parking space barrier.
- The image in the display is an enlarged and distorted image. Under certain circumstances, objects may appear different and unclear on the display. This is especially true if there are objects that do not touch the







ground, such as the bumper of a parked vehicle or the rear of a truck. Drive with special care and do not use the image if necessary.

- Applies to: vehicles with air suspension: The accuracy of the orientation lines and green surfaces in the display decreases when the vehicle is raised or lowered with the air suspension.

Exiting a parking space with park assist plus

Applies to: vehicles with park assist plus

If you parked the vehicle in a parallel parking space, park assist plus can help you to exit the space.

- ▶ Start the engine.
- ▶ Press  in the lower display.
- ▶ Wait until a message appears on the upper display that requests you to select the direction to travel in when exiting the parking space.
- ▶ Activate the turn signal on the desired side or press that side next to the vehicle in the upper display.
- ▶ Select a selector lever position.
- ▶ Remove your hands from the steering wheel.
- ▶ Pay attention to the path of the vehicle. If the traffic situation permits it, press and hold the  button ① ⇨ *page 180*, *fig. 137* and release the brakes ⇨ .
- ▶ If an obstacle appears, interrupt the process of exiting the parking space by releasing the  button. The vehicle will remain stationary.
- ▶ To resume the process of exiting the parking space, press and hold the  button again.
- ▶ The process of exiting the parking space has ended if additional corrective movements are no longer necessary and the specified steering wheel angle is sufficient to drive out of the parking space. Resume control of the steering wheel ⇨ .

Pause park assist plus ⇨ *page 182*. ▶

WARNING

- Observe the safety precautions and note the limits of the assist systems, sensors, and cameras ⇒ *page 127* to ⇒ *page 130*.
- Press and hold the  button only if you are sure that there are no obstacles in the vehicle's path or under the vehicle, and that no obstacles will move into the vehicle's path.
- Park assist plus is an assist system. The driver is still responsible for monitoring the vehicle's surroundings and preventing collisions when using the system.
- When using park assist plus to enter or exit a parking space, the steering wheel turns quickly on its own. Reaching into the steering wheel spokes while this is happening can result in injury.

Note



Resume steering immediately after the last corrective movement and the takeover prompt, so that the specified steering wheel angle is not recentered.

Tips

You can reduce the speed selected by the vehicle or stop the vehicle at any time by pressing the brake pedal.

Pausing park assist plus

Applies to: vehicles with park assist plus

You can pause park assist plus at any time by releasing the  button  ⇒ *page 180*, *fig. 137*. To resume the process of parking or exiting the parking space, press and hold the  button again.

Canceling automatically

Park assist plus is canceled automatically among other things, if:

- You switch off the system
- You take over steering or press the brake pedal
- The time limit is exceeded
- An obstacle is detected
- The ESC intervenes

Resume control of the vehicle, end the process of parking or exiting the parking space manually, or:



You can resume the parking process in some situations. Press and hold the brake pedal and press .

WARNING

Observe the safety precautions and note the limits of the assist systems, sensors, and cameras ⇒ *page 127* to ⇒ *page 130*.

Messages

Applies to: vehicles with park assist plus

If the , , or  indicator light turns on, the park assist is not available or was interrupted.

A message that indicates the cause and possible solution may appear with some displays. The weather conditions may be too poor or a sensor may be covered. Clean the area in front of the sensors ⇒ *page 130* and try to turn the system on again later.

If the malfunction remains, drive to an authorized Audi dealer or authorized Audi Service Facility immediately to have the malfunction corrected.

Remote controlled parking¹⁾²⁾

General information²⁾

Applies to: vehicles with remote park assist plus

Remote controlled parking is part of park assist plus. The process for parking or exiting a parking space can be controlled with a mobile device from outside the vehicle. To do so, you must have both the vehicle key and the mobile device with you. While you control the vehicle remotely and monitor the vehicle's surroundings, the system controls the steering, gear selection, acceleration, braking, and locking of the vehicle. For the process of parking or exiting the parking space to function correctly, there must not be any occupants inside the vehicle.

WARNING

- Observe the safety precautions and note the limits of the assist systems, sensors, and cameras ⇒ *page 127* to ⇒ *page 130*.
- Remote controlled parking is only an assist system. The driver is always responsible for maneuvering, driving, and stopping the vehicle and performing other driving maneuvers.
- Do not use this function if the vehicle cannot move freely, for example when on a vehicle jack.
- Failing to pay careful attention to the vehicle's surroundings increases the risk of an accident. Sensors and cameras have spots in which the surrounding area cannot be detected. Objects, animals, and people may only be detected with limitations or may not be detected at all. Always monitor the traffic situation as well as the vehicle's surroundings with direct eye contact. Stay near the vehicle while controlling it. Make sure you have a clear view of the vehicle and the

area surrounding it. Do not become distracted.

- Applies to: vehicles with anti-theft alarm system: There is a risk of fatal injury for people locked in the vehicle, especially children. The vehicle is locked during remote controlled parking. Make sure there are no persons inside the vehicle both before and after using remote controlled parking.
- There is a risk of asphyxiation. Never allow the engine to run in confined spaces. After remote controlled parking, make sure the engine is off.
- Malfunctions when using the myAudi app increase the risk of an accident. Do not exit the app during the parking process, and make sure that it does not go into the device background, for example by accepting an incoming call. Observe the operating instructions from the manufacturer of your mobile device.
- There is a risk of accident if the connection is interrupted. In certain situations, the connection between the mobile device and the vehicle can be interrupted, for example from other radio devices or when the distance to the vehicle is too far. Make sure the connection is sufficient, and when in doubt, resume parking the vehicle or exiting the parking space yourself.
- Blocking notifications, tones, and vibrations increase the risk of an accident. The myAudi app can only warn you if dangers are detected if you make sure that your mobile device allows all notifications, tones, and vibrations for the myAudi app.

Note

- Do not use remote controlled parking when transporting cargo that projects outside of the vehicle or when snow chains are mounted.

¹⁾ System availability may be limited depending on the market.

²⁾ The function or equipment that is described was in development at the time this manual was published and may not be available in your vehicle.

- Remote controlled parking may guide the vehicle either away from curbs or onto them if other vehicles are parked on the curb. Make sure that your vehicle's tires and rims are not damaged. Resume control of the vehicle in time or stop the process of parking or exiting the parking space.

Tips

- Follow the legal regulations in the country where you are operating the vehicle when using remote controlled parking. Remote controlled parking may be prohibited in some countries. The system may be unavailable in countries where it has been deactivated in order to comply with legal regulations. Data will not be transmitted to Audi. The driver is always responsible for adhering to the regulations applicable in the country where the vehicle is being operated.
- Any individual that uses the mobile device for remote controlled parking is considered the driver and is participating in traffic. The driver is always responsible for adhering to the regulations for using remote controlled parking that are applicable in the country where the vehicle is being operated.
- Do not endanger any other road users when using remote controlled parking. Testing remote controlled parking in a parking lot with minimal traffic is recommended.
- Your mobile device should have a sufficient battery charge level. If necessary, charge the mobile device before starting to drive.
- Do not use the remote controlled parking function with devices that are faulty or damaged or whose function is impaired. Only use the operating systems approved by the mobile device manufacturer.
- When using remote controlled parking, always pay attention to the areas where your vehicle can be accessed. Make sure that no

one can enter your vehicle and that the vehicle has been locked after the parking process is completed. Take the vehicle key with you when leaving the vehicle.

Setup¹⁾²⁾

Applies to: vehicles with remote park assist plus

The following steps must be completed before using for the first time:

- ▶ Create a myAudi account by registering in the myAudi app or at my.audi.com, depending on your country.
- ▶ Add your vehicle to your myAudi account.
- ▶ Set the key user ⇒ [page 34](#).
- ▶ Install the myAudi app on your mobile device and log in with your access information.

Device compatibility

The mobile device will be checked when the process for parking or exiting a parking space begins. If an incompatibility is detected, it will be displayed in the myAudi app. Audi does not recommend using the function if an incompatibility is detected ⇒ .

A selection of supported Bluetooth devices can be found in the database for tested mobile devices at www.audi.com/bluetooth. Compatibility cannot be guaranteed for all types of mobile devices. The availability depends on the following factors, among others:

- Brand and build version of the mobile device
- Version of the mobile device operating system
- Software version of the app used
- Individual settings on the mobile device

WARNING

- Observe the safety precautions and note the limits of the assist systems, sensors, and cameras ⇒ [page 127](#) to ⇒ [page 130](#).
- There is a risk of an accident if an incompatible mobile device is used. If there is a

1) System availability may be limited depending on the market.

2) The function or equipment that is described was in development at the time this manual was published and may not be available in your vehicle.

display indicating that functionality is restricted, the vehicle's reaction speed may be impaired due to reduced transmission speed.

Parking options¹⁾²⁾

Applies to: vehicles with remote park assist plus

Depending on the vehicle equipment, you may have the following options when using remote controlled parking:

Driving into parking spaces

- Parallel parking on the left or right side of the street ① ⇒ page 177, fig. 134
- Driving forward or backing into perpendicular parking spaces ②/③ ⇒ page 177, fig. 134.

Exiting parking spaces

- Exiting perpendicular parking spaces ① ⇒ page 178, fig. 135.
- Exiting parallel parking spaces ②.

WARNING

Observe the safety precautions and note the limits of the assist systems, sensors, and cameras ⇒ page 127 to ⇒ page 130.

Parking with the myAudi app¹⁾²⁾

Applies to: vehicles with remote park assist plus



Fig. 139 Upper display: remote controlled parking - preparing the vehicle

Requirements

- ▶ The setup has been completed.
- ▶ You are logged into the vehicle with your myAudi user.
- ▶ Bluetooth is switched on in the mobile device and in the MMI ⇒ page 247.
- ▶ A suitable parking space has been found and a parking option selected, for example a parallel parking space ①.
- ▶ The vehicle must initially be stationary.
- ▶ The ESC is not limited or switched off.

Preparing the vehicle

- ▶ To enable the selected parking space ② for remote controlled parking, press  ③ on the upper display.
- ▶ If you have already approached a parking space in the vehicle, remote controlled parking can be activated to continue with the rest of the parking process. To enable remote controlled parking, press  in the upper display.
- ▶ Exit the vehicle while the engine is running and take the vehicle key with you. Always keep both the vehicle key and the mobile device with you during the entire remote controlled parking process.
- ▶ Make sure that all doors and the luggage compartment lid are closed.

Starting the parking process

- ▶ Start the myAudi app soon, or the function will be canceled.
- ▶ Pay attention to the path of the vehicle. If the traffic situation permits, park your vehicle in the parking space using the mobile device ⇒ . The vehicle key and the mobile device cannot be more than approximately 20 feet (6 m) away from the vehicle.
- ▶ In unclear situations, pause the parking process using the mobile device. For example, this may be necessary if an obstacle appears or if the vehicle comes very close to an obstacle. ▶

¹⁾ System availability may be limited depending on the market.
²⁾ The function or equipment that is described was in development at the time this manual was published and may not be available in your vehicle.

- ▶ To resume the parking process, start it again on the mobile device. The remainder of the parking process will be recalculated based on the vehicle position.

Unexpected interruption of the parking process

- ▶ If the parking process is interrupted unexpectedly because of the vehicle key, change your location together with the mobile device and vehicle key and resume the parking process.

End of the parking process

If an obstacle appears, stop the parking process ⇒ *page 187*.

The parking process will end automatically once the vehicle has reached the end point in the parking space. Once parking is successfully completed, the parking lock will be engaged, the parking brake will be set, and the engine will switch off. The vehicle will also be locked.

WARNING

- Observe the safety precautions and note the limits of the assist systems, sensors, and cameras ⇒ *page 127* to ⇒ *page 130*.
- Failing to pay careful attention to the vehicle's surroundings increases the risk of an accident. Park your vehicle with the mobile device only if you are sure that no obstacle is in the vehicle's path or under the vehicle, and that no obstacles will move into the vehicle's path.

Tips

- The parking process can only be started if the vehicle key is located outside the vehicle after the vehicle is prepared. Always keep both the vehicle key and the mobile device with you during the entire remote controlled parking process.

- Remote controlled parking may be restricted or unavailable in situations such as the following:
 - If the ESC is restricted or switched off, or if there is a malfunction.
 - If there is another vehicle key inside the vehicle or nearby.
- The system can incorrectly interpret parking space barriers (such as parking curbs). Take over the parking process ⇒ *page 187* if the vehicle is not completely inside the parking space or if the vehicle tries to drive over the parking space barrier.

Exiting parking spaces with the myAudi app¹⁾²⁾

Applies to: vehicles with remote park assist plus

Starting the parking space exiting process

- ▶ Start the myAudi app.
- ▶ Start the engine in the myAudi app soon. When starting, the vehicle key and mobile device must not be more than approximately 10 feet (3 m) away from the vehicle.
- ▶ Start the process of exiting the parking space with the mobile device soon. Otherwise, the function will be canceled.
- ▶ Pay attention to the path of the vehicle. If the traffic situation permits, drive the vehicle out of the parking space using the mobile device ⇒ . The vehicle key and the mobile device cannot be more than approximately 20 feet (6 m) away from the vehicle during remote controlled parking.
- ▶ In unclear situations, pause the process of exiting the parking space using the mobile device. For example, this may be necessary if an obstacle appears or if the vehicle comes very close to an obstacle.
- ▶ To resume the process of exiting the parking space, start it again on the mobile device. The rest of the process of exiting the parking space ▶

1) System availability may be limited depending on the market.

2) The function or equipment that is described was in development at the time this manual was published and may not be available in your vehicle.

will be recalculated based on the vehicle position.

Unexpected interruption when exiting the parking space

- ▶ If the process of exiting the parking space is interrupted unexpectedly because of the vehicle key, change your location together with the mobile device and vehicle key and resume the process of exiting the parking space.

End of the parking space exiting process

If an obstacle appears, stop the process of exiting the parking space ⇒ *page 187*.

The process for exiting a parking space ends when the maximum distance is reached or if additional corrective movements are no longer necessary. Unlock and resume manual control of the vehicle.

WARNING

- Observe the safety precautions and note the limits of the assist systems, sensors, and cameras ⇒ *page 127* to ⇒ *page 130*.
- Failing to pay careful attention to the vehicle's surroundings increases the risk of an accident. Park your vehicle with the mobile device only if you are sure that no obstacle is in the vehicle's path or under the vehicle, and that no obstacles will move into the vehicle's path.

Interrupting remote controlled parking¹⁾²⁾

Applies to: vehicles with remote park assist plus

To stop the vehicle, you can temporarily pause remote controlled parking at any time using your mobile device.

You can also completely stop the process of exiting the parking space and come to full stop immediately using the vehicle key by pressing any button on the vehicle key. Therefore, always keep

the vehicle key with you during the remote controlled parking process.

Canceling automatically

The remote controlled parking will be canceled automatically in the following situations, among other things:

- If the myAudi app is not started soon after exiting the vehicle
- You switch off the system
- The time limit is exceeded
- The ESC intervenes

Taking over the process of parking or exiting a parking space

After canceling the process of parking or exiting a parking space, the vehicle will come to a stop and the "P" selector lever position will be engaged. Take over control of the vehicle, manually end the process of parking or exiting a parking space, and safely park the vehicle. You can also restart the entire process of parking or exiting a parking space from inside the vehicle.

WARNING

- Observe the safety precautions and note the limits of the assist systems, sensors, and cameras ⇒ *page 127* to ⇒ *page 130*.
- Failing to pay careful attention to the vehicle's surroundings increases the risk of an accident. Park your vehicle with the mobile device only if you are sure that no obstacle is in the vehicle's path or under the vehicle, and that no obstacles will move into the vehicle's path.

Tips

The process of parking or exiting a parking space will be interrupted temporarily if an obstacle is detected.

¹⁾ System availability may be limited depending on the market.

²⁾ The function or equipment that is described was in development at the time this manual was published and may not be available in your vehicle.

Maneuver assist

Description

Applies to: vehicles with maneuver assist



Fig. 140 Upper display: maneuver assist

General information

The maneuver assist offers support when maneuvering and parking by monitoring the area in front of, behind, and beside the vehicle using sensors. If there is an impending collision with an object, the system will intervene within its limits and attempt to prevent the collision by applying the brakes. The system can detect objects that are approximately 8 inches (20 cm) high or higher.

Display overview

The displays ① - ④ indicate the status and availability of the maneuver assist.

- ① The white border indicates the availability in this area.
- ② The red border indicates an object nearby.
- ③ If there is no border, this indicates an inactive area (partial availability).
- ④ Activate/deactivate maneuver assist and status displays:
 - Maneuver assist activated. The vehicle is bordered in white. If the sensors are partially available, the white border will only be visible in the monitored areas.
 - Maneuver assist is temporarily deactivated.
 - (symbol shown in gray) Maneuver assist is not available.
 - No symbol: maneuver assist was switched off completely in the settings.

Braking intervention

Braking intervention can be initiated if there is an impending possible collision with a detected stationary object. If the brakes were applied until the vehicle stopped, the message **Maneuver assist: vehicle has been braked. Obstacle detected** will appear and you must take over control of the vehicle.

If you continue driving toward the obstacle after the vehicle is braked to a stop, maneuver assist will automatically be temporarily deactivated until the next maneuvering situation.

WARNING

Observe the safety precautions and note the limits of the assist systems, sensors, and cameras → [page 127](#) to → [page 130](#).

Tips

- If the indicator light blinks while driving, ESC will intervene to regulate and maneuver assist will be canceled.
- System functions may not be available if the ESC is limited or switched off, or if there is a malfunction.
- The system will not be available when certain assist systems are switched on or if park assist plus is used.

Activating or deactivating maneuver assist

Applies to: vehicles with maneuver assist

Requirements

- ▶ The maneuver assist is activated in the **Parking aid** menu → [page 131](#).
- ▶ The speed must not be higher than approximately 6 mph (10 km/h).



Automatic activation

Maneuver assist activates automatically when reverse gear is engaged while the engine is running.

Deactivating temporarily

If you do not want to use maneuver assist during a parking cycle, you can deactivate it temporarily. If maneuver assist is deactivated temporarily, it ▶



will be activated again automatically the next time park assist is activated.

- ▶ To deactivate maneuver assist temporarily, press  ⇒ *page 188, fig. 140* in the upper display. The  symbol will appear.

If you continue driving toward the obstacle after the vehicle is braked to a stop, maneuver assist will automatically be temporarily deactivated until the next maneuvering situation.

Activating manually

You can activate maneuver assist in various ways depending on the situation:

- ▶ To activate maneuver assist manually (such as when driving forward), press the  button in the center console.
- ▶ To reactivate maneuver assist after it has been deactivated temporarily, press  ⇒ *page 188, fig. 140* in the upper display. The  symbol will appear.

Switching on or off permanently

You can turn the maneuver assist on or off in the **Parking aid** menu ⇒ *page 131*.



If maneuver assist is switched off permanently, there will be no symbol in the center of the vehicle graphic  ⇒ *page 188, fig. 140*.

WARNING

Observe the safety precautions and note the limits of the assist systems, sensors, and cameras ⇒ *page 127* to ⇒ *page 130*.

Messages

Applies to: vehicles with maneuver assist

If  or  is displayed when there is a malfunction, the maneuver assist functions may be unavailable or may be limited.

A message that indicates the cause and possible solution may appear with some displays. The weather conditions may be too poor or a sensor may be covered. Clean the area in front of the sensors and cameras ⇒ *page 130* and try to turn the system on again later.

If the malfunction remains, drive to an authorized Audi dealer or authorized Audi Service Facility immediately to have the malfunction corrected.

Telephone

Introduction

Applies to: vehicles with telephone

You can operate various telephone functions easily through the MMI in your vehicle.

Depending on the country and the vehicle equipment, the following options may be available:

- Connecting a cell phone with Bluetooth
- Using two telephones
- Using the Audi phone box
- Using the Rear Seat Remote

WARNING

- Medical experts warn that mobile devices can interfere with the function of pacemakers. Always maintain a minimum distance of about 7.9 inches (20 cm) between the mobile device antennas and the pacemaker.
 - Do not carry the mobile device in a pocket directly over the pacemaker when the phone is switched on.
 - Switch the mobile device off immediately if you suspect it may be interfering with the pacemaker.
- Do not use the voice recognition system* ⇒ *page 31* in emergencies because your voice may change in stressful situations. The system may take longer to dial the number or may not be able to dial it at all. Dial the emergency number manually.
- Switch your mobile device off in areas where there is a risk of an explosion. These locations are not always clearly marked. This may include gas stations, fuel and chemical storage facilities or transport vehicles, or locations where fuel vapors (such as propane or gasoline vapor in vehicles or buildings), chemicals or large quantities of dust particles (such as flour, sawdust or metal) may be present in the air. This also applies to all other locations where you would normally switch your engine/motor off.
- The demands of traffic require full attention of all road users. Always read the chapter ⇒ *page 22, Traffic safety information.*

Note

Read the information about Audi connect, and be sure to note the connectivity costs section ⇒ *page 203.*

Tips

- The Bluetooth connection range is limited to inside the vehicle.
- A selection of supported Bluetooth devices can be found in the database for tested mobile devices at www.audi.com/bluetooth.

Setup

Connecting a mobile phone via Bluetooth

Applies to: vehicles with telephone

Requirement: the vehicle must be stationary and the ignition must be switched on. The Bluetooth settings must be open on your mobile device during the connection setup. The mobile device to be connected must not be actively connected to any other Bluetooth device. The MMI must only be connected to one mobile device.

- ▶ Enable the Bluetooth function and visibility on the MMI ⇒ *page 247* and the mobile phone.
- ▶ Applies to: MMI: Select on the home screen: **PHONE**.
- ▶ Applies to: Rear Seat Remote: Select on the home screen: **PHONE** > **Connect device** > ⊕.
- ▶ Follow the system instructions. The available Bluetooth devices will be displayed after several seconds.
- ▶ Press on the desired mobile device in the list of displayed Bluetooth devices.
- ▶ To update the list, press ↻.

A PIN for a secure Bluetooth connection will be generated.

- ▶ Confirm the PIN on your mobile device.
- ▶ Follow the system instructions.
- ▶ Follow any additional system prompts in the MMI or on the Rear Seat Remote* and on your mobile phone. ▶

After connecting successfully

The cell phone contacts are automatically loaded in the MMI. This process can take several minutes, depending on the number of contacts.

Applies to: vehicles with Rear Seat Remote: To have contacts and call details displayed only on the Rear Seat Remote display, activate privacy mode ⇒ *page 195*/⇒ *page 199*.

Depending on your cell phone and the connection type, you can use the following functions in the MMI:

Using the hands-free system

Requirement: your cell phone must be connected to the MMI via a Bluetooth Hands Free Profile (Bluetooth HFP).

You can use the hands-free system. You can make calls using the antenna on your mobile device.

Sending and receiving messages

See ⇒ *page 200*.

Tips

- Pay attention to any system prompts displayed on your mobile device or the MMI, for example if the system should connect automatically in the future. Depending on the mobile device, you may need to download contacts and confirm access to your messages separately.
- You can also search for the MMI on your mobile device using the Bluetooth device search.
- You only have to pair your device one time. Bluetooth devices that are already paired automatically connect to the MMI when the Bluetooth function is switched on, when they are within range, and when the ignition is switched on. The last connected mobile device is given first priority.
- You can manage additional settings for connected mobile devices in the Connected devices menu ⇒ *page 247*.
- When leaving the vehicle, the Bluetooth connection to the mobile device will automatically disconnect. Depending on your

mobile device, phone calls in progress may be automatically redirected from the MMI to your mobile device so that you can continue the call on your phone.

Using two telephones

Applies to: vehicles with telephone

You can connect two mobile phones to the MMI at the same time using the Bluetooth HFP, for example a business phone and a private phone. You can be reached in your vehicle through both mobile phones.

Applies to: mobile devices with Bluetooth Message Access Profile (MAP): You can send and receive messages with both mobile devices ⇒ *page 200*.

Connecting another mobile device

Requirement: a mobile device must be connected to the MMI, and displayed in the Rear Seat Remote* if available. The vehicle must be stationary and the ignition must be switched on. The Bluetooth settings must be open on your mobile device during the connection setup. The mobile device to be connected must not be actively connected to any other Bluetooth device.

- ▶ Enable the Bluetooth function and visibility on the MMI ⇒ *page 247* and the mobile phone.
- ▶ Applies to: MMI: Select on the home screen: **PHONE** > , or
- ▶ Applies to: MMI: Select on the home screen: **SETTINGS** > **Connected devices** > **Telephone 1** or **Telephone 2** > **New connection**.
- ▶ Applies to: Rear Seat Remote: Select on the home screen: **SETTINGS** >  > **Connect device**.
- ▶ Follow the system instructions. The available Bluetooth devices will be displayed after several seconds.
- ▶ Press on the desired mobile device in the list of displayed Bluetooth devices.
- ▶ To update the list, press .

A PIN for a secure Bluetooth connection will be generated.

- ▶ Confirm the PIN on your mobile device.
- ▶ Follow the system instructions. ▶

- ▶ Follow any additional system prompts in the MMI or on the Rear Seat Remote* and on your mobile phone.

After connecting successfully

See ⇨ *page 191, After connecting successfully.*

Switching between two mobile devices

Requirement: phone 1 and phone 2 must be connected to the MMI, and displayed in the Rear Seat Remote* if available.

- ▶ Applies to: MMI/Rear Seat Remote: Select on the home screen: **PHONE** > 

Note

Read the information about Audi connect, and be sure to note the connectivity costs section ⇨ *page 203.*

Disconnecting a mobile device

Applies to: vehicles with telephone

- ▶ To disconnect a Bluetooth device from the MMI, use the Connected devices menu ⇨ *page 248.*

Using the Audi phone box

General information

Applies to: vehicles with Audi phone box/Audi phone box light

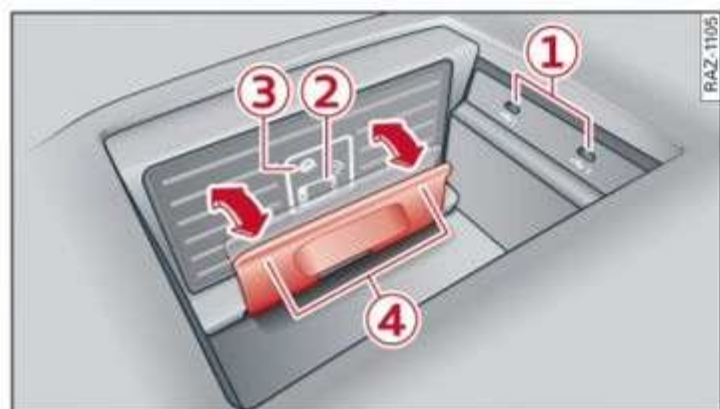

Fig. 141 Storage compartment under the center armrest: Audi phone box with holder* and connections

Depending on vehicle equipment, you may be able to use the following functions with the Audi phone box:

- Make phone calls using the vehicle's exterior antenna
- Charge a mobile device using the USB input

- Charge a mobile device wirelessly
- Reminder signal

Limitations

In some situations, the functions of the Audi phone box may be limited or temporarily unavailable. For example, this may happen if

- There is one more than mobile device in the Audi phone box
- The mobile device is located in a bag or a protective case
- There are objects between the Audi phone box and the mobile device
- The mobile device is not positioned in the center of the Audi phone box

WARNING

- Loose objects can be thrown around the vehicle interior during sudden driving or braking maneuvers, which increases the risk of an accident. Store objects securely while driving.
- Do not allow the visual or audio signals from a mobile device to distract you from traffic, because this increases the risk of an accident. Operate the mobile device only via the MMI. Fold the center armrest down while driving.

Note

Applicable to U.S.A.

Operation of the Audi phone box is subject to the following requirements of the Federal Communications Commission:

- This is a CONSUMER device.
- BEFORE USE, you MUST REGISTER THIS DEVICE with your wireless provider and have your provider's consent. Most wireless providers consent to the use of signal boosters. Some providers may not consent to the use of this device on their network. If you are unsure, contact your service provider.
- You MUST operate this device with approved antennas and cables as specified by the manufacturer. Antennas MUST be installed at least 20 cm (8 inches) from any person. ▶

- You **MUST** cease operating this device immediately if requested by the FCC or a licensed wireless service provider.
- **WARNING:** E911 location information may not be provided or may be inaccurate for calls served by using this device.

Note

Applicable to Canada

In Canada, operation of a Zone Enhancer, such as an Audi phone box, is subject to the following requirements of the Innovation, Science and Economic Development Canada (ISED):

- This is a **CONSUMER** device.
- **BEFORE USE**, you **MUST** meet all requirements set out in **CPC-2-1-05**. At the time of printing this user manual, the CPC-2-1-05 client procedures circular of ISED Canada was available at the following web page: <http://www.ic.gc.ca/eic/site/smt-gst.nsf/eng/sf08942.html>.
- You **MUST** operate this device with approved antennas and cables as specified by the manufacturer. Antennas **MUST NOT** be installed within 20 cm of any person.
- You **MUST** cease operating this device immediately if requested by ISED or a licensed wireless service provider.
- **WARNING:** E911 location information may not be provided or may be inaccurate for calls served by using this device.

Tips



The system complies with United States FCC regulations and ISED regulations ⇒ *page 325*.

Making phone calls using the exterior antenna

Applies to: vehicles with Audi phone box

With the Audi phone box, you can make calls using the exterior antenna on the vehicle. Using the exterior antenna helps when there is a low signal and also provides better reception quality.

Requirement: the ignition must be switched on.

- ▶ Fold open the holder  ⇒ *page 192, fig. 141* in the Audi phone box.
- ▶ To make phone calls through the vehicle's exterior antenna using your mobile device, lay your device with the rear side against the phone symbol  in the center of the Audi phone box and holder .

Charging the battery using the USB input

Applies to: vehicles with Audi phone box/Audi phone box light

You can charge your mobile device using a special USB adapter with the Audi phone box ⇒ *page 233*.

Requirement: the ignition must be switched on.

- ▶ To charge your mobile device via USB, connect it to the USB input  ⇒ *page 192, fig. 141*.

Tips





- You can purchase a USB adapter from an authorized Audi dealer or authorized Audi Service Facility, or at specialty stores.
- Audi recommends using Audi Genuine Accessories. Audi has verified their reliability, safety, and suitability.

Charging a mobile device wirelessly

Applies to: vehicles with Audi phone box/Audi phone box light

You can charge your mobile device wirelessly using the Audi phone box.

Requirement: the ignition must be switched on. Your mobile device must meet the Qi standard.

- ▶ Make sure that the wireless charging function is switched on:
- ▶ Applies to: MMI: Select on the home screen: **SETTINGS > General > Reminder signal and mobile device charging**.
- ▶ Switch the **Mobile device wireless charging** function on.
- ▶ Fold open the holder  ⇒ *page 192, fig. 141* in the Audi phone box.
- ▶ To charge your mobile device wirelessly, lay your device with the rear side against the  symbol  between the Audi phone box and holder .

⚠ WARNING

- The mobile device may become hot during wireless charging. Pay attention to the temperature of your mobile device and be careful when removing it from the Audi phone box.
- An alternating magnetic field is used for wireless charging. Maintain a minimum distance of approximately 2.4 inches (6 cm) to the Audi phone box charging plate. The thresholds for prolonged exposure at this distance comply with ICNIRP1998. Therefore, interactions such as irritation of sensory organs, malfunctions of active medical implants (such as pacemakers, infusion pumps, or neurostimulators) or effects on passive medical implants (such as prosthetic limbs) is highly unlikely. If you have a medical implant, seek medical advice from a specialist if you have any questions. You can also switch the function for wireless charging in the Audi phone box on and off. You can continue to charge your mobile device using a cable connection.

i Tips

- The maximum charging output is 5 W.
- The charging time and temperature will vary depending on the mobile device being used.

Mobile device reminder signal

Applies to: vehicles with Audi phone box/Audi phone box light

When the device reminder signal is switched on, you will be notified that your mobile device is still in the Audi phone box when you leave the vehicle.

Requirement: your mobile device must be located in the Audi phone box (if Qi-capable) or connected to the USB port with charging function using a USB adapter, and the smartphone interface must be active or your iPhone must be connected to the MMI via Bluetooth and charging using a USB adapter connected to the USB port with charging function.

- ▶ Applies to: MMI: Select on the home screen: **SETTINGS > General > Reminder signal and mobile device charging.**

The following settings may be available, depending on vehicle equipment:

- **Signal tone**
- **Off**

Spoken cue

this setting is switched on at the factory.

Mobile device notes: reminder, charge level

When this function is switched on, the charge status of your mobile device is displayed. You will also be reminded not to forget your mobile device when leaving the vehicle.

Using the Rear Seat Remote**General information**

Applies to: vehicles with Rear Seat Remote

You can use many phone functions with the Rear Seat Remote. You can only adjust settings, such as Bluetooth settings for connecting with the mobile phone, in the MMI.

Making phone calls using the Rear Seat Remote

Applies to: vehicles with Rear Seat Remote

You can connect two mobile devices to the MMI and use them to make phone calls with the Rear Seat Remote.

Using the hands-free system

To use the Rear Seat Remote hands-free system, connect your cell phone to the MMI using the Bluetooth HFP.

Using the Bluetooth headset*

Requirement: your Bluetooth headset* must be connected to the MMI ⇨ *page 247*.

To conduct phone calls from the Rear Seat Remote through the connected Bluetooth headset*, activate **Call acceptance**.

- ▶ Applies to Rear Seat Remote: select on the home screen: **SETTINGS > Telephone.**
- ▶ Switch the **Call acceptance** function on.

Displaying connected devices

Applies to: vehicles with Rear Seat Remote

- ▶ Applies to: Rear Seat Remote: Select on the home screen: **DEVICES**. The list of all devices already connected will be displayed.
- ▶ Press a mobile device in the list of devices already connected. The status in each category will be shown:
 - **Connected/Not connected**
 - **Private mode on/Private mode off**
 - **Favorite/Not a favorite**

Manage connected devices

Applies to: vehicles with Rear Seat Remote

Requirement: the **DEVICES** menu must be displayed.

Connecting a device

Requirement: the Bluetooth settings must be open on your mobile device during the connection setup. The Bluetooth function and visibility of the MMI and mobile device must be switched on. The mobile device to be connected must not be actively connected to any other Bluetooth device. The Rear Seat Remote can be connected to a maximum of one mobile device through the MMI.

- ▶ To search for and connect your mobile device, press ⊕ ⇒ *page 190, Connecting a mobile phone via Bluetooth.*

Selecting a connected device

- ▶ Press on a Bluetooth device that is not connected.
- ▶ Press **Not connected**. The selected Bluetooth device is connected.

Disconnecting a connected device

- ▶ Press on a connected Bluetooth device.
- ▶ Press **Connected**. The selected Bluetooth device is disconnected.

Deleting a device

- ▶ Press on a Bluetooth device.
- ▶ Press **Delete**.

Activating private mode

- ▶ Press on a connected Bluetooth device.
- ▶ To allow contacts and call details to only be displayed on the Rear Seat Remote display, press **Private mode off**. The private mode will be activated.

Storing a device as a favorite

- ▶ Press on a connected Bluetooth device.
- ▶ To set a Bluetooth device as a favorite, press **Not a favorite**.

When the mobile device is in range and the Bluetooth function on the mobile device and in the MMI is switched on, the default phone will be given priority over the other Bluetooth devices and will be connected directly to the Rear Seat Remote.

Using the telephone

Accessing the telephone functions

Applies to: vehicles with telephone



Fig. 142 Upper display: selection menu

Requirement: a mobile device must be connected to the MMI.

- ▶ Applies to: MMI/Rear Seat Remote: Select on the home screen: **PHONE**.

Possible telephone functions:

①	Search	
②	Call list	196
③	Favorites	196
④	Contacts	196
⑤	Voicemail	197
⑥	Dial phone number	197
⑦	Switch telephones	199

Managing call lists

Applies to: vehicles with telephone



Fig. 143 Upper display: call list

Opening the call list

- Applies to: MMI/Rear Seat Remote: Select on the home screen: **PHONE** > **Call list**.

Opening call lists using the multifunction steering wheel

- Select in the instrument cluster: Telephone tab > button > **Call list**.

Possible call list symbols:

- ① Missed calls
- ② Dialed numbers
- ③ Accepted calls
- ④ Editing a telephone number
- ⑤ Display business card 197
- ⑥ Number of interactions with a contact

If more than one interaction with a contact or number has taken place, the last one is displayed in the form of an arrow ①, ②, or ③.

Call list options

Press and hold a contact or a phone number in the list until the **Options** menu appears.

Depending on the vehicle equipment and your mobile phone, the following options may be available:

- **Save as a shortcut** ⇨ page 26, *Shortcuts*.
- **Store as favorite** ⇨ page 196.
- **Send a text** ⇨ page 200.
- **Send e-mail** ⇨ page 201.

Edit number

Edit a phone number before dialing it.

Show history

Requirement: you must have had more than one interaction with a contact.

All interactions with a contact or a number are displayed.

Managing favorites

Applies to: vehicles with telephone

You can store contacts for all connected mobile devices as shortcuts in the favorites list.

Accessing favorites

- Applies to: MMI/Rear Seat Remote: Select on the home screen: **PHONE** > **Favorites**.

Opening favorites using the multifunction steering wheel

- Select in the instrument cluster: Telephone tab > button > **Favorites**.

Storing favorites

- Press ⇨ page 197 in the business card, or
- Press **Store as favorite** in the options ⇨ page 196.

Deleting favorites

- Press ⇨ page 197 in the business card, or
- Select: **Favorites** > > *one or multiple favorites* or **Select all** > **Delete** > **(Done)**.

Tips

The favorites can only be edited via the MMI.

Managing the directory

Applies to: vehicles with telephone

You can manage up to four directories in the MMI.

Requirement: a mobile device must be connected to the MMI.

Opening the directory

- Applies to: MMI/Rear Seat Remote: Select on the home screen: **PHONE** > **Contacts**.

The contacts will be displayed. You can change the sort order ⇨ page 200, **Sort order**.

Deleting imported contacts

Requirement: you must have imported at least one contact ⇒ *page 200*.

- ▶ Select: **Contacts** >  > *one or more text messages* > **Delete** > **(Done)**. The imported contacts are deleted.

Directory options

- ▶ Press and hold a contact in the directory until the **Options** menu appears.

Depending on the vehicle equipment and your mobile phone, the following options may be available:

- **Store as favorite** ⇒ *page 196*.
- **Send contact**: you can select **Text message** or **E-mail** ⇒ *page 200*.
- **Send a text** ⇒ *page 200*.
- **Send e-mail** ⇒ *page 201*.
- **Save as a shortcut** ⇒ *page 26, Shortcuts*.



Tips

- Pay attention to any synchronization prompts on your mobile device when downloading contacts.
- The contacts from the mobile device may not be transferred in alphabetical order. If there are too many entries, contacts with different first letters may be missing in the MMI.
- Only the contacts from the active connected mobile device are displayed.
- The contacts in the local MMI memory are always visible and can be accessed by other persons.
- After switching off the ignition and exiting the vehicle, the mobile device directory will be updated when the MMI is started again if the mobile device is within range and the Bluetooth function is switched on in the mobile device and the MMI.
- Only the contacts in the local MMI memory can be deleted.



Opening business cards

Applies to: vehicles with telephone

The business card shows you details about a contact.

- ▶ To open a business card, press on a contact in the directory, or
- ▶ Press  in the call list  ⇒ *page 196, fig. 143*.

Possible options in the business card:

- ▶ **Call**: press on a phone number.
- ▶ **Storing a favorite**: press .
- ▶ **Deleting a favorite**: press .
- ▶ **Sending a text message**: press .
- ▶ **Starting navigation**: press on an address.
- ▶ **Sending an e-mail**: press on an e-mail address.
- ▶ **Send contact**: you can select **Text message** or **E-mail** ⇒ *page 200*.
- ▶ **Save as a shortcut** ⇒ *page 26, Shortcuts*.

Listening to voicemail

Applies to: vehicles with telephone

Calling voicemail

- ▶ Applies to: MMI/Rear Seat Remote: Select on the home screen: **PHONE** > **Voicemail**.

Entering the voicemail number

Requirement: there must be no voicemail number stored.

- ▶ Enter the desired number.
- ▶ Press **OK**.

Dialing the voicemail number

Requirement: a voicemail number must be stored.

- ▶ Press **Voicemail**. The call begins immediately.

Tips

This service must be set up and activated by the mobile phone service provider.

Dialing a telephone number

Applies to: vehicles with telephone

Depending on the vehicle equipment, you may have the following options for dialing a phone number: ▶

- Using text input in the MMI ⇒ *page 27*.
- Using voice operation ⇒ *page 31*.
- by text input through the Rear Seat Remote ⇒ *page 27*.

Call options

Applies to: vehicles with telephone

- ▶ To accept or end a call, press the  button on the multifunction steering wheel. Operating ⇒ *page 16* and ⇒ *page 33*.

Depending on vehicle equipment and your mobile device, the following options may be available in the MMI or in the Rear Seat Remote when there is an incoming call:

- **Answer**
- **Handsfree**
- **Headset**
- **Decline**
- **Message**

If you exit the vehicle during a phone call, the Bluetooth connection will be disconnected. Depending on your mobile device, phone calls in progress may be automatically transferred from the MMI to your mobile device.

Tips

The radio or media playback is muted during a phone call.

During a phone call

Applies to: vehicles with telephone

Depending on your mobile device and the type of connection, the following options may be available during a call:

- **End call**
- **Mute**

Sending a tone sequence

Press **Numbers**. You can enter tone sequences (DTMF) and send them to the other party on the call.

Hold

Puts the current call on hold. To resume the call, press **Resume**.

Answering an incoming call

One of these options will be available, depending on the mobile phone service provider:

- **Answer**: the current phone call will be put on hold. The incoming call will be answered.
- **Replace**: the active call will be replaced with the incoming call.

Declining an incoming call

If you select **Decline**, the incoming call will be declined.

Conference

Requirement: two phone calls must be in progress.

Depending on your mobile phone service provider, you can add a call on hold and up to five active callers to a conference call.

Swap call

Requirement: two phone calls must be in progress.

You can alternate between two phone calls.

Additional call options

Press **More**.

Depending on the mobile device being used and the type of connection, the following options may be available:

Transfer call to mobile device

Transfer the current call to your mobile device or Bluetooth headset*.

Switch to hands-free

Applies to: MMI

Transfer the current call from your mobile device to the MMI.

Add call

You can start a new call. The current call will be put on hold.

Remove conference member

You can remove conference call members individually when a conference call is active. ▶

Microph. input

Applies to: MMI

You can adjust the input level of the microphone using the slider.

Tips

The call waiting function must be activated in your mobile device to be alerted about an incoming call during an active call.

Making an emergency call

Applies to: vehicles with telephone

Requirement: a mobile device must be connected to the MMI.

- ▶ Applies to: MMI: Select on the home screen: **PHONE > Dial phone number > the local emergency call number (for example, 911) > Dial.**
- ▶ Applies to: /Rear Seat Remote: Select on the home screen: **PHONE > Dial number > the local emergency call number (for example, 911) > Handsfree/Headset*.**

WARNING

- Because your phone works with radio signals, a connection cannot be guaranteed under all circumstances. Do not rely on only your phone when it comes to essential communication (such as during a medical emergency).
- Always follow the instructions given by the emergency personnel during an emergency call and only end the call when they instruct you to do so.

Settings

Telephone settings

Applies to: vehicles with telephone

- ▶ Applies to: MMI: Select on the home screen: **PHONE > .**

The following options may be possible, depending on your mobile device:

- **Decline with text message**
- **Edit voicemail number**

Switching between two mobile devices

Requirement: phone 1 and phone 2 must be connected to the MMI.

Switch telephones: the device name of the available mobile device is displayed. You can switch the phone by pressing the button.

Private mode: call lists only in Rear Seat Remote

Applies to: vehicles with Rear Seat Remote

To allow contacts and call details to only be displayed on the Rear Seat Remote display, activate private mode.

Ringtone and volume settings

- **Ringtone and message volume:** you can adjust the volume using the slider.
- **Ringtone:** select a ringtone from the list.
- **Microphone input level:** you can adjust the input level of the microphone using the slider.

Data module serial number (IMEI)

Applies to: vehicles with data module

The serial number (IMEI) will be displayed.

Contact settings

Applies to: vehicles with telephone

- ▶ Applies to: MMI: Select on the home screen: **PHONE > Contacts > .**

Switching between two mobile devices

Requirement: phone 1 and phone 2 must be connected to the MMI.

Switch telephones: the device name of the available mobile device is displayed. You can switch the phone by pressing the button.

The directory for the selected phone will be displayed.

Hide grayed-out contacts

When this function is switched on, contacts that have no phone numbers stored for them will be hidden. ▶

Sort order

You can sort the contacts by **Last name** or **First name**.

Download contacts

Requirement: a mobile device must be connected to the MMI.

To update the contacts in the MMI, you can manually download your mobile device contacts. Depending on the mobile device, you may need to disconnect and reconnect the Bluetooth connection to update the contacts.

Importing and exporting contacts

Requirement: a USB storage device is connected to a USB port with charging function ⇒ *page 233*.

Contacts in vCard format (.vcf) can be imported or exported from the MMI.

- **Importing contacts from a storage device:** Requirement: the USB storage device must contain contacts in the vCard format. They must not be located in sub-folders. Select: > **Search for import data** > **USB device 1/USB device 2** > *desired contacts* or **Select all** > **Start import**.
- **Exporting contacts to a storage medium:** Requirement: you must have a contact imported. Select: **Export contacts** > **Find exporting source** > **USB device 1/USB device 2** > *desired contacts* or **Select all** > **Start export**.

Tips

- The imported contacts are stored in the local MMI memory.
- There should be no other files or folders on the storage medium containing the contacts to be imported.
- Contacts that were downloaded from a mobile device cannot be exported.
- Apple devices and MTP devices (such as smartphones) are not recognized as USB storage devices.

Messages

Text messages

Applies to: vehicles with telephone

Requirement: your mobile device must be connected to the MMI via Bluetooth Message Access Profile (Bluetooth MAP).

- ▶ Applies to: MMI: Select on the home screen: **MESSAGES** >  > **Text message (telephone 1)/Text message (telephone 2)**.

The following functions are available:

- **New text message***
- **Inbox**
- **Sent**
- **Outbox***
- **Drafts***
- **Deleted**

User defined*

If necessary, user-defined folders will be copied to your mobile device.

Message options

Press on a text message.

Depending on the country, the following options may be available:

- **Read out**
- **Reply**
- **Forward**
- **More**

To switch between messages, press < or >.

Press **More**. Depending on your mobile device and the selected mailbox, additional options may be available:

- **Call**
- **Forward**
- **Navigate**
- **Extract numbers**
- **Send again**

Settings

Press .

New text message notification

When the function is switched on, an envelope  in the MMI status bar will indicate when there is a new text message.

Tips

Only new received messages may be displayed depending on your mobile device.

E-mail

Applies to: vehicles with telephone and e-mail

Requirement: your mobile device must be connected to the MMI via Bluetooth Message Access Profile (Bluetooth MAP).

- ▶ Applies to: MMI: Select on the home screen: **MESSAGES** >  > **E-mail (telephone 1)/E-mail (telephone 2)**.

The following functions are available:

- **New e-mail**
- **Inbox**
- **Sent**
- **Outbox**
- **Drafts***
- **Deleted***

User defined*

If necessary, user-defined folders will be copied to your mobile device.

Message options

Press on an e-mail.

Depending on the country, the following options may be available:

- **Read out**

Troubleshooting

Applies to: vehicles with telephone

The information that follows lists some troubleshooting options. They depend on the equipment. ▶

- **Reply**
- **Reply to all**
- **Forward**
- **More**

To switch between messages, press < or >.

Press **More**. Depending on your mobile device and the selected mailbox, additional options may be available:

- **Call**
- **Forward**
- **Extract e-mail**
- **Navigate**
- **Extract numbers**
- **Show all recipients**
- **Send again**

Settings

Press .

New e-mail notification

When the function is switched on, an envelope  in the MMI status bar will indicate when there is a new e-mail.

Note

Read the information about Audi connect, and be sure to note the connectivity costs section ⇒ *page 203*.

Tips

Only new received messages may be displayed depending on your mobile device.

Problem	Solution
<p>Pairing the mobile device to the MMI failed.</p>	<p>Make sure the requirements for connecting a mobile phone have been met ⇒ <i>page 190</i>, or make sure you did not accidentally decline the PIN for establishing a connection on your mobile phone. If necessary, repeat the pairing process ⇒ <i>page 190</i>.</p>
<p>After pairing, not all contacts or no contacts have been loaded into the MMI.</p>	<p>Avoid using special characters in names. Avoid using contact groups on your mobile device. Check for prompts on your mobile device when connecting via Bluetooth.</p> <p>Applies to: vehicles with Rear Seat Remote: Check if private mode is active ⇒ <i>page 195</i>/⇒ <i>page 199</i>.</p>
<p>Certain telephone functions are grayed out or not available.</p>	<p>The telephone functions depend on the mobile device service provider and the mobile device you are using.</p>
<p>Some telephone functions may be switched off or not available, even though the mobile device is supported.</p>	<p>Check if the Bluetooth settings on your cell phone are limited or individual Bluetooth settings are deactivated. This may be the case with business cell phones.</p>
<p>The MESSAGES menu is not available.</p>	<p>Make sure your mobile device has an option to show messages option and that it is enabled.</p>
<p>Wireless cell phone charging is not working or is interrupted.</p>	<p>Check if wireless charging with the Audi phone box is switched on. Check if your mobile device is Qi-capable. Make sure your mobile device is positioned correctly in the Audi phone box ⇒ <i>page 192</i> and that there are no objects located between the phone box and the phone.</p>

Audi connect

General information

Applies to: vehicles with Audi connect

Depending on the country and the vehicle equipment, the following functions may be available:

- Audi connect Infotainment
- Audi connect vehicle control
- Audi connect apps

WARNING

- To reduce the risk of an accident, only use Audi connect services and the Wi-Fi hotspot only if the traffic situation permits it. Read and follow the guidelines provided in ⇒ *page 22, Traffic safety information*.
- It is only safe to use tablets, laptops, mobile devices and other similar devices when the vehicle is stationary because, like all loose objects, they could be thrown around the inside of the vehicle in a crash and cause serious injuries. Store these types of devices securely while driving. Also read the warnings in the chapter ⇒ *page 81*.

Note

- Applies to: embedded SIM card usage: The connection costs for Audi connect Infotainment services are included in the price of Audi connect Infotainment during the subscription period with some exceptions. Please note that there may be additional charges when using some services. For example, this applies to online radio/podcasts, additional online data, or for Internet connections and services that use the Wi-Fi hotspot. Depending on the country, data plans may need to be purchased for these Internet connections and services ⇒ *page 208*. For additional information, see my.audi.com.
- Applies to: use of your own SIM card in the cell phone via Wi-Fi: If you use your own SIM card, all data connections for all Audi connect Infotainment services will run through your SIM card. This could result in additional costs, depending on your cell phone service

provider and especially when using in other countries. A flat rate data plan is strongly recommended. You can obtain more information from your cell phone service provider.

- In certain situations, the Wi-Fi hotspot data connection may be established as a replacement for the SIM card on your Wi-Fi device. This feature depends on the configuration of your Wi-Fi device and operating system. This could result in fees depending on your cell phone service provider, especially if you are using this feature while abroad. A flat rate data plan is strongly recommended. For more information, contact your cell phone service provider or refer to the owner's manual for your Wi-Fi device.
- You are responsible for all precautions taken for data protection, anti-virus protection, and protection against loss of data on mobile devices that are used, for example, to access the Internet through the Wi-Fi hotspot.
- In areas with poor GPS reception or outside the coverage range of the respective cell phone service provider, some functions and/or services may not be available, it may not be possible to send or receive data, or functionality may be limited.

Tips

- The availability of services depends on the subscription.
- Audi merely provides access to third party services through the MMI and does not assume any responsibility for the content and availability of these services.
- Use of the most up-to-date mobile network standard is not available in every country. Contact an authorized Audi dealer or authorized Audi Service Facility or your cell phone service provider for additional information.
- Availability, scope, providers, screen display, and costs of services may vary depending on the country, model, model year, end device and rates.

- All services/apps can be modified, activated/deactivated, renamed, and enhanced without further notification.
- Depending on the country and model there may be an app other than the “myAudi app” available for your vehicle. For additional information, see my.audi.com.

Audi connect Infotainment

Description

Applies to: vehicles with Audi connect Infotainment

With Audi connect Infotainment services, online information is transmitted directly to the vehicle.

An Internet connection is required to use Audi connect Infotainment. Depending on the country and vehicle equipment, the Internet connection can be established via an embedded SIM card (eSIM) or via your own SIM card in a cell phone using Wi-Fi.

WARNING

Always follow the information found in  in *General information on page 203*.

Note

Always follow the information found in  in *General information on page 203*.

Embedded SIM card

Applies to: vehicles with Audi connect Infotainment and an embedded SIM card

The data connection for Audi connect Infotainment services is made through an embedded SIM card (eSIM card) that is installed in the vehicle. You can use the Audi connect Infotainment services immediately.

Note

Always follow the information found in  in *General information on page 203*.

Using your own SIM card in a cell phone via Wi-Fi

Applies to: vehicles with Audi connect Infotainment and Wi-Fi

Depending on the country and the vehicle equipment, the MMI can connect to your own SIM card in a cell phone via a Wi-Fi connection and use it to establish an Internet connection \Rightarrow *page 204*.

Note

Always follow the information found in  in *General information on page 203*.

Connecting to Wi-Fi

Applies to: vehicles with Wi-Fi

The vehicle can use Wi-Fi to connect to a Wi-Fi hotspot.

Requirement: the ignition must be switched on.

- ▶ If necessary, switch on the “Wi-Fi hotspot (tethering)” function or the “personal hotspot” on your mobile device.
- ▶ Applies to: MMI: Select on the home screen: **SETTINGS > Connection settings > Wi-Fi**
- ▶ Switch on the Wi-Fi function.
- ▶ Press on the desired Wi-Fi hotspot from the list of available networks.
- ▶ Follow the system instructions.

The MMI has successfully connected to a Wi-Fi hotspot via Wi-Fi.

WARNING

Always follow the information found in  in *General information on page 203*.

Note

Always follow the information found in  in *General information on page 203*.

Tips

The system complies with United States FCC regulations and ISED regulations \Rightarrow *page 325*.

Using a Wi-Fi hotspot

Applies to: vehicles with Wi-Fi hotspot

You can connect up to eight Wi-Fi devices (such as smartphones) with the MMI Wi-Fi hotspot. If the MMI is connected to the Internet ⇒ *page 204*, the connected Wi-Fi devices can also use the MMI's Internet connection.

Requirement: the ignition must be switched on. Depending on the country, a data packet may be available ⇒ *page 208*.

- ▶ Applies to: MMI: Select on the home screen: **SETTINGS > Connection settings > Wi-Fi hotspot** Switch on the Wi-Fi hotspot.
- ▶ Applies to: MMI: Select on the home screen: **SETTINGS > Connection settings > Wi-Fi hotspot** The access data for the Wi-Fi hotspot is displayed.
- ▶ Switch the Wi-Fi function on in your mobile device and connect it to the MMI Wi-Fi hotspot using the authentication data that is shown.
- ▶ Follow any additional system prompts on your Wi-Fi device if necessary.

Your device is successfully connected with the MMI's Wi-Fi hotspot.

WARNING

Always follow the information found in ⇒  in *General information on page 203*.

Note

Always follow the information found in ⇒  in *General information on page 203*.

Tips

The system complies with United States FCC regulations and ISED regulations ⇒ *page 325*.

Audi connect Infotainment services

Configuration

Applies to: vehicles with Audi connect Infotainment

Some Audi connect Infotainment services must be configured through your personal myAudi ac-

count at my.audi.com before using them for the first time.

Tips

- A myAudi user must be logged in for some Audi connect Infotainment services.
- Some Audi connect Infotainment services must be activated at my.audi.com.
- Depending on the country, you may be able to use an Audi app or my.audi.com.
- For detailed information on configuration, visit my.audi.com.

Services

Applies to: vehicles with Audi connect Infotainment

Depending on the country and the vehicle equipment, the following services may be available:

Weather information

Applies to: MMI

- ▶ Press **WEATHER** on the home screen.



Editing settings: Select: **WEATHER** > .

- ▶ To display the weather for a location, press on a location in the list.
- ▶ To display the weather for your current location, press on the location that is marked with the crosshairs.

Requirement: route guidance must be active.

- ▶ To display the weather at your destination, press on the location that is marked with the flag .

Adding a location: select: **WEATHER** >  > **In a new city** > a location.

Removing a location: select: **WEATHER** >  >  > *one or more locations* or **Select all** > **Delete**.

Online news

- ▶ Applies to: MMI: Select on the home screen: **NEWS**.

Access to the calendar

Requirement: the myAudi app must be installed and open on your mobile device. Access to your calendar must be enabled on your mobile device. You must be logged into the myAudi app with your myAudi login data and you must have

selected your vehicle. The Wi-Fi function on your mobile device and the MMI must be enabled and your mobile device must be paired to the MMI Wi-Fi hotspot ⇒ *page 207, Wi-Fi hotspot.*

You can display the your mobile device calendar on the MMI.

- ▶ Applies to: MMI: Select on the home screen: **CALENDAR.**

WARNING

Always follow the information found in ⇒  in *General information on page 203.*

Note

Always follow the information found in ⇒  in *General information on page 203.*

Audi connect apps

Setup

Applies to: vehicles with Audi connect apps

You must be logged in to the vehicle as a myAudi user to use Audi connect apps.

- ▶ Create a myAudi account by registering in the myAudi app.
- ▶ Add your vehicle to your myAudi account and then verify your myAudi account using one of the verification processes provided.
- ▶ Add the myAudi user to your vehicle.

WARNING

Always follow the information found in ⇒  in *General information on page 203.*

Note

Always follow the information found in ⇒  in *General information on page 203.*

Apps

Applies to: vehicles with Audi connect apps

Requirement: you must be logged in to your vehicle with your myAudi user.

STORE

You can search and install apps for your vehicle.

WARNING

Always follow the information found in ⇒  in *General information on page 203.*

Note

Always follow the information found in ⇒  in *General information on page 203.*

Audi connect vehicle control services

Services

Applies to: vehicles with Audi connect vehicle control

Using Audi connect vehicle control services, you can perform tasks such as viewing data about your vehicle or control vehicle functions remotely.

You can view and use services available for your vehicle at my.audi.com or through the myAudi app.

Information about the services and the corresponding app was accurate at the time this manual was printed. The scope of services depends on the country and equipment. There may be changes over the service life of the vehicle.

WARNING

- Always follow the information found in ⇒  in *General information on page 203.*
- Driver messages, text messages, and illuminated warning and indicator lights in the vehicle always take priority over information from the Audi connect services. The information displayed by the Audi connect services should not cause you to take safety risks. This can result in the vehicle breaking down in traffic and to serious injuries or accidents.

Tips

- Accessing specific data or controlling functions remotely depends on the charge level of the vehicle battery. Therefore, these functions only have limited availability after switching off the ignition.

- An eSIM card establishes the Internet connection for Audi connect vehicle control services. The costs for this are included in the price of Audi connect vehicle control services. The mobile phone network, for example, must be available to use these services.

Setup

Applies to: vehicles with Audi connect vehicle control

Create a myAudi account by registering in the myAudi app or at my.audi.com, depending on your country.

- ▶ Set the key user ⇒ *page 35*.
- ▶ Install the myAudi app on your mobile device and log in with your access information.

Tips

Some services require you to enter the 4-digit myAudi PIN that you set up during the registration process.

Settings

Wi-Fi

Applies to: vehicles with Wi-Fi

Requirement: the ignition must be switched on.

- ▶ Applies to MMI: Select on the home screen: **SETTINGS** > **Connection settings**.

Depending on the country and the vehicle equipment, the following functions may be available:

Wi-Fi

The MMI Wi-Fi is active when this function is switched on. The MMI can be connected to a Wi-Fi hotspot.

WARNING

Always follow the information found in ⇒  in *General information on page 203*.

Note

Always follow the information found in ⇒  in *General information on page 203*.

Wi-Fi hotspot

Applies to: vehicles with Wi-Fi hotspot

Requirement: the ignition must be switched on.

- ▶ Applies to MMI: Select on the home screen: **SETTINGS** > **Connection settings**.

Depending on the country and the vehicle equipment, the following functions may be available:

Wi-Fi hotspot

When the function is switched on, the MMI's Wi-Fi hotspot is active and Wi-Fi devices can be connected to the hotspot.

Wi-Fi hotspot settings

The Wi-Fi connection between the MMI and your Wi-Fi device is encrypted. You can change the following information if needed.

- **Access point (SSID):** name of the Wi-Fi hotspot.
- **Password:** an initial password was set at the factory in the MMI. Audi recommends changing the initial password. Only use secure passwords that conform to the general guidelines for secure passwords. Follow the system instructions.

Allow data connection through Wi-Fi

When the function is switched on, mobile devices can use the Internet connection through the Wi-Fi hotspot. Depending on the country, data packets may be required to do this.

WARNING

Always follow the information found in ⇒  in *General information on page 203*.

Note

Always follow the information found in ⇒  in *General information on page 203*.

Tips

The *name of the Wi-Fi hotspot* and the *Bluetooth name* are automatically compared when there are changes.

Data plans¹⁾

Applies to: vehicles with Audi connect

Data plans must be purchased in order to use certain services ⇨  in *General information on page 203*.

You can purchase data plans at my.audi.com.

 **WARNING**

Always follow the information found in ⇨  in *General information on page 203*.

 **Note**

Always follow the information found in ⇨  in *General information on page 203*.

 **Tips**

- Depending on the country, you may be able to use the myAudi app or my.audi.com.
- Depending on the country, there may be restrictions on the use of data plans (such as mobile phone service providers) when driving in other countries.
- If selling your vehicle, you should delete the vehicle from the customer portal for the cell phone service provider to avoid being charged for additional purchases.

Troubleshooting

Applies to: vehicles with Audi connect Infotainment

The information that follows lists some troubleshooting options. They depend on the equipment.

Problem	Solution
Audi connect Infotainment services: individual Audi connect Infotainment services are grayed out or not available.	Some Audi connect Infotainment services must be activated or configured through your personal myAudi account before using them for the first time. You can find detailed information online at my.audi.com .
Wi-Fi hotspot: it is not possible to connect through Wi-Fi.	Check if Wi-Fi is activated in the MMI ⇨ <i>page 207</i> . Delete all existing Wi-Fi connections on your mobile device and restart it.

¹⁾ Not available in every market.

Emergency call

Overview

Applies to: vehicles with emergency call function

An emergency call is a combination of data transmission and a phone call. Your vehicle uses data transmission to forward important information, such as the vehicle and position data, to an emergency call center.

Depending on the country and the vehicle equipment, the following functions may be available:

With the **emergency call**, you can call for help in dangerous situations as quickly as possible. Use this function when emergency help is needed ⇒ *page 209*.

– Audi connect emergency call (TPS emergency call). This eCall system uses third party emergency call centers, and if necessary, public emergency call centers.

With **online roadside assistance**, you can request assistance if there is a breakdown or a minor accident ⇒ *page 210*.

WARNING

In areas with poor GPS reception or outside the coverage range of the respective cell phone service provider, some functions and/or services may not be available, it may not be possible to send or receive data, or functionality may be limited.

Tips

To see which data can be transmitted, visit your Audi country or sales region website at www.audi.com.

Emergency call

Operation

Applies to: vehicles with emergency call function

The services are provided through a SIM card installed in the vehicle. Services are provided assuming that the mobile phone network required for the installed SIM card is functioning and available for use. The services made available by Audi are only available within the mobile phone net-

work coverage area for the mobile phone service provider selected by Audi.

Tips

- The emergency call function cannot be deactivated in the Infotainment system settings.
- The availability of the TPS emergency call is limited to certain times.
- The costs for call and data connections for TPS emergency calls is included in the price of the services.

Functions

Applies to: vehicles with emergency call function

A TPS emergency call can be made manually or automatically ⇒ *page 209*.

In the event that an automatic TPS emergency call is made, emergency responders as well as the local emergency call center or police station may receive the necessary information in order for help to arrive as quickly as possible.

Making an emergency call

Applies to: vehicles with emergency call function



Fig. 144 Front headliner: cover for the emergency call button

Manual emergency call

Requirement: the ignition must be switched on.

- ▶ Tap the cover **1** to open it.
- ▶ Press and hold the emergency call button until the LED **2** blinks. The emergency call will be made.
- ▶ If the emergency call button is pressed by mistake, then press it again immediately and hold ▶

it until the LED stays on. The emergency call will be canceled.

Automatic emergency call

The vehicle electrical system initiates an automatic emergency call under certain circumstances, for example if an airbag deploys. The LED in the emergency call button  will blink. The emergency call will be made. The emergency call cannot be canceled.

LED status

- **Green** – The emergency call function is available.
- **Red** – There is a malfunction in the emergency call function. Contact an authorized Audi dealer or authorized Audi Service Facility. Note the messages about the availability of the emergency function ⇨ *page 210*.
- **Off** – The emergency call function is not available, perhaps because no network is available.

Warnings

If there is a critical system failure in the emergency call systems, the vehicle occupants will receive the following warning: see ⇨ *page 210, LED status* and ⇨ *page 210, Messages*.

Tips

If the emergency call is canceled due to a poor connection, then the system automatically tries to connect again.

Sending the telephone number during an emergency call

Applies to: vehicles with TPS emergency call function

In case of an emergency call, your telephone number¹⁾ can be sent to a public emergency call center or police station to ensure help arrives as quickly as possible.

¹⁾ Compatibility cannot be guaranteed for all types of phones/SIM cards. Because of this, it may not always be possible to read out the phone number. The display will not indicate if there is a compatibility issue.

²⁾ The availability of the services offered depends on the country and may change in the future.

Turning on the function

Applies to: MMI

- ▶ Select on the home screen: **PHONE** > .
- ▶ Turn on the **Send telephone number during an emergency call** function.

Messages

Applies to: vehicles with emergency call function

Emergency call function: malfunction! Limited availability. Please contact Service

If this indicator light turns on and this message appears, the emergency call function is restricted. For example, you cannot call the emergency call center, but data may still be transmitted under certain circumstances. Drive to an authorized Audi dealer or authorized Audi Service Facility immediately to have the malfunction corrected.

Emergency call function: malfunction! Function unavailable. Please contact Service

If this indicator light turns on and this message appears, you cannot make an emergency call. Drive to an authorized Audi dealer or authorized Audi Service Facility immediately to have the malfunction corrected.

Online roadside assistance

Description

Applies to: vehicles with online roadside assistance

An online roadside assistance call²⁾ is a combination of data transmission and a phone call. The data transmission from your vehicle forwards important information to the Audi service center, such as the vehicle and position data.

Calling online roadside assistance

Applies to; vehicles with online roadside assistance



Fig. 145 Front headliner: online roadside assistance button

Calling online roadside assistance

- ▶ Press the button (3). The LED in the button turns red. The online roadside assistance call will be made.
- ▶ If you press the button (3) by mistake, then press it again.

Audi incident assistance

A minor accident may be detected by the vehicle electrical system. You are able to select between online roadside assistance and an emergency call in the MMI.

i Tips

If the roadside assistance call is canceled due to a poor connection, then the call must be made again.

Navigation

Opening navigation

Applies to: vehicles with navigation system



Fig. 146 Route guidance not started

The navigation system directs you to your destination, around traffic incidents, and on alternative routes, if desired.

Opening navigation

► Applies to: MMI: Press **NAVIGATION** on the home screen.

After accessing the navigation for the first time, the map is displayed.

Opening navigation using the multifunction steering wheel

- Select the Navigation tab in the instrument cluster.
- To display navigation when route guidance has started, select in the instrument cluster: the  button > **Map**.

The following functions are available in the MMI:

- ① Select destination ⇒ *page 214, fig. 147.*
- ② Intelligent search ⇒ *page 213.*
- ③ **Switch between the map and the menu:** press  repeatedly until the desired function is displayed.

You can find additional information about the map update at ⇒ *page 217, Map operation.*

WARNING

- The demands of traffic require full attention of all road users. Always read the chapter ⇒ *page 22, Traffic safety information.*
- The route calculated by the navigation system is a driving recommendation. Follow the traffic regulations that are applicable in

the country where you are operating the vehicle. In the event that the driving directions contradict traffic regulations, always follow the traffic regulations applicable in the country where you are operating the vehicle to reduce the risk of an accident.

Note

Read the information about Audi connect, and be sure to note the connectivity costs section ⇒  in *General information on page 203.*

Tips

- Snow and objects on the GPS antenna or trees and large buildings can impair satellite reception and affect the system's ability to determine the vehicle position. Several deactivated or malfunctioning satellites can interrupt GPS reception.
- Because street names sometimes change, the names stored in the MMI may in rare cases differ from the actual street name.
- Applies to: multifunction steering wheel: Depending on the selected function, operation through the MMI may be required.
- Applies to: vehicles with Audi connect Infotainment: Depending on the country and vehicle equipment, additional services may be available.
- An additional indicator will appear in the head-up display*.

myAudi navigation

Applies to: vehicles with myAudi navigation

MMI navigation works seamlessly with the myAudi app.

Your destinations (favorites, last destinations) are synchronized through your myAudi account. All important destinations can be displayed in the vehicle and in the myAudi app.

To load destinations in the vehicle automatically, Audi recommends logging into the vehicle with a myAudi user ⇒ *page 34.*

myAudi navigation functions:

- You can send destinations and routes from the myAudi app to the vehicle ⇒ *page 215*.
- Active route guidance in the myAudi app can be continued in the MMI.
- Depending on the situation, it may be possible to continue active route guidance from the MMI in the myAudi app to continue navigating to the destination after leaving the vehicle.

Tips

- All services/apps can be modified, activated/deactivated, renamed, and enhanced without further notification.
- Depending on the country and model there may be an app other than the “myAudi app” available for your vehicle. For additional information, see my.audi.com.

Entering a destination

Intelligent search for navigation destinations

Applies to: vehicles with navigation system

Using the intelligent search, you can enter the data for a navigation destination in any order all at once (for example, 5th Avenue New York). Likewise, you can search for points of interest, contacts, previous destinations, or favorites in order to navigate to the desired destination.



Opening a menu

- ▶ Applies to: MMI: Select on the home screen: **NAVIGATION** > .

Intelligent search





- ▶ Enter one or more search terms into the input field ⇒ *page 27, Text input*.
- ▶ Press on the desired destination in the results list. The **Details** menu will be displayed.
- ▶ Press **Start**. Route guidance will be activated and the map will be displayed ⇒ *page 216, fig. 149*.

Online Points of Interest

- ▶ **Searching for points of interest:** enter the name of a POI.
- ▶ Select: *a symbol for a POI category (such as ) > a POI, or*
- ▶ To display all categories and search for a POI, select:  > *a category (such as restaurants) > a POI.*

Change search area

Requirement: route guidance must be active.







- ▶ Applies to: MMI: Select on the home screen: **NAVIGATION** > .
- ▶ To change the search area, press  /  /  repeatedly until the desired search area is selected.

Online search¹⁾

Applies to: vehicles with navigation system and online search

You can use the results from a search engine provider to find a navigation destination.

Requirement: the MMI must be connected to the Internet ⇒ *page 203, Audi connect*.

- ▶ Applies to: MMI: Select on the home screen: **NAVIGATION** >  > .
- ▶ Enter one or more search terms into the input field.
- ▶ The search engine provider shows suggestions  to narrow down the search.
- ▶ Press on suggestions, if available, until the desired destination appears in the results list. If necessary, use one finger to swipe upward or downward until the suggestions  or destinations  appear.
- ▶ Press on the desired destination . The **Details** menu will be displayed.
- ▶ Press **Start**.

Tips

- The MMI input suggestions depend on the last navigated destinations. ▶

¹⁾ Audi provides access to services from third party providers. Permanent availability cannot be guaranteed, because that depends on the third party provider.

- The navigation system always searches for the fastest route. You can have alternative routes displayed if necessary ⇒ *page 219*.
- If the destination cannot be found, it may not be stored in the navigation database. Check the spelling of the term that was searched or check the search area ⇒ *page 213*.
- Distances to points of interest are displayed as a straight-line distance from your current location. The actual distance from your current location to the point of interest is updated automatically. The list of points of interest that were found is not resorted when this happens.

Select destination

Applies to: vehicles with navigation system



Fig. 147 Menu: select destination

Opening a menu

- Applies to: MMI: Press **NAVIGATION** on the home screen.
- If the map is displayed, press (1) ⇒ *page 212*, *fig. 146*.

The following functions are available:

① Last destinations	214
② Favorites	214
③ Contacts	214
④ Received destinations and routes .	215

Loading previous destinations

Applies to: vehicles with navigation system

Your last destinations and routes can be loaded as a navigation destination.

As soon as you start route guidance, the destination is automatically saved in the last destina-

tions. Your previous destinations are marked with the symbol.

If you use myAudi navigation, your previous destinations will be synchronized with your myAudi account ⇒ *page 212*.

Accessing previous destinations

- Applies to: MMI: Select on the home screen: **NAVIGATION** > > **Last destinations** > *select a destination* > **Start**.
- Select in the instrument cluster: Navigation tab > button > **Last destinations** > *a destination*.

Deleting previous destinations

- Applies to: MMI: Select on the home screen: **NAVIGATION** > > **Last destinations** > > *select one or more entries* or **Select all** > **Delete** > **(Done)**.

Tips

The last route will be automatically deleted from the list if you start a new route guidance after canceling the route.

Setting a favorite as the destination

Applies to: vehicles with navigation system

In the favorites, you can call up frequently-used destinations as well as your home/business address.

Requirement: a favorite must be stored ⇒ *page 219*.

- Applies to: MMI: Select on the home screen: **NAVIGATION** > > **Favorites** > *select a destination*.
- Select in the instrument cluster: Navigation tab > button > **Favorites** > *a destination*.

Selecting contacts as destinations

Applies to: vehicles with navigation system

You can navigate to contacts.

Requirement: a contact must have an address stored. ▶

- ▶ Applies to: MMI: Select on the home screen: **NAVIGATION** > (☰) > **Contacts** > *a contact*.
- ▶ Press on the address for a contact.
- ▶ Press on a suggested address. The **Details** menu will be displayed.

i Tips

- If a contact is grayed out, there is no address stored for that contact.
- Navigation to geographical coordinates for a contact is not possible.

Loading received destinations and routes

Applies to: vehicles with myAudi navigation

You can search for destinations or routes in the myAudi app and send to the vehicle.

Requirement: the MMI and the mobile device must be connected to the Internet ⇒ *page 203, Audi connect*. You must have the myAudi app installed on your mobile device.

- ▶ Send a destination or route in the myAudi app to the vehicle.
- ▶ Applies to: MMI: Select on the home screen: **NAVIGATION** > (☰) > **Received destinations and routes**.
- ▶ Make sure you are logged into the vehicle and the myAudi app with the same myAudi account. The received destination and routes will be loaded automatically.
- ▶ **Navigating to a destination:** press on a destination.
- ▶ **Deleting destinations:** select:  > *one or more entries* or **Select all** > **Delete** > **(Done)**.

i Tips

- All services/apps can be modified, activated/deactivated, renamed, and enhanced without further notification.
- Depending on the country and model there may be an app other than the “myAudi app” available for your vehicle. For additional information, see my.audi.com.

Destination details

Applies to: vehicles with navigation system



Fig. 148 Details

After you have selected a destination, the details will be displayed. Route guidance will not be active yet.

The functions depend on the vehicle equipment and the selected destination.

- ① **Map preview:** to zoom in on the map preview, press on the map.
- ② **Route criteria:** see ⇒ *page 223*.
- ③ **More:** additional functions.
- ④ **Weather:** Requirement: the MMI must be connected to the Internet ⇒ *page 203, Audi connect*. Also see ⇒ *page 205*.
- ⑤ **Call:** Requirement: a mobile device must be connected to the MMI ⇒ *page 190*. You will make a call to the phone number that is stored for the destination.
- ⑥ **Start:** starts navigation to the displayed destination. The map will be displayed ⇒ *page 217*.
- ⑦ **Parking:** press **Parking** to search for a parking space at the destination. You can use the parking space as a destination or stopover.
- ⑧ **Details:** Requirement: the MMI must be connected to the Internet ⇒ *page 203, Audi connect*.
- ⑨ **Display of distance/driving time to the destination**
- ⑩ **Weather at the destination:** Requirement: the MMI must be connected to the Internet ⇒ *page 203, Audi connect*.

Selecting a destination from the map

Applies to: vehicles with navigation system

A point on the map can be used as the destination.

Opening the map

- ▶ Applies to: MMI: Press **NAVIGATION** on the home screen.
- ▶ If necessary, press Δ to display the map.

Adjusting the scale

- ▶ Select: \oplus/\ominus > *select a scale*.

Marking the destination

- ▶ Press and hold a point on the map until a marking appears or the address for the selected destination is shown.

Selecting map content (such as POIs) as the destination

Requirement: map content must be displayed
⇒ *page 222*.

- ▶ Press on map content on the map (for example, H).

Selecting the destination

- ▶ Select: H > **Start**.

Stopovers and route plan

Applies to: vehicles with navigation system

You can enter additional destinations during active route guidance.

Entering a stopover

Requirement: route guidance must be active.

- ▶ Enter a destination ⇒ *page 213*.

Displaying stopovers or the route plan

All destinations are listed in the route plan.

- ▶ Press on H in the side menu on the map ⇒ *page 216, fig. 149*.

Editing stopovers

- ▶ Press on H in the side menu on the map ⇒ *page 216, fig. 149*.

- ▶ **Adding a stopover:** Select: **Add destination** > *select a destination* > **Add to route**.
- ▶ **Moving a stopover:** press H . Touch the \blacklozenge symbol and move the entry to the desired position. Press **Done**.
- ▶ **Deleting a stopover:** Select: H > *one or more entries* or **Select all** > **Delete** > **(Done)**.

Stopping route guidance

Applies to: vehicles with navigation system

Requirement: route guidance must be active and the map must be displayed.

- ▶ Applies to: MMI: Press H ⇒ *page 216, fig. 149*.
- ▶ Select in the instrument cluster: Navigation tab > H button > **Cancel route guidance**.

Map

Map functions

Applies to: vehicles with navigation system



Fig. 149 Active route guidance





Fig. 150 Marked map object

Opening the map

- ▶ Applies to: MMI: Press **NAVIGATION** on the home screen.
- ▶ If necessary, press Δ to display the map.





The following list gives an overview of the information displayed on the map. Press on any function (for example, alternative routes) to show additional options.

- ① Select destination ⇒ *page 214*

- ② Entering a destination ⇒ *page 213*
- ③ Cancel route guidance ⇒ *page 216*
- ④ Current route
- ⑤ Request spoken prompt
- ⑥ Alternative routes ⇒ *page 219*
- ⑦ Display active destinations, stopovers, or route plan ⇒ *page 216*. The distance to the destination including the calculated arrival time is displayed
- ⑧ Online traffic information ⇒ *page 221*
- ⑨ Altitude
- ⑩ Displays the maximum permitted speed¹⁾: within city limits, on expressways, and on highways
- ⑪ Current vehicle position
- ⑫ Route information ⇒ *page 223*
- ⑬ Name of the street on which you are driving
- ⑭ Start route guidance for a marked destination ⇒ *page 216, Selecting a destination from the map*
- ⑮ Display details for the destination ⇒ *page 215*
- ⑯ Intelligent search nearby ⇒ *page 213*
- ⑰ Adjust the map orientation. See also ⇒ *page 222*
- ⑱ Settings ⇒ *page 222*
- ⑲ Adjust the scale. Press the magnifying glass to switch automatic zoom ⇒ *page 222* on the map on or off. The  symbol appears when this function is switched on
- ⑳ Marked destination ⇒ *page 216, Selecting a destination from the map*
- ㉑ Map contents (points of interest, favorites). When there are multiple map contents in the immediate vicinity, the symbols are shown stacked on the map. To display a list of individual symbols, press  ⇒ *fig. 150*. Press on a POI in the list
- ㉒ Center the map to the current vehicle position
- ㉓ Traffic incidents and display of estimated losses of time on the route

- **Green:** traffic is flowing freely.
- **Orange:** stop-and-go traffic
- **Red:** traffic jam or traffic obstructions.

Additional possible symbols on the map

Symbol	Description
	Home address ⇒ <i>page 219, Favorites</i>
	Business address ⇒ <i>page 219, Favorites</i>
	Favorites ⇒ <i>page 219</i>
	Previous destinations display

Traffic information

- **Colored warning symbols:** traffic incidents ahead that are on your route.
- **Grayed out warning symbols:** traffic incidents that are not on your route.
- All traffic incidents will display in color when route guidance is inactive.
- **Warning symbols with arrow:** traffic incident that you have been routed around, for example .

Map operation

Applies to: vehicles with navigation system

You can operate the map ⇒ *page 216, fig. 149* with the movements described in the following information.

Moving the map

- ▶ Drag your finger across the map in the desired direction.

Moving the map quickly

- ▶ Swipe your finger across the map in the desired direction and lift your finger off the map.

Zooming in on the map

- ▶ Place two fingers on the map and pull your fingers apart, or
- ▶ Double-tap on the map with one finger. ▶

¹⁾ Applies to vehicles without camera-based traffic sign recognition.

Zooming out on the map

- ▶ Place two fingers on the map and pull your fingers together, or
- ▶ Double-tap on the map with two fingers.

Rotating the map

- ▶ Rotate the map using two fingers.

Tilting the map

- ▶ Drag upward or downward with two fingers.

i Tips

Certain gestures may not be available on all touch displays or in every menu.

Navigation view with route guidance started

Applies to: vehicles with navigation system and Audi virtual cockpit

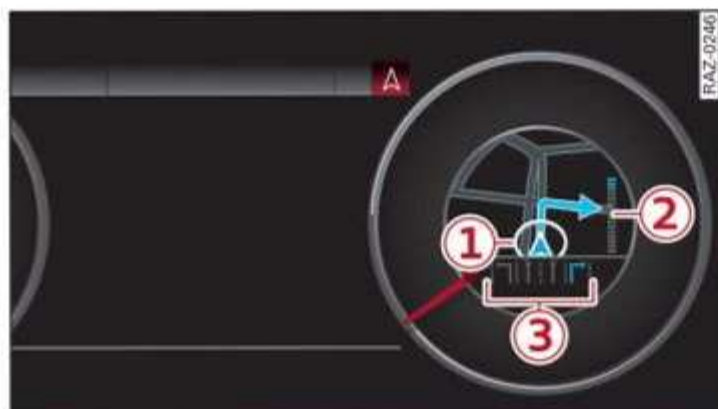

Fig. 151 Instrument cluster: default view: turning maneuver when route guidance has started

Requirement: route guidance must be on
⇒ page 213.

The following information will be displayed in the driver information system, if available:

- ① Current vehicle position
- ② A bar graph appears when there is an upcoming turn. The fewer the bars that are shown, the shorter the distance is until the turn. If there is no upcoming turn immediately ahead, the distance to the destination or stopover, the calculated arrival time, and a direction arrow for the upcoming maneuver will be displayed in the right speedometer. If there is no upcoming maneuver, the distance to the next maneuver will be displayed.
- ③ Lane recommendation

Predictive route guidance

Applies to: vehicles with navigation system and predictive route guidance

Your MMI can learn the routes that you drive frequently (such as your daily commute to work and back) and suggest route guidance based on the current vehicle position.

When the function is switched on, the MMI records the routes driven regardless of whether or not you are using navigation.

Without starting route guidance, your MMI can check the traffic conditions and show possible traffic incidents for the possible routes to be driven.

Opening personal routes

Requirement: predictive route guidance is switched on ⇒ page 223. Route guidance must not be active. A notification is displayed.

- ▶ The MMI displays up to three suggestions. Press on a suggestion. Route guidance will start.

Better routes

If there are major traffic incidents, the MMI will display a notification regardless of the selected menu. If the MMI has calculated a better route, you can select it as the route.

- ▶ Press on the notification.

As soon as you switch off predictive route guidance, your personal routes will no longer be recorded. Routes that were already stored will remain stored.

Deleting personal routes

- ▶ Applies to: MMI: Select on the home screen: **NAVIGATION** > **Settings** > **Predictive route guidance** > **Delete recordings from the last 24 hours** or **Delete all personal routes and destinations**.

i Tips

If the predictive route guidance is switched off and you press **NAV**, the predictive route guidance settings will be displayed ⇒ page 223.

Alternative routes

Applies to: vehicles with navigation system



Fig. 152 Alternative routes in the overview map

Opening alternative routes

Requirement: route guidance must be started
 ⇨ page 213 and the map must be displayed
 ⇨ page 217.

- ▶ Press on in the side menu on the map
 ⇨ page 216, fig. 149.

① Current route

The distance to the destination and the calculated arrival time will be displayed for the current route.

② Alternative route

The difference in travel time compared to the selected route will be displayed.

③ Block route

You can block the current route for a certain distance starting from the vehicle position, for example to drive around upcoming streets or tunnel closures. The navigation system automatically calculates an alternative route and the length of the blocked route. The route to be avoided that you have entered applies only to the current route and must be set again, if needed. The areas you have selected to avoid will appear with red and white shading on the map.

- ▶ **Block route:** press ⇨ fig. 152.
- ▶ **Cancel route block:** press .

Displaying alternative routes in the foreground

- ▶ Press in the corresponding information window, or

- ▶ Press and hold the information window for the corresponding alternative route (for example, ⇨ fig. 152).

Select route

- ▶ Press on the information window for the corresponding route (for example).

Additional functions

Favorites

Applies to: vehicles with navigation system

In the favorites, you can call up frequently-used destinations as well as your home/business address.

Accessing favorites

- ▶ Applies to: MMI: Select on the home screen:
NAVIGATION > > **Favorites**.

If you use myAudi navigation, your favorites will be synchronized with your myAudi account
 ⇨ page 212.

Storing favorites

- ▶ Press in the **Details** menu ⇨ page 215, fig. 148.

Storing a home address or business address

- ▶ Press **Home address** or **Business address**.
 When accessed for the first time, you will be prompted to set the address.
- ▶ Select: **Create now** > *enter a destination* > **OK**.

Editing a home address or business address

Requirement: the favorites list must be displayed. Your home address or business address must be stored.

- ▶ Press **Home address** or **Business address** until the **Options** menu is displayed.
- ▶ Select: **Change address** > *enter a destination* > **(Set as destination)** or **(Add to address)** > **OK**.

Editing favorites

Requirement: the favorites list must be displayed.

- ▶ **Setting a favorite as a destination:** press on a favorite. ▶

- ▶ **Deleting favorites:** in the **Details** menu, press **★** ⇒ *page 215, fig. 148*, or select: **✎** > *one or more entries* or **Select all** > **Delete** > **(Done)**.
- ▶ **Moving a favorite:** press **✎**. Touch the **◆** symbol and move the entry to the desired position. Press **Done**.

i Tips

- After deleting the home address or business address, only the address is deleted and the entry will still be displayed in the favorites.
- Please note when moving favorites that items 1 and 2 are reserved for the home address and business address.

On-street parking

Applies to: vehicles with navigation system and on-street parking

In supported areas, you can display parking along the route.

Requirement: the **Parking** notification must be switched on ⇒ *page 25, Notification center*. The MMI must be connected to the Internet ⇒ *page 203, Audi connect*. Route guidance must be active, you must be close to your destination, and a notification must be displayed or an item on the map must be marked.

- ▶ Press on the notification, or
- ▶ Press **☐** on the map.
- ▶ To navigate to a parking: space, press on a colored marking on the map.
- ▶ Select: **☐** > **Start**.

Depending on availability, colored markings on the map indicate the probability of open parking spaces.

Color	Description
Green	High probability
Orange	Medium probability
Red	Low probability

Satellite map

Applies to: vehicles with navigation system and satellite map

You can display the navigation map with satellite images.

Requirement: the MMI must be connected to the Internet ⇒ *page 203, Audi connect*.

- ▶ Applies to: MMI: Select on the home screen: **NAVIGATION** > **⚙** > **Map settings** > **Satellite map**¹⁾.

The map view is based on data packets received from the Internet in the form of satellite images, which are then combined with the roadways from the ⇒ *page 216, fig. 149* standard map view.

i Tips

- The satellite map¹⁾ is updated regularly whenever the function is opened. The process may take several seconds.
- Depending on the Internet connection, the standard map may also be displayed when the satellite map is switched on¹⁾.

Map update

Introduction

Applies to: vehicles with navigation system

You can update the map data in the MMI with a map update. The functions depend on the country and vehicle equipment.

- Map update through **online map update** ⇒ *page 220*.
- Import a map update from the **USB connection** to your MMI ⇒ *page 221*.

Online map update

Applies to: vehicles with online map update

Using the online map update, you can update the map content for your navigation system in your vehicle. ▶

¹⁾ Audi provides access to services from third party providers. Permanent availability cannot be guaranteed, because that depends on the third party provider.

The MMI determines regions based on the vehicle position. Based on this, update data for these regions are available for your MMI.

Starting the update

Requirement: the MMI must be connected to the Internet ⇒ *page 203, Audi connect.*

- ▶ Applies to: MMI: To allow automatic map updates, select on the home screen: **SETTINGS** > **System maintenance** > **Automatic online map update**. The MMI starts the map update automatically in the background when new map material is available.

You can check the status of the download process and the installation in the notification center ⇒ *page 25.*

Note

Read the information about Audi connect, and be sure to note the connectivity costs section ⇒ *!* in *General information on page 203.*

Tips

Because of the high volume of data, Audi recommends performing the map update using the USB connection ⇒ *page 221.*

Map update using the USB connection

Applies to: vehicle with map updates using the USB connection

With the map update, you can update the map material in your navigation system.

Requirement: you must have created a myAudi account at my.audi.com. Your vehicle must be registered in your myAudi account.

Downloading updates

- ▶ Download the map update at my.audi.com and store it on a USB flash drive. For additional information, visit my.audi.com.

Installing updates

- ▶ Connect the USB flash drive to the USB port with charging function ⇒ *page 234.*
- ▶ Open the notification in the notification center on ⇒ *page 25* and press on the notification.

- ▶ Press **Next**. The status of the installation is shown in the display.

Traffic incidents

Introduction

Applies to: vehicles with navigation system and online traffic information



Fig. 153 Traffic information overview

Open traffic information

Requirement: the map must be displayed ⇒ *page 217.*

- ▶ Press on the traffic jam symbol in the side menu on the map ⇒ *page 216, fig. 149.*

Display traffic report details

- ▶ Press on the traffic report ②.
- ▶ To display the previous or next traffic report, press ← or →.

The following information can be displayed:

- ① A message will appear if the MMI calculates a better route for the current route guidance. The predicted delay takes into account future changes to the traffic situation on the route. Press on an item in a list ① and select the better route. More information can be found under ⇒ *page 219.*
- ② A traffic message is displayed. The distance to the hazardous area is calculated from the current vehicle position.
- ③ The traffic messages are only shown when route guidance is active. Press on a line to display details about it.

Tips

– Particularly critical traffic information, such as warnings about wrong-way drivers, is automatically displayed as a notification.

– Traffic information is not available in some countries.

Traffic rerouting

Applies to: vehicles with navigation system

By receiving traffic information, your MMI calculates a better route if available and the possible time saved compared to the current route.

Traffic rerouting

- ▶ Start route guidance.

The MMI uses a notification or a note in the traffic information ① ⇒ *page 221, fig. 153* to indicate a better route. You can decide which route you would like to use.

To select a better route, you have the following options:

- ▶ **Notification:** press . The better route will be used for route guidance, or press on the notification. Press on the information window for the better route (for example ② ⇒ *page 219, fig. 152*).
- ▶ **Note in the traffic information:** press on the list entry ① ⇒ *page 221, fig. 153*. Press on the information window for the better route (for example ② ⇒ *page 219, fig. 152*).

Online traffic information

Applies to: vehicles with navigation system and online traffic information

The MMI can receive real-time online traffic information about congestion, accidents, road construction, and other incidents.

Requirement: the MMI must be connected to the Internet ⇒ *page 203, Audi connect*. Traffic information must be switched on in the MMI ⇒ *page 222*.

Traffic information will be displayed on the standard map ⇒ *page 216, fig. 149*.

Depending on vehicle equipment, online traffic information may also be displayed on the satellite map ⇒ *page 220*.

Tips

- Having the **online traffic information** function switched on provides the most accurate reports of traffic situations and traffic forecasting. Your vehicle transmits and processes its anonymous, encrypted position information at regular intervals to the traffic data provider. You can switch off data transfer at any time ⇒ *page 316*.
- The **online traffic information** network is not available in all countries, and the coverage is not nationwide.

Settings

Applies to: vehicles with navigation system

You can adjust the navigation system settings in the instrument cluster and in the MMI display separately. The settings depend on the country and vehicle equipment.

Accessing settings

- ▶ Applies to: MMI: Select on the home screen: **NAVIGATION** > .

Accessing settings using the multifunction steering wheel

- ▶ Select in the instrument cluster: Navigation tab >  button.

A setting made using the multifunction steering wheel only applies to the instrument cluster map.

Map settings

Satellite map: see ⇒ *page 220*.

Traffic info: you can display current traffic information on the map.

- **Free flowing traffic**
- **Traffic obstructions**
- **Traffic incidents**

Map colors

- **Automatic:** the map display adapts to the lighting conditions (for example, by changing from day to night when driving through a tunnel).
- **Day or Night** ▶

Map orientation

- **2D heading-up map/2D north-up map:** the current vehicle position is displayed. The map is oriented in the direction of travel or to the north.
- **3D map:** the current vehicle position is shown on a three-dimensional map and is aligned in the direction of travel.
- **Overview:** the entire route from the vehicle position to the destination or the next stopover is displayed on the map. The map is oriented to the north.

Automatic zoom

- **On:** the map scale is adapted automatically depending on the type of road being traveled (expressway, highway, other roads) so that you always have an optimal overview of the road ahead. When route guidance is active, the scale is adjusted automatically for a better detailed view when there are upcoming maneuvers.
- **Intersection:** when route guidance is active, the scale is adjusted automatically for a better detailed view when there are upcoming maneuvers.
- **Off**

MMI map contents/Map content: you can switch the display of additional information (such as POIs) on the map in the upper display on or off.

Voice guidance

Voice guidance: with the **Traffic info** setting, the MMI will only give prompts if there are traffic incidents on your route.

Voice guidance during phone call

Entertainment fader during navigation: the audio playback volume is temporarily lowered when navigation prompts are active.

Route criteria

You can adjust which route criteria should be allowed or avoided for the route calculation.

HOV/carpool lanes

Highways

Toll roads

Ferries

Route information

When this function is switched on and route guidance is active, route information ⇒ *page 216, fig. 149* is displayed. The next maneuver will be displayed at the bottom. POIs and traffic information will also be displayed. Press route information to display a preview of the next maneuver on the map. You can switch the following information on or off in route information.

– POIs along the route

– Traffic information along the route

Predictive route guidance

The predictive route guidance is switched off when the vehicle is delivered from the factory.

Your trips are recorded and destinations are suggested by the MMI when this function is switched on ⇒ *page 218*.

Presentation mode

In presentation mode, the system simulates driving on the display along the planned route without the vehicle actually moving. You can use **Specify starting point** when you would like to calculate a route starting from a location other than the current vehicle position, for example.

Simulating route guidance: start route guidance and press presentation mode.

Tips

You can change the volume of navigation announcements while one is playing ⇒ *page 33*.

Radio

General information

Selecting the radio



Fig. 154 Upper display: FM station list



Fig. 155 Upper display: SiriusXM channel list

Depending on the vehicle equipment, the radio may support the FM, AM, and SiriusXM (satellite radio) frequency bands. Using the HD Radio receiver* also allows you to receive radio stations on the FM and AM bands in digital format.

Depending on the vehicle equipment and the selected station list, the following information will be displayed:

① Station list

Shows the stations that are currently available. The station list updates automatically.

② Stations

For example, the station name may be displayed depending on availability.

③ HD Radio technology

FM/AM stations that can be received by digital radio are marked with the HD Radio technology symbol **HD**.

If reception quality declines, the radio automatically switches to the analog FM/AM station depending on availability.

④ Additional audio programs

Digital HD Radio stations may contain multiple additional audio programs. If you lose reception, the additional audio programs will

be muted since they can no longer be received.

⑤ Radio ID

Your radio ID and contact data for your satellite radio provider are displayed.

⑥ Channel number

⑦ No reception

The station cannot be received.

In addition to the symbols for the usual frequency bands, the following information may also be available depending on vehicle equipment:

Symbol	Description
	The station provides information in the background for an online station alternative. Online station tracking must be switched on for this → page 230 .
	The station is received through the Internet.
	The system attempts to receive the station/podcast through the Internet.

i Tips

- Contact the SiriusXM* provider if you would like to receive satellite programming.
- Buildings, tunnels, bridges, open areas, other vehicles or objects on the vehicle roof can affect reception.
- Satellite radio* is not available in all regions.

Adjusting the radio using the MMI

- ▶ Applies to: MMI: To set a frequency band, select on the home screen: **RADIO** > **Source** > *a category*.
- ▶ Applies to: MMI: To set a station, select on the home screen: **RADIO** > **Source** > *a category* > *a station/podcast**.
- ▶ To select a frequency, follow the instructions under → [page 226](#), *Free text search*.

Adjusting the radio using the multifunction steering wheel

Requirement: radio mode must be on. ▶

- ▶ Select the radio/media tab in the instrument cluster.
- ▶ Press the  button to toggle between the radio and media or to select a different source.
- ▶ To select a station or a source, turn and press the left thumbwheel.

Tips

Applies to: multifunction steering wheel: Depending on the selected function, operation through the MMI may be required.

Adjusting the radio using the Rear Seat Remote

Applies to: vehicles with Rear Seat Remote

- ▶ Applies to: Rear Seat Remote: Press **RADIO** on the home screen.

Operation of the available radio functions using the Rear Seat Remote is very similar to operation in the MMI ⇨ *page 225*.

Radio functions

Overview















Fig. 156 Upper display: left side: playback view of radio functions, right side: sources

Operating

- ▶ Applies to: MMI: To open the playback view (1), select on the home screen: **RADIO** > **Source** > *a category* > *a station/podcast**.
- ▶ Applies to: MMI: To open the sources (2), select on the home screen: **RADIO** > **Source**.

The following functions may be available depending on the selected radio station/podcast* and the vehicle equipment:

	Symbol/Description	Description
(3)		Displaying categories in a frequency band.
(4)	Source	Displays sources in the Radio menu.
(5)	Frequency band	Shows the current station frequency band.
(6)	ON	Indicates that on demand content is playing. The MMI must be connected to the Internet for this.
(7)		Presets ⇨ <i>page 227</i>
(8)		Settings ⇨ <i>page 230</i> .

	Symbol/Description	Description
9	Station logo	Depending on availability, you can switch between the image views: press on the station logo. Use one finger to swipe to the right or left to switch between the Station logo and Cover art (album cover). Also see ⇨ <i>page 230</i> , Online additional data .
10		Go back one level.
11	Search	See ⇨ <i>page 226</i> .
12	Last stations	See ⇨ <i>page 227</i> .
13	Presets	See ⇨ <i>page 227</i> .
14	FM	Displays stations from the FM frequency band.
15	Online	See ⇨ <i>page 228</i> .
16	SiriusXM	Displays stations from the SiriusXM frequency band. Combines SiriusXM Live channels and on demand content, depending on vehicle equipment.
17	AM	Displays stations from the AM frequency band.
18	Start over	Go to the beginning of the broadcast.
	Related	Channels, artists, and shows related to the content that is currently playing.
	Subscribe	Log in to be able to play the content.
	Switch to WEB	Switch manually to Internet reception.
	Switch to SAT	Switch manually to satellite reception.
19	More	Access options for the current station ⇨ <i>page 229</i> .
20		Selecting the previous or next track: press  or  . Going to the beginning of the recording: press and hold  . Going to the live program: press and hold  . The LIVE symbol will be displayed.
21	 / 	Select the previous/next station.
22		Start or stop playback
		Unmutes or mutes playback.
23	List	The station list is displayed ⇨ <i>page 224</i> .
24	Info section	Depending on availability, the station name as well as program information, for example, may be displayed. Also see ⇨ <i>page 230</i> , Online additional data .

Note

Read the information about Audi connect, and be sure to note the connectivity costs section ⇨  in *General information on page 203*.

Tips

Not all functions are available in every source and on every touch display.

Free text search

Using intelligent search, you can search for station names, frequencies, program types (such as **News**), podcasts*, or online radio stations*.





Opening free text search

- ▶ Applies to: MMI: Select on the home screen: **RADIO > Source > Search**.

Entering search terms

You can enter multiple search terms at once in any order.

The following information may be available:

Symbol	Description
	Results from the list: Last stations
	Results from the list: Presets
	Results from a Station list
For example, 	Station frequency band

Last stations

You can listen to the last stations that were played in all frequency bands.

Accessing last stations

- Applies to: MMI: Select on the home screen: **RADIO > Source > Last stations**.

Listening to last stations

- Press on *a station*.

Deleting last stations

- Select:  > *select one or more stations* or **Select all > Delete > (Done)**.

Presets

You can store your favorite stations from every frequency band in the presets list.

Applies to: SiriusXM: Channels, shows, and sports teams will be stored in the presets as Smart Favorites. After switching the ignition and the MMI on, the Smart Favorites store radio programs at a specific time.

Selecting presets using the MMI

- Applies to: MMI: Select on the home screen: **RADIO > Source > Presets > a preset**.

Storing presets

- Press on   in the playback view ⇒ *page 225, fig. 156*.



Requirement: a list with radio stations must be displayed ⇒ *page 224, fig. 154*.

- Press and hold an entry in the list until the **Options** menu appears.
- Press **Store as preset**.

Editing presets

- **Deleting presets:** press  in the playback view, or
- In the presets list, select:  > *one or more stations* or **Select all > Delete > (Done)**.

Requirement: the presets list must be displayed.

- **Moving a preset:** press .
- Touch the  symbol and move the entry to the desired position.
- Press **Done**.

Live Sports

Applies to: vehicles with SiriusXM

Using the Live Sports category, you can find live commentary about your favorite teams during a live sports broadcast. Depending on vehicle equipment, you may be able to switch commentary that favors a certain side on or off.

Accessing live games

- Applies to: MMI: Select on the home screen: **RADIO > Source > SiriusXM >  > Sports > Live Sports > a game**.



The score, the status of the game, and, if available, the current possession of the ball are displayed.

Saving/deleting a favorite team

- Press .

Switching commentary on or off

Requirement: the MMI must be connected to the Internet.

- Press / .

Radio text

Program information (for example, general text messages, artist, composer, song) is displayed in the radio text. ►

Requirement: the selected radio station must support the radio text function.

Opening radio text

- ▶ Applies to: MMI: Select on the home screen: **RADIO** > *select a frequency band (such as FM)* > *select a station* > **More** > **Radio text**.

Depending on vehicle equipment, the following functions may be available:

Displaying previous radio text entries

- ▶ Swipe downward with one finger. The last radio text entries are displayed if they are available.

Scrolling through radio text entries

- ▶ Swipe upward or downward with one finger.

Showing Radio Text Plus information

If a radio text entry is displayed with a color, a phone number or a navigation destination for the station is available as radio text plus information.

You have the following options:

Selecting the destination

- ▶ Select: *a navigation destination marked in color* > **Set as destination**.

Call

- ▶ Select: *a phone number marked in color* > **Call**.

Tips

A call to a phone number stored in the radio text will start immediately.

Online radio

General information

Applies to: vehicles with Audi connect Infotainment and online radio

You can listen to various radio stations or podcasts on the Internet using online radio.

Requirement: the MMI must be connected to the Internet ⇒ *page 203, Audi connect*. Depending on the country, a data package may also be required ⇒ *page 208*.

Accessing online radio through the MMI

- ▶ Applies to: MMI: Select on the home screen: **RADIO** > **Source** > **Online**.

The following functions are available:

Previous selection

The station/podcast list for the last station or podcast that was playing will be displayed.

Top stations

The favorite online radio stations are displayed.

Filter list

- ▶ Select:  > *(a category)* > *a station/podcast*.

Note

Read the information about Audi connect, and be sure to note the connectivity costs section ⇒  in *General information on page 203*.

Tips

- Depending on the Internet connection and network traffic, the connection may be lost when online radio is playing.
- Online radio reception may not be possible if Internet service is throttled.
- Online media usage depends on the service availability of the third party provider.
- The range and screen display of online media services from third party providers in the vehicle can vary.
- Please note that it may not be possible to play some online radio stations in certain countries.
- Audi only provides access to online radio and does not assume any responsibility for the content of these services.

Podcasts

Applies to: vehicles with Audi connect Infotainment and online radio

Opening podcasts using the MMI

- ▶ Applies to: MMI: Select on the home screen: **RADIO** > **Source** > **Online** > **Podcasts**.

The following functions are available: ▶

Listening to a podcast

- ▶ Select: *a podcast > a podcast episode.*

Search

- ▶ Press .

The following functions are available in the podcast playback view:

Displaying podcast episodes

- ▶ Press **List**.

Starting/stopping podcast playback

- ▶ Press  / **II**.

Previous/next podcast

- ▶ Press **K** / **D**.

Changing the playback position

- ▶ Move the slider into the desired position.

Displaying the online radio menu

- ▶ Press .

Switching to radio

- ▶ Press **Source**. The sources in the Radio menu are displayed.

Podcast favorites

You can store podcasts in the podcast favorites.

Requirement: the playback view for a podcast must be displayed.

- ▶ Press  **(7)** ⇨ *page 225, fig. 156.*

Requirement: a list with podcasts must be displayed.

- ▶ Press and hold an entry in the list until the **Options** menu appears.
- ▶ Press **Save podcast**.

Listening to podcast favorites

Requirement: the podcast favorites list must be displayed. At least one podcast favorite must be stored.

- ▶ Select: *a podcast > a podcast episode.*

Browsing through podcast favorites

Requirement: the podcast favorites list must be displayed. At least one podcast favorite must be stored.

- ▶ Press **<** or **>**.

Displaying all podcast favorites



Requirement: the podcast favorites list must be displayed. At least one podcast favorite must be stored.

- ▶ Press **All**.

Editing podcast favorites

- ▶ **Deleting podcast favorites:** press  in the playback view, or
- ▶ In the podcast favorites list, select: **All** >  > *one or more podcasts*, or **Select All** > **Delete** > **(Done)**.

Requirement: the podcast favorites list must be displayed.

- ▶ **Moving podcast favorites:** Select: **All** > .
- ▶ Touch the  symbol and move the entry to the desired position.
- ▶ Press **Done**.

Options and settings

Options

Requirement: the playback view **(1)** ⇨ *page 225, fig. 156* must be displayed.

- ▶ Press **More** **(19)**, or

Requirement: a list with radio stations or podcasts* must be displayed ⇨ *page 224, fig. 154.*

- ▶ Press and hold an entry in the list until the **Options** menu appears.

Depending on the selected source and vehicle equipment, the following functions may be available.

- **Store as favorite** ⇨ *page 227.*
- **Radio text** ⇨ *page 227.*
- **Save podcast** ⇨ *page 229, Podcast favorites.*
- **Save as a shortcut** ⇨ *page 26, Shortcuts.* ▶

Related content

Channels, artists, and shows related to the content that is currently playing.

Settings

► Applies to: MMI: Select on the home screen: **RADIO** > .

Depending on the vehicle equipment, the following settings may be available:

HD Radio FM/HD Radio AM

You can switch HD Radio reception on or off.

SiriusXM Tune Start

If you play a Smart Favorite or Internet radio station when this function is switched on, the song currently playing on the channel will play from the beginning.

SiriusXM subscription status

The status of your license is displayed.

Call SiriusXM: the telephone number and radio ID of your satellite radio provider are displayed. To call your satellite radio provider using the MMI, press **Call SiriusXM**.

Online additional data

Requirement: the MMI must be connected to the Internet ⇒ *page 203, Audi connect*. Depending on the country, a data package may also be required ⇒ *page 208*.

When the function is switched on, additional information (such as album cover, artist, track) will be loaded depending on the availability.



Online station tracking

Requirement: the MMI must be connected to the Internet ⇒ *page 203, Audi connect*. Depending

Troubleshooting

The information that follows lists some troubleshooting options. They depend on the equipment. ►

on the country, a data package may also be required ⇒ *page 208*. A station provides information in the background for its online station alternative and is identified with the  symbol.

During reception loss in the FM frequency band, the radio tuner can establish a data connection and switch to an online station alternative, if it is available. If available, you can receive your local radio stations in every region of your country online. This may result in additional costs ⇒ . The  symbol indicates a station that is currently being received online.

- **Automatic/Off:** activates or deactivates automatic switching to online station alternatives.
- **With request:** switching to online station alternatives must be confirmed manually.

Preferred online radio data rate

Depending on the selected radio station, you may be able to adjust the data rate for Internet radio ⇒ *page 228* and for the **Online station tracking**.

For optimal sound playback, press **High**. To reduce data usage, press **Low**.

Note

Read the information about Audi connect, and be sure to note the connectivity costs section ⇒  in *General information on page 203*.

Tips

Delays may occur when switching automatically between normal frequency bands and online radio.

Problem	Solution
A station is no longer displayed in the station list.	Store the station as a preset in advance. Access the presets using the presets list ⇒ <i>page 227</i> .
Online radio: no playback from online radio.	Check if a data plan has been purchased for the applicable country and it is available ⇒ <i>page 208</i> .

Media

General information

There may be different media sources and connections available depending on the vehicle equipment. For example, you can play media files using a connected USB drive or connect your mobile devices to the USB ports with charging function and operate them through the MMI.

Media and format restrictions: the MMI (including the USB storage device connection) was tested with a variety of products and media on the market. However, there may be cases where individual devices/media and media files may not be recognized, may play only with restrictions, or may not play at all.

Restricted functionality: reset the MMI to the factory default settings if functionality is restricted ⇒ *page 247*.

Digital Rights Management: please note that the media files are subject to copyright protection.

Files that are protected by DRM and are identified with the symbol  will not play.

Data security: never store important information on mobile devices. Audi is not responsible for damaged or lost files and media.

Loading times: the more files/folders/playlists there are on a storage medium, the longer it will take to load. To reduce the amount of time it takes the media files to load, use a storage medium that only contains media files, and create subfolders (for example, for each artist or album).

Additional information: when playing, audio files are automatically displayed with any additional information that is stored (such as the artist, track and album cover). If this information is not available on the medium, the MMI will revert to the local Gracenote metadata database or search online if necessary. See ⇒ *page 238*, **Online additional data**. However, in some cases, the additional information may not be displayed.

Note

Read the information about Audi connect, and be sure to note the connectivity costs section ⇒  *in General information on page 203*.

Bluetooth audio player

Applies to: vehicles with Bluetooth audio player

With the Bluetooth audio player, you can play music wirelessly through the MMI from your Bluetooth-capable mobile device (such as a cell phone).

Requirement: the vehicle must be stationary and the ignition must be switched on. The Bluetooth settings will open on your mobile device during the connection setup. The Bluetooth function and visibility of the MMI ⇒ *page 247* and mobile device must be switched on.

Connecting a mobile device

- ▶ Applies to: MMI: Select on the home screen: **MEDIA > Source > Connect external device > New connection**. The available Bluetooth devices will be displayed after several seconds.
- ▶ Press on the desired mobile device in the list of displayed Bluetooth devices.
- ▶ To update the list, press .

A PIN for a secure Bluetooth connection will be generated.

- ▶ Confirm the PIN on your mobile device.

After connecting successfully, the mobile device will be displayed in the **Connected devices** menu as a Bluetooth audio player.

Playing media ⇒ *page 235*.

Tips

- Check for any connection requests on your Bluetooth device.
- Multiple Bluetooth audio players can be paired with the MMI, but only one at a time can be active as a Bluetooth audio player ⇒ *page 247*.
- The supported media functions (such as shuffle, list view, categories, search, options) depend on the Bluetooth device being used.

- Note the volume setting on your Bluetooth device. Audi recommends setting your mobile device to the maximum volume when using it as a Bluetooth audio player.
- A selection of supported Bluetooth devices can be found in the database for tested mobile devices at www.audi.com/bluetooth.

Online media

Applies to: vehicles with Audi connect Infotainment and online media

You can play and operate various online media services, such as music streaming services, using the MMI.

Requirement: a supported online media service must be available in the country where the vehicle is being operated. you must be logged in to your myAudi account in the vehicle. The MMI must be connected to the Internet ⇒ *page 203, Audi connect*. Depending on the country, a data package may also be required ⇒ *page 208*.

Connect online media

- ▶ Applies to: MMI: Select on the home screen: **MEDIA > Source > Streaming services**. All supported online services in your country will be displayed for the user that is logged in.
- ▶ Press on the desired online media service and follow the system instructions.

After successfully logging in, the online media service will be available as a media source.

Starting online media

- ▶ Applies to: MMI: Select on the home screen: **MEDIA > Source > an online media source**.

WARNING

Always follow the information found in ⇒  in *General information on page 203*.

Note

- Read the information about Audi connect, and be sure to note the connectivity costs section ⇒  in *General information on page 203*.

- There generally are additional costs when using an online media service account, especially when it is used internationally.

Tips

Depending on the Internet connection and network traffic, the connection may disconnect when online media sources are playing.

Multimedia connections

USB adapter

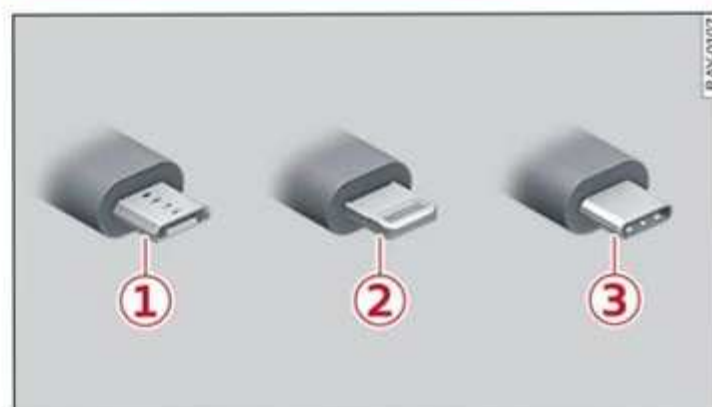

Fig. 157 Audi Genuine Accessories: USB adapter

You can connect your mobile devices to the MMI using the USB ports with charging function with a USB adapter, and charge the battery at the same time.

You can purchase the USB adapter cable from an authorized Audi dealer or at specialty stores:

- ① USB adapter for devices with a micro USB connection
- ② USB adapter for Apple devices with a Lightning connection
- ③ USB adapter for devices with USB type C connection

Note

Handle the USB adapter carefully. Do not allow it to be pinched.

Tips

Apple devices with a dock connector can only be charged using a USB adapter designed for devices with a dock connector. Data cannot be transmitted.

USB ports with charging function

Connect your mobile devices to the USB ports in order to operate the devices through the MMI and charge the batteries.

The USB ports are located in the storage compartment under the front center armrest and are labeled with the  symbol. If multiple USB devices are connected to the USB ports (for example, a smartphone and a USB flash drive), any of these devices can be used as the playback source.

Connecting or charging mobile devices using a USB adapter

- ▶ Connect the matching USB adapter to a USB port and to the mobile device, such as a smartphone.

The battery will charge automatically.

Mobile devices connected to the USB ports are started and operated using the MMI ⇒ *page 235*.

Disconnecting a mobile device from the USB port

- ▶ Remove the USB adapter cable from the USB port.

WARNING

Driving requires your complete and undivided attention. As the driver, you have complete responsibility for safety in traffic. Never operate mobile devices while driving, because this increases the risk of an accident.

Note

- Disconnect the connector from the USB port carefully to reduce the risk of damaging them.
- Use a USB extension cable to connect devices that have an integrated USB connector (such as a USB stick) to reduce the risk of damage to your USB device and the USB port.
- Extremely high or low temperatures that can occur inside vehicles can damage mobile

devices and/or impair their performance. Never leave mobile devices in the vehicle in extremely high or low temperatures.

Tips

- Always follow the information found in ⇒ *page 91*.
- When you switch the ignition off, the USB ports will still be supplied with power until the energy management system switches them off.
- Do not use additional adapter cables or USB extension cables to connect mobile devices to USB ports that already have a cable or that must be connected with a USB adapter cable (⇒ *page 233, fig. 157*). Using an additional adapter or US extension cable may impair functionality.
- Functionality is not guaranteed for mobile devices that do not conform to the USB 2.0 specification.
- USB hubs are not supported.
- Video playback ¹⁾ through the USB ports is not supported on Apple devices and MTP devices (such as smartphones).
- iPod touch or iPhone malfunctions also affect the operation of the MMI. Reset your mobile device in these situations.
- Audi recommends updating the iPod touch or iPhone software to the latest version. Refer to your mobile device owner's manual for more information.
- USB adapters on the USB ports will support iPod touch or iPhone devices from the 5th generation or newer with a lightning connector.
- A selection of supported devices can be found in the database for tested mobile devices at www.audi.com/mp3.

¹⁾ Picture playback for video files depends on the country in which this function is used.

Media playback¹⁾

Media sources

The following sources can be selected depending on the vehicle equipment:

- **USB device** ⇒ page 234.
- **Connect external device:** you can connect external devices via Bluetooth and use the Bluetooth audio player ⇒ page 232, or you can connect an external device directly to the USB port with charging function ⇒ page 234.
- **Streaming services** ⇒ page 233.

Accessing media

Playing media files using the MMI

- ▶ Applies to: MMI: Select on the home screen: **MEDIA > Source > a source**. Depending on the connected device or online media service*, the symbol for a source may change. The device name may be displayed (for example: my-Phone).
- ▶ Select a track from the categories in the media center ⇒ page 235.

Playing media files using the multifunction steering wheel

Requirement: a media source must contain media files ⇒ page 235.

- ▶ Select the radio/media tab in the instrument cluster.
- ▶ Press the  button to toggle between the radio and media or to select a different source.
- ▶ To select a media file/source, turn and press the left thumbwheel.

Playing media files using the Rear Seat Remote

Applies to: vehicles with Rear Seat Remote

- ▶ Applies to: Rear Seat Remote: Press **MEDIA** on the home screen.

Operation of the available media functions with the Rear Seat Remote is very similar to operation in the MMI ⇒ page 236.

Tips

- Applies to: MMI: For safety reasons, the video image is only displayed when the vehicle is stationary. Only the sound from the video plays while driving.
- Applies to: multifunction steering wheel: Depending on the selected function, operation through the MMI may be required.

Media center

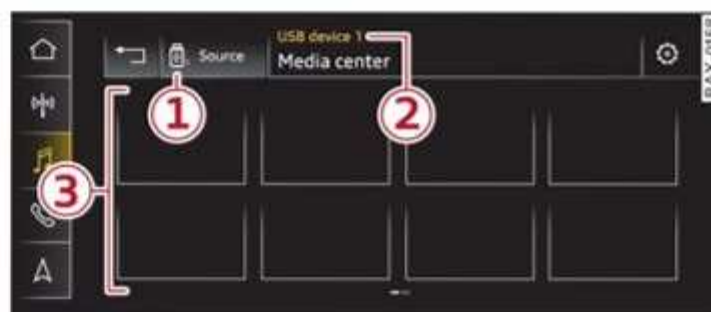

Fig. 158 Upper display: media center

There are various categories available in the media center. You can also search for media files across sources. The current music track continues playing while you search the MMI.

Opening the media center

- ▶ Applies to: MMI: Select on the home screen: **MEDIA > Source > a source > a category**.

① Source symbol

The symbol for the source that is currently in use is displayed. Depending on the connected device or online media service*, the source symbol may change. As an example, a USB stick is shown connected to the USB port with charging function.

② Source device name

The device name of the source that is currently in use is displayed.

③ Categories

The media center will display categories depending on vehicle equipment, the connected device, the content of the selected source, and the connection type: ▶

¹⁾ Picture playback for video files depends on the country in which this function is used.

- Last played tracks
- Artists
- Compilations
- Composers
- iTunes Radio
- Audio books
- Podcasts
- Genres
- Videos
- Tracks
- Albums

Other categories may be available depending on the service.

Playlists

All playlists and smart playlists in the source are displayed.

Smart playlists

- Last played tracks
- Most played tracks

Folders

The folder structure or track/chapter list is displayed.

Note
 Applies to: vehicles with Audi connect Infotainment

- Cloud services and the iTunes radio category always require an Internet connection.
- Read the information about Audi connect, and be sure to note the connectivity costs section ⇒ **Note** in *General information on page 203*.

Tips

- Only the categories supported by the medium/service are available.
- Applies to: MMI: For safety reasons, the video image is only displayed when the vehicle is stationary. Only the sound from the video plays while driving.
- When synchronizing a mobile device with Cloud services, playlists may display incorrectly in the MMI. Use the media center in the device.
- Applies to: iPod touch/iPhone: Note the information about the USB port with charging function and the supported devices ⇒ *page 233*.

Media functions

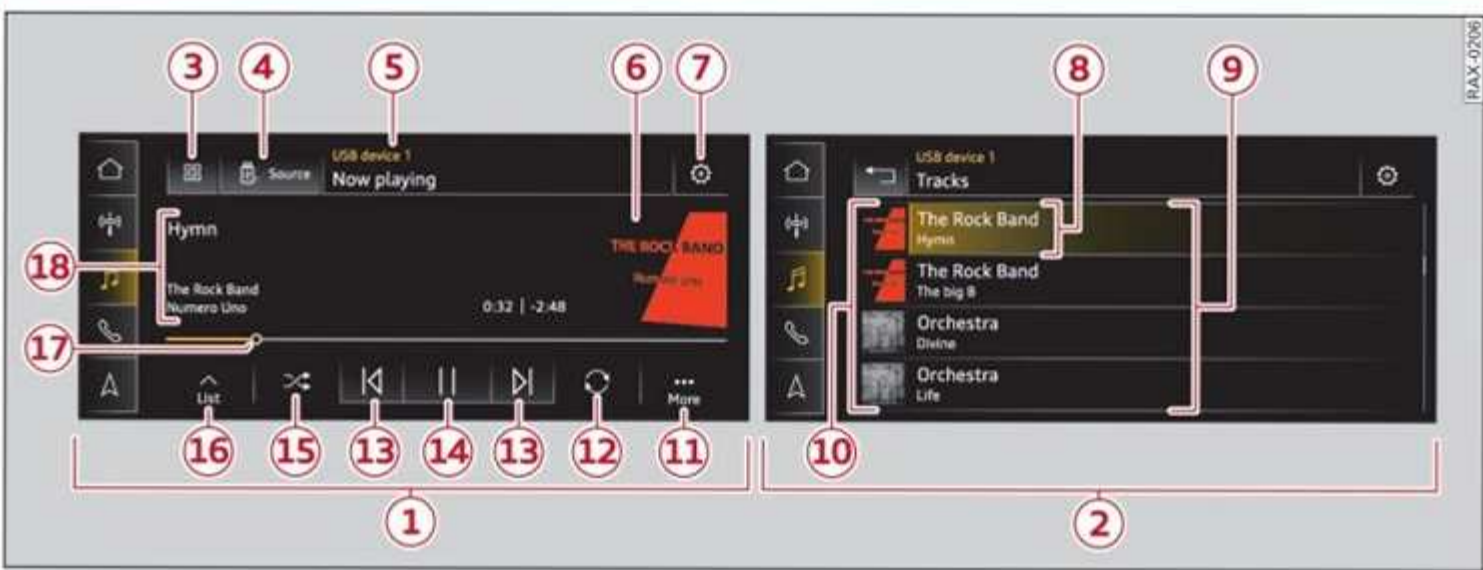









Fig. 159 Upper display: left side: playback view, right side: playlist

Operating

► Applies to: MMI: To open the playback view (1), select on the home screen: **MEDIA** > **Source** > a source > a category (for example, **Artists** > **Album**) > a track.

► To open the playlist (2), select **List** in the playback view (16).

Depending on the vehicle equipment and the selected media sources, the following functions may be available. ►

	Symbol/Description	Description
③		The media center categories are displayed based on the active source ⇒ <i>page 235</i> .
④	Source	Displays sources in the Media menu.
⑤	Source/device name	device name of the source that is currently playing.
⑥	Album cover in the playback view	Requirement: a media source with album covers must be selected or the covers must be available online ⇒ <i>page 238</i> , Online additional data . Displays the current album cover. Display the playlist: press on the cover.
⑦		Settings ⇒ <i>page 238</i> .
⑧	Current track information	Display of Track and Artist . Highlights the track that is currently playing.
⑨	List	Browsing in the list: drag your finger upward or downward.
⑩	Album cover in the playlist	Requirement: a media source with album covers must be selected or the covers must be available online ⇒ <i>page 238</i> , Online additional data . Displays the current album cover.
⑪	More	Opens options ⇒ <i>page 238</i> .
⑫	 Off	Switching between off/playlist/track: press ⑫.
	 Playlist	The tracks in the current playlist will repeat continuously in a loop.
	 Track	The current track will repeat continuously in a loop.
⑬		Selecting the previous/next track (or station/chapter): press ⏪ or ⏩. Fast forward/rewind: to fast forward or rewind within a track, press and hold ⏩ or ⏪. Jumping to the beginning of a track: press on ⏪ after the first three seconds of play time.
⑭		Start or stop playback
⑮		When this function is switched on, all files in the playlist will play in random order.
⑯	List	The playlist ② is displayed.
⑰	Playback position	The bar shows the current playback position in the track. Fast-forward or rewind: to fast forward or rewind within a track, move the bar to the right or left. Changing the playback position: press the desired playback position.
⑱	Info section	Display of Track , Artist , and Album .

Tips

Not all functions are available in every source and on every touch display.

Free text search

Applies to: vehicles with free text search

You can search across all active sources, for example for tracks and artists. ▶

Opening the search

Requirement: the selected source must support the search function.

- Applies to: MMI: Select on the home screen: **MEDIA > Search**.

Entries that contain the entered search term are listed in the results list. Each result is marked with the symbol for a category in the media center ⇒ *page 235*.

You can search for the following categories:

- Artists
- Albums
- Tracks
- Genres
- Videos

Options and settings

Options

Context-dependent functions and settings may be available depending on the country and vehicle equipment, the selected source, the connected mobile device, and the connection type.

Requirement: the playback view must be displayed ① ⇒ *page 236, fig. 159*.

- Press **More** ⑪.

Play more like this

The track currently playing is quickly analyzed for features such as artist, genre, mood, and beat, and a smart playlist with similar tracks will be shown.

Aspect ratio

Audi recommends the **Auto** setting for the picture format. If you press on an aspect ratio, you will see a preview of the setting on the screen. Press **OK** to apply the selected aspect ratio.

The following table gives an overview of the aspect ratios. The possible aspect ratios depend on the source or video file being played.

Aspect ratio	Description
Auto	The MMI detects the picture format of the source and displays the image in the optimal ratio.
4:3, 16:9	The image is fixed in the corresponding ratio. Select one of these options if the image is distorted or a section of the image is cut off or blurry when Auto is selected.
Zoom	The image is enlarged to fill the entire display.
Original	The image is displayed in the ratio of the source format. Select this option if the image is distorted or a section of the image is cut off or blurry when Auto is selected.

Settings

Accessing settings

- Applies to: MMI: Select on the home screen: **MEDIA > ⚙️**.

Depending on the vehicle equipment, the following settings may be available:

Online additional data

Requirement: the MMI must be connected to the Internet ⇒ *page 203, Audi connect*. Depending on the country, a data package may also be required ⇒ *page 208*.

When the function is switched on, additional information (such as album cover, artist, track) will be loaded depending on the availability.

Supported media and file formats

Overview

Depending on the country and vehicle equipment, media files with the following properties

may be supported by the connection for USB storage devices: ►

Audio/video files	
Supported media	USB ports with charging function: mobile devices ⇒ <i>page 233</i> such as iPhones, MTP players, and USB storage devices in “USB Device Sub-class 1 and 6” that conform to USB 2.0: USB sticks, USB MP3 players (Plug-and-Play capable), external USB flash drives, and hard drives
File system	USB storage devices: exFAT, FAT, FAT32, NTFS. USB storage device partitions (primary/logical*): 2 per USB connection.
Metadata	Album cover: GIF, JPG, PNG with max. 800x800 px. The album cover from the medium or from Gracenote* is displayed, depending on availability.
Playlists	.M3U; .PLS; .WPL; .M3U8; .ASX
Number of files	USB mass storage device: max. 50,000 files per medium; max. 1,000 files per playlist/folder

Audio files		
Format	File extension	
MPEG 1/2 Layer 3	.mp3	Up to maximum 320 kbit/s 48 kHz sampling frequencies
Windows Media Audio 9/10	.wma	
MPEG 2/4	.m4a; .m4b; .aac	
Opus	.opus; .ogg; .oga	
FLAC	.flac	48 kHz sampling frequency
ALAC	.m4a	
Monkey's Audio	.ape	

Video files		
Format	File extension	
MPEG 1/2	.mpg; .mpeg	Up to maximum 15 Mbit/s and 1920x1080 px at maximum 30 fps
MPEG4 AVC (H.264)	.mp4; .m4v; .mov; .avi	
Windows Media Video 9	.wmv; .asf	
MPEG-H (H.265/HEVC)	.mp4; .mov	
VP8/VP9	.webm	
Flash video	.flv; .f4v	

Tips

- The media sources do not support the Windows Media Audio 9 Voice format.
- For compressing MP3 files, Audi recommends a bit rate of at least 160 kbit/s. The display showing the remaining play time may differ for audio files with variable bit rate.
- Special characters (such as those in ID3 tag information) may display differently or may

not always display, depending on the system language.

- The manufacturer of the storage device can provide information about its “USB Device Subclass”.
- Some MTP player functions are not supported, such as rating music tracks and video playback.

Troubleshooting

The information that follows lists some troubleshooting options. They depend on the equipment.

Problem	Solution
USB ports with charging function/Bluetooth® audio player: the mobile device is not supported.	Read the instructions in the chapter ⇒ <i>page 233, Multimedia connections/⇒ page 232, Bluetooth audio player.</i>
USB ports with charging function: the mobile device is not recognized as a source.	For many mobile phones or mobile devices, playback is not possible when the battery level is too low (less than 5% charge level). The mobile device will only be recognized as a media source in the MMI after connecting if the battery charge level is sufficient.
USB ports with charging function: malfunctions during audio playback through an iPod touch/iPhone.	The Bluetooth® audio player function is switched on. Switch this function off ⇒ <i>page 246</i> when you are not using the Bluetooth® audio player .
USB ports with charging function: audio playback through the connected mobile device is not possible.	Make sure the USB mode <i>MTP</i> is selected in the settings on your mobile device.
Bluetooth® audio player: interference with track display and audio playback.	Playback interference can occur when using the Bluetooth® audio player if a music player app from a third party provider is open. Audi recommends using the integrated media player on your Bluetooth device (such as a smartphone).
Online media: no playback of online media.	Check if a data plan has been purchased for the applicable country and it is available ⇒ <i>page 208</i> .

Interactive experience

Themes¹⁾

Applies to: vehicles with themes

This function offers the option to customize the Infotainment system, for example by changing the background image.

Selecting a theme will change the appearance of the Infotainment system and the interior lighting if applicable.

Downloading themes

Requirements: You must have the myAudi app installed on your mobile device. You added your vehicle to the myAudi app. You are logged into the vehicle with your myAudi user.

- ▶ Open the myAudi app and download the desired theme.

Managing themes

Requirement: you have already downloaded a theme.

- ▶ Choose your desired theme in the myAudi app, or
- ▶ Applies to: MMI: To activate a theme, select on the home screen: **THEMES** > *a theme*.
- ▶ Applies to: MMI: To go back to the default appearance, select on the home screen: **SETTINGS** > **Display & Brightness** > **MMI** > **Themes** > **Deactivate**.

Using as a screensaver

The screensaver will display the background image without showing the menu icons.

Requirement: you have already activated a theme.

- ▶ Applies to: MMI: Swipe to the right until the background image is displayed without menu icons.

holoride interface

Applies to: vehicles with holoride interface

With a compatible virtual reality headset (VR headset) you can experience content such as games, movies, and presentations in a virtual world, while seated in the outer sections of the rear bench seat. The holoride interface connects the driving movements of the vehicle (such as acceleration, braking, and steering) with a virtual environment and in this way offers a virtual experience that imitates reality.

Limitations

The following requirements must be met in order to use holoride:

- ▶ The person using the system is seated in one of the outer seating positions in the rear bench seat.
- ▶ The person using the system is at least 5 feet (1.5 m) tall.
- ▶ The person using the system cannot touch any objects located in front of them (such as the back of the front seats) when they stretch their arms and fingers all the way out.
- ▶ The person using the system is using a VR headset with the necessary accessories for in-car use.

Requirements

- ▶ You have a compatible VR headset.
- ▶ You have installed the myAudi app on your mobile device and you have registered your vehicle in the myAudi app.
- ▶ You are logged into the vehicle with your myAudi user.
- ▶ You have installed the holoride app on your VR headset.

Setup

- ▶ Have the driver switch the ignition on.
- ▶ Place the VR headset on your head and start the holoride app on your VR headset.
- ▶ Start the myAudi app on your mobile device and follow the instructions. ▶

¹⁾ The function or equipment that is described was in development at the time this manual was published and may not be available in your vehicle.

- ▶ Follow the instructions on the VR headset.

Device compatibility

Compatibility cannot be guaranteed for all types of VR headsets. The availability depends on the following factors, among others:

- Brand and design of the VR headset.
- Software version of the holoride app used

WARNING

- Incorrect use increases the risk of injuries or an accident.
- Using the VR headsets in any location other than the outer sections of the rear bench seat increases the risk of serious injury during an accident.
- Pay attention to the safety precautions displayed in the holoride app in the VR headset.
- As the driver, do not let holoride users distract you from driving, as this could increase the risk of an accident.

Note

Always follow the information found in  in *General information on page 203*.

Smartphone interface

Setup

Applies to: vehicles with smartphone interface

You can connect your smartphone to the MMI with a cable or wirelessly* using the smartphone interface. Certain content on your smartphone is adapted in the MMI while driving and can be operated through the MMI.

Connecting smartphones with a cable

Requirement: the vehicle must be stationary and the ignition must be switched on. An iPhone from the 6th generation or newer with lightning connection must have the latest operating system installed or a smartphone with Android Auto app must have Android 5.0 Lollipop or newer installed.

- ▶ Connect your smartphone to the USB port with charging function ⇒ *page 234* using a USB adapter ⇒ *page 233, fig. 157*.

Connecting smartphones wirelessly

Applies to: vehicles with wireless Apple CarPlay/wireless Android Auto

Requirement: the vehicle must be stationary and the ignition must be switched on. An iPhone from the 6th generation or newer with lightning connection must have the latest operating system installed or a smartphone with Android Auto app must have Android 11 or newer installed.

- ▶ To connect your smartphone wirelessly, switch on the Bluetooth function and Wi-Fi on your smartphone.
- ▶ Applies to: Apple CarPlay: Open the Apple CarPlay settings in your iPhone.
- ▶ Applies to: Android Auto: Make sure that wireless Android Auto is allowed in the app settings in your smartphone.
- ▶ Enable the Bluetooth function and visibility on the MMI ⇒ *page 247*.
- ▶ Applies to: MMI: Select on the home screen: **SETTINGS > Connected devices > Smartphone interface > New connection**.
- ▶ In the MMI, press on your smartphone in the list of displayed devices.
- ▶ To update the list, press ↻.

Establishing a wired/wireless* connection

- ▶ Follow the system instructions if necessary.
- ▶ Pay attention to any additional system prompts on your smartphone, if applicable.
- ▶ Applies to: MMI: If you declined use of Apple CarPlay or Android Auto the first time you connected your smartphone, then select on the home screen: **SETTINGS > Connected devices > Smartphone interface > a smartphone**.
- ▶ Follow the system instructions.

WARNING

Driving requires your complete and undivided attention. As the driver, you have complete responsibility for safety in traffic. Never operate mobile devices while driving, because this increases the risk of an accident.

Note

Read the information about Audi connect, and be sure to note the connectivity costs section ⇒ *page 203*.

Tips

- The functions that can be used depend on the following factors, among others:
 - The brand of your smartphone
 - The version of the operating system in your smartphone
 - The software version of the app used
 - The USB adapter cable and correct connection
 - Your cell phone service provider
 - The customized settings on your smartphone
- One of the factors above or a combination of any of them could cause incompatibility with the smartphone interface. Compatibility cannot be guaranteed for all types of smartphones. For more information and assistance, refer to the user guide and the manufacturer of your smartphone.
- Please note that in order to use the smartphone interface, you can only connect your smartphone via the front USB port with charging function.

- Wireless Apple CarPlay*/wireless Android Auto* is not available in all countries.
- Wireless Apple CarPlay*/wireless Android Auto* is only possible in vehicles without a navigation system or without a detected vehicle position (GPS data) if the following requirement is met: the embedded SIM card for the vehicle must be logged into the mobile phone network ⇒ *page 204*.
- If the connected smartphone has voice control, you can operate your smartphone using the external voice recognition system ⇒ *page 32*.
- The MMI uses the menu language selected in your smartphone settings.

- Some MMI functions are not available when there is an active smartphone interface connection.
- You cannot connect any mobile devices via Bluetooth when a smartphone interface connection is active.
- Usage of the smartphone interface depends on the availability of services through third party providers.
- Audi merely provides access to third party services through the MMI and does not assume any responsibility for the content of these services.

Troubleshooting

Applies to: vehicles with smartphone interface

The information that follows lists some troubleshooting options. They depend on the equipment.

Problem	Solution
Smartphone interface cannot be opened.	Check the battery charge level on your smartphone. Check the USB adapter and use a different one if necessary. Check if Android Auto or Apple CarPlay is available in the country where the vehicle is being operated.
	Android Auto: check if the Android Auto app is installed on your smartphone.
Connecting the smartphone to the MMI failed.	Make sure that you are using the correct USB adapter and check if the USB adapter is connected correctly to your smartphone and the USB port with charging function ⇒ <i>page 233</i> .
	Apple CarPlay: check if Apple CarPlay is activated on your iPhone.
	Android Auto: check in the Android Auto app if Android Auto permits new vehicles.

Problem	Solution
Wireless connection between the smartphone and the MMI failed.	Apple CarPlay: open the settings for Bluetooth and Apple CarPlay on your iPhone. Remove your vehicle.
	Android Auto: open the settings for Bluetooth on your smartphone. Remove your vehicle. Also remove your vehicle in the Android Auto app.
	Open the Connected devices menu ⇒ <i>page 247</i> . Delete your smartphone in the Telephone 1 and smartphone interface menu items. Repeat the connection process. Restart the MMI ⇒ <i>page 22</i> . Restart your smartphone. Open the Wi-Fi settings in your smartphone. Check if your smartphone has connected to the 5 GHz vehicle Wi-Fi. Try connecting to the 5 GHz Wi-Fi manually.
The smartphone is not automatically detected.	Make sure that you are using the correct USB adapter and check if the USB adapter is connected correctly to your smartphone and the USB port with charging function ⇒ <i>page 233</i> . Check if the requirements needed to connect a smartphone have been met.

Additional settings

System settings

Introduction

General settings are described in this chapter. You can find specific settings in the chapters about those settings. The available settings depend on the vehicle equipment.

Date and time

- ▶ Applies to: MMI: Select on the home screen: **SETTINGS > General > Date & time.**

Possible settings:

- Automatically set date and time
- Date
- Time
- Date format
- Time format
- Automatic time zone
- Time zone

Measurement units

- ▶ Applies to: MMI: Select on the home screen: **SETTINGS > General > Measurement units.**

Possible settings:

- Speed
- Distance
- Temperature
- Volume
- Pressure
- Consumption (engine)

Language and keyboard

- ▶ Applies to MMI: Select on the home screen: **SETTINGS > Language & Keyboard.**

Language

You can change the languages for the display, navigation announcements, and the voice recognition system.

Keyboard

See ⇨ *page 27.*

Sound

Requirement: an audio source must be active.

- ▶ Applies to MMI: Select on the home screen: **SETTINGS > Sound.**
- ▶ Applies to: Rear Seat Remote: Select on the home screen: **SOUND.**

Possible settings:

- Treble
- Bass
- Balance/fader
- Speed dependent volume control
- Subwoofer
- Surround level
- Focus
- 3D effect

Announcements and tones

- ▶ Applies to: MMI: Select on the home screen: **SETTINGS > Announcements & Tones.**

Possible settings:

- Announcement volume
- Welcome sound



WARNING

Adjust the volume of the audio system so that signals from outside the vehicle, such as police and fire sirens, can be heard easily at all times.



Tips

The volume is automatically adjusted to a pre-set level when the MMI is switched on.

Bluetooth

- ▶ Applies to MMI: Select on the home screen: **SETTINGS > Connection settings > Bluetooth® ▶**

- ▶ Applies to: Rear Seat Remote: Select on the home screen: **SETTINGS** > **Connection** > **Bluetooth®**.

Bluetooth

Applies to: MMI: You can select a setting for visibility of the MMI to other Bluetooth devices. To connect a new Bluetooth device, the **Visible** setting must be selected. If **Invisible** is selected, a Bluetooth connection will only be possible with paired devices. If **Off** is selected, no Bluetooth device can be connected.

Bluetooth audio player

Applies to: MMI: When this function is switched on, the profile will load automatically when your Bluetooth audio player is within range.

Bluetooth® name

Applies to: MMI: The MMI's Bluetooth name is displayed and can be changed.

Applies to: Rear Seat Remote: The MMI's Bluetooth name is displayed.

Tips

The *name of the Wi-Fi hotspot* and the *Bluetooth name* are automatically compared when there are changes.

Factory default settings

Requirement: the ignition must be switched on.

- ▶ Applies to MMI: Select on the home screen: **SETTINGS** > **System maintenance** > **Restore factory settings**.
- ▶ Follow the system instructions.

The settings will be reset. The system will restart. This may take some time.

Tips

Make sure that not only the settings were deleted but also the stored data, if applicable.

Software update

Introduction

Applies to: vehicles with software update

You can update your vehicle's software.

The functions depend on the country and vehicle equipment:

- Map material update for the navigation system
⇒ *page 220*.
- Have the software update performed by an authorized Audi dealer or authorized Audi Service Facility. This can result in additional costs.

WARNING

- Perform the installation only when the vehicle is stationary. Otherwise, this increases the risk of an accident
- If the installation fails, contact an authorized Audi dealer or authorized Audi Service Facility immediately to have the malfunction corrected.

Connected devices

Displayed connected devices

Requirement: the vehicle must be stationary and the ignition must be switched on.

- ▶ Applies to: MMI: Select on the home screen: **SETTINGS** > **Connected devices**.

Possible menu items:

- Telephone 1
- Telephone 2
- Audio player
- Wi-Fi hotspot
- Headset

Smartphone interface

You can connect your smartphone to the MMI
⇒ *page 243*.

myAudi app

This function is available if an appropriate Audi app is installed on your mobile device and started, and if the mobile device is connected to the vehicle's Wi-Fi hotspot. ▶

Note

Read the information about Audi connect, and be sure to note the connectivity costs section ⇒ *page 203*.

Managing connected devices

Requirement: the connected devices menu must be displayed ⇒ *page 247*.

Connecting a device

Requirement: Bluetooth visibility must be activated in the MMI ⇒ *page 247* and mobile device.

- ▶ Press on a menu item, such as **Telephone 1**.
- ▶ To search for and connect your mobile device, press **New connection** ⇒ *page 190*.

Selecting a connected device

- ▶ Press on a menu item, such as **Telephone 1**.
- ▶ Press on the desired mobile device in the list of displayed devices. The connection will be made.

Disconnecting a connected device

- ▶ Press on a menu item, such as **Telephone 1**.
- ▶ Press on the connected mobile device. The selected mobile device will be disconnected from the MMI.

Deleting a device

- ▶ Press on a menu item, such as **Telephone 1**.
- ▶ Press and hold an element until the **Options** menu is displayed.
- ▶ Press **Delete**.

If a device is listed multiple times, it will be deleted from all menu items.

Tips

Audi recommends not connecting more than six devices. Regularly delete devices that are no longer used.

Additional options

Depending on the selected function, additional options may be available.

Requirement: the connected devices menu must be displayed ⇒ *page 247*.

- ▶ Press on a menu item, such as **Telephone 1**.
- ▶ Press and hold an element until the **Options** menu is displayed.

Bluetooth® profiles

You can switch desired profiles on or off separately in the MMI.

Favorite

To set a paired mobile device as the default phone, activate this function in the MMI.

When the mobile device is in range and the Bluetooth function on the mobile device and in the MMI is switched on, the default phone will be given priority over the other Bluetooth devices and will be connected directly to the MMI.

Legal information

General information

Information on the software licenses can be found online at www.audi.com/softwareinfo.

Multi Media Interface

- ▶ Applies to: MMI: Select on the home screen: **SETTINGS** > **General**.

Licenses

Version information

Legal notes

Possible options:

- **Software information**
- **About Audi connect**
- **About the data memory**

Rear Seat Remote

Applies to: vehicles with Rear Seat Remote

- ▶ Applies to: Rear Seat Remote: Select on the home screen: **SETTINGS**.

Possible options:

- **Software information**

– Legal notes

Smartphone interface

Applies to: vehicles with smartphone interface

Requirement: a smartphone must be connected to the MMI ⇨ *page 243*.

- ▶ Applies to: MMI: Select on the home screen: **SETTINGS > Connected devices > Smartphone interface**.
- ▶ Press and hold an element until the **Options** menu is displayed.
- ▶ Press **Legal notes**.

Instrument cluster

Requirement: the vehicle must be stationary and the ignition must be switched on.

- ▶ Select in the instrument cluster: vehicle functions tab ⇨ *page 16*.
- ▶ Press and hold the  button on the multifunction steering wheel until the display appears.

Possible options:

- **Engine code**
- **Software information**
- **Version information**

Head-up display

Applies to: vehicles with head-up display

Requirement: the vehicle must be stationary and the ignition must be switched on. The head-up display is switched on.

- ▶ Applies to: MMI: Select on the home screen: **SETTINGS > Display & Brightness > Head-up display > Display contents > Show the license text in the head-up display**.

Audi connect apps

Applies to: vehicles with Audi connect apps

- ▶ Applies to: MMI: Select on the home screen: **SETTINGS > Audi connect settings**.

In the submenus, you can find legal notes, software information, license information, and version information.

Checking and Filling

Fuel

Types of gasoline

The correct gasoline grade is stated on the inside of the fuel filler door.

The vehicle is equipped with a catalytic converter and must only be driven with **unleaded gasoline**.

Audi recommends using TOP TIER Detergent Gasoline. For additional information on TOP TIER Detergent Gasoline, visit www.toptiergas.com.

The individual gasoline grades are differentiated by **octane ratings**. This value is given with (R+M)/2 equating to AKI or in RON.

The headings below match the sticker in the fuel filler door (examples):

UNLEADED FUEL ONLY MIN. (R+M)/2 87 Regular / MIN. RON 91 Regular

Use regular gasoline with minimum 87 AKI / 91 RON ⇨ .

Audi recommends using premium gasoline with minimum 91 AKI / 95 RON to achieve the rated horsepower and torque.

UNLEADED FUEL ONLY PREMIUM MIN. (R+M)/2 91 / SUPER MIN. RON 95

Using premium gasoline with minimum 91 AKI / 95 RON is recommended.

If premium gasoline is not available, you can also use regular gasoline 87 AKI / 91 RON. However this does reduce the engine power slightly.

UNLEADED FUEL ONLY PREMIUM MIN. (R+M)/2 93 / SUPER PLUS MIN. RON 98

Using premium plus gasoline with at least 93 AKI / 98 RON is recommended.

If no premium plus gasoline is available, you can also use premium gasoline with 91 AKI / 95 RON. However this does reduce the engine power slightly.

Note

- Filling the tank just one time with leaded fuel or other metallic additives will cause permanent deterioration to the catalytic converter function.
- When gasoline with an octane rating that is too low is used, high speeds or heavy engine load can lead to engine damage.

Tips

The vehicle may be filled with fuel that has a higher octane rating than what is required by the engine.

Gasoline mixture

Gasoline with alcohol (ethanol)

You can fuel your vehicle with unleaded gasoline that has an ethanol content of up to 15%, for example “E15”.

Gasoline adapted to the season

Many gasoline fuels are adapted to the seasons. When the season changes, refueling at high-traffic gas stations is recommended. It is more likely that the gasoline will be suitable for the season there.

Note

- Do not use gasoline that does not meet the specifications.
- Ethanol fuels with a high ethanol percentage, such as E30 – E100, must **not** be used. The fuel system will be damaged!
- Methanol fuels with a high methanol percentage, such as M5 – M100, must **not** be used. The fuel system and the engine will be damaged!
- If you are unable to find out if a specific gasoline mixture meets the specifications, ask the gas station operator or their fuel supplier.
- Do not use any gasoline mixture whose composition cannot be identified.
- Audi does not assume any responsibility for damage to the fuel system or for performance problems caused by using gasoline

mixtures different from those specified. This type of damage also does not fall under the New Vehicle Limited Warranty or under the emissions control system warranty.

- If you notice a higher fuel consumption or poor handling or performance problems due to such gasoline mixtures, Audi recommends fueling with unblended gasoline.

Gasoline additives

An important issue for many automobile manufacturers is combustion residue in the engine that results from the use of certain fuels.

Although types of gasoline differ depending on the manufacturer, there are similarities. Certain substances in the gasoline may cause deposits in the engine. Additives in the gasoline that should keep the engine and fuel system clean do not all function equally.

Audi recommends using TOP TIER Detergent Gasoline. For additional information on TOP TIER Detergent Gasoline, visit www.toptiergas.com.

If you use incorrect fuels over a long period of time, the maximum engine performance may be impaired by combustion residue.

Note

- Damage or malfunctions caused by the use of incorrect types of gasoline are not covered by the New Vehicle Limited Warranty.
- Only gasoline additives that have been approved by Audi may be used.

Refueling

Messages

The following messages may appear depending on the vehicle equipment:

Messages

If the  indicator light appears with a corresponding message, refuel the vehicle.

 **Tank system: malfunction! Please contact Service**

There is a malfunction in the fuel tank system. Drive to an authorized Audi dealer or authorized Audi Service Facility immediately to have the malfunction corrected.

Fueling detected. Reset mi (km) now?

Select **Yes** if you would like to reset the trip odometer.

The message appears in the instrument cluster depending on the fuel level in the tank and the amount of fuel added.

Fueling procedure



Fig. 160 Right rear side of the vehicle: opening the fuel filler door



Fig. 161 Fuel filler door with attached fuel cap

The fuel filler door is unlocked or locked by the central locking system.

- ▶ Unlock the vehicle if necessary.
- ▶ Press on the left side of the fuel filler door to open it ⇒ *fig. 160*.
- ▶ Unscrew the tank cap counterclockwise.
- ▶ Place the cap from above on the open fuel filler door ⇒ *fig. 161*.
- ▶ Insert the fuel pump nozzle all the way into the fuel filler neck.
- ▶ Begin fueling. Once the fuel pump nozzle turns off the first time, the fuel tank is full. Do not ▶

continue fueling, or else the expansion space in the tank will be filled with fuel.

- ▶ After the fuel pump has switched off, wait five seconds before removing the nozzle to allow the rest of the fuel to finish dripping into the fuel tank.
- ▶ Turn the fuel cap clockwise until it clicks into place.
- ▶ Close the fuel filler door and then press on the left side until it latches.

The correct fuel type for your vehicle can be found on a label located on the inside of the fuel filler door. For additional information on fuel, see ⇒ *page 250*.

For the tank capacity in your vehicle, refer to the Technical Data ⇒ *page 323*.

To reduce the risk of fuel leaking out or vapors escaping, make sure that the fuel tank is closed correctly. Otherwise the ¹⁾ indicator light will turn on.

WARNING

Improper fueling procedures and improper handling of fuel can lead to explosions, fires, severe burns, and other injuries.

- Do not smoke. Keep away from open flames.
- The ignition must be switched off when refueling.
- Mobile devices, radio devices, and other radio equipment should always be switched off when refueling. Electromagnetic rays could cause sparks and start a fire.
- If you do not insert the fuel pump nozzle all the way into the filler tube, then fuel can leak out. Spilled fuel can ignite and start a fire.
- Never get into the vehicle when refueling. If there is an exceptional situation where you must enter the vehicle, close the door and touch a metal surface before touching the fuel pump nozzle again. This will reduce the risk of electrostatic discharge that can cause flying sparks. Sparks can start a fire when refueling.

WARNING

Audi does not recommend transporting fuel containers inside the vehicle. Fuel could leak out of the container and ignite, especially during an accident. This can cause explosions, fires, and injuries.

- If you must transport fuel in a fuel container, note the following:
 - Always place the fuel container on the ground before filling. Never fill the fuel container with fuel while it is inside or on the vehicle. Electrostatic discharge can occur while refueling and the fuel vapors could ignite.
 - When using fuel containers made of metal, the fuel pump nozzle must always remain in contact with the container to reduce the risk of static charge.
 - Insert the fuel pump nozzle as far as possible into the filler opening while refueling.
 - Follow the applicable legal regulations in the country where you are driving when using, storing and transporting fuel containers.
 - Make sure that the fuel container meets the industry standards, for example ANSI or ASTM F852-86.

Note

- Remove fuel that has overflowed onto any vehicle components immediately to reduce the risk of damage to the vehicle.
- Never drive until the fuel tank is completely empty. The irregular supply of fuel that results from that can cause engine misfires. Uncombusted fuel may enter the exhaust system and increase the risk of damage to the catalytic converter.

For the sake of the environment

- Do not overfill the fuel tank, or fuel could leak out when the vehicle is warming up.
- Fuel should never enter the sewer system or come into contact with the ground. ▶

¹⁾ Depending on the engine and country

i Tips

The fuel filler door on your vehicle does not lock if you lock the vehicle from the inside using the central locking switch.

Fuel filler door emergency release

- ▶ See an authorized Audi dealer or authorized Audi Service Facility if you cannot open the fuel filler door.
- ▶ Afterward, drive to an authorized Audi dealer or authorized Audi Service Facility to have the malfunction repaired.

Emissions control system

General information

! WARNING

The temperature of the exhaust system is high, both when driving and after stopping the engine.

- Never touch the exhaust tail pipes once they have become hot. This could result in burns.
- Do not park your vehicle over flammable materials such as grass or leaves because the high temperature of the emissions system could start a fire.
- Do not apply underbody protectant in the exhaust system area, because this increases the risk of fire.

Catalytic converter

Observe the safety precautions ⇒ page 253, General information.

The vehicle may only be driven with unleaded gasoline, or the catalytic converter will be destroyed.

Never drive until the tank is completely empty. The irregular supply of fuel that results from that can cause engine misfires. Uncombusted fuel could enter the exhaust system, which could

cause overheating and damage to the catalytic converter.

Malfunction Indicator Lamp (MIL)

If the  indicator light blinks or turns on, there is a malfunction related to emissions which can, for example, cause poor emissions quality and damage to the catalytic converter. Drive slowly to an authorized Audi dealer or authorized Audi Service Facility to have the malfunction corrected.

The indicator light can also turn on if the fuel filler cap is not closed correctly ⇒ page 251¹⁾.







Engine compartment

General information

Special care is required if you are working in the engine compartment

For work in the engine compartment, such as checking and filling fluids, there is a risk of injury, scalding, accidents, and burns. For this reason, follow all the warnings and general safety precautions provided in the following information. The vehicle's engine compartment is a dangerous area. ⇒ !.

Explanation of warning symbols:

	Observe all warnings - there is a risk for injury!
	Hot motor components! Rotating parts!
	The radiator fan can switch on at any time!
	High voltage! Switch off the engine before coming into contact with any ignition system components!
	The catalytic converter can be damaged if the oil level is too high!
	Hot coolant - there is a risk of scalding!
	Always follow the instructions in the operating manual.

¹⁾ Depending on the engine and country

WARNING

- Turn the engine off.
- Switch the ignition off.
- Set the parking brake.
- Select the “P” (Park) selector lever position.
- Allow the engine to cool.
- Keep children away from the engine compartment.
- Never spill fluids on a hot engine. These fluids (such as the freeze protection contained in the coolant) can catch fire.
- Avoid short circuits in the electrical system.
- Never reach into the radiator fan. The fan is temperature-controlled and can turn on suddenly, even when the ignition is switched off.
- Never open the hood when there is steam or coolant escaping from the engine compartment, because there is a risk that you could be burned. Wait until no steam or coolant is escaping.
- The cap on the coolant expansion tank must never be opened when the coolant is hot. The cooling system is under pressure. There is a risk of burns
- To protect your face, hands, and arms from hot steam or coolant, cover the cap with a thick cloth when opening.
- Do not remove the engine cover under any circumstances. This increases the risk of burns.
- Due to the risk of electric shock, never touch the ignition cable or other components in the electronic high-voltage ignition system when the engine is running or is starting.
- If a gear is engaged while the vehicle is stationary and the engine is running, do not press the accelerator pedal inadvertently. Pressing the accelerator pedal will cause the vehicle to move, and this could result in an accident.
- If inspections or repairs must be performed while the engine is running, moving components (such as the ribbed belt, generator, and radiator fan) pose an additional risk.
 - Set the parking brake first and select the “P” (Park) selector lever position.

- Always make sure that no parts of the body, jewelry, ties, loose clothing, and long hair can be caught in moving engine components. Before any work, always remove any jewelry and/or ties, tie back long hair, and make sure all clothing fits close to the body to reduce the risk of anything becoming caught in engine components.
- Pay attention to the following warnings listed when work on the fuel system or on the electrical equipment is required.
 - Do not smoke.
 - Never work near open flames.
 - Always have a working fire extinguisher nearby.
- All work on the battery or electrical system in your vehicle can result in injuries, chemical burns, accidents, or burns. Because of this, all work must be performed **only** by an authorized Audi dealer or authorized Audi Service Facility.
- Limit your exposure to exhaust and chemicals to as short a time as possible.

WARNING

California Proposition 65 Warning:

- Engine exhaust, some of its constituents, and certain vehicle components contain or emit chemicals known to the State of California to cause cancer and birth defects and reproductive harm. In addition, certain fluids contained in vehicles and certain products of component wear contain or emit chemicals known to the State of California to cause cancer and birth defects or other reproductive harm.
- Battery posts, terminals and related accessories contain lead and lead compounds, chemicals known to the State of California to cause cancer and reproductive harms. Wash hands after handling.

Note

When filling fluids, be sure not to add any fluids to the wrong reservoirs. Otherwise severe malfunctions and engine damage will occur. ▶

 **For the sake of the environment**

You should regularly check the ground under your vehicle in order to detect leaks quickly. If there are visible spots from oil or other fluids, bring your vehicle to an authorized Audi dealer or authorized Audi Service Facility to be checked.

Opening and closing the hood

The hood is released from inside the vehicle.



Fig. 162 Footwell: release lever





Fig. 163 Unlocked hood: lever

Observe the safety precautions ⇒ page 253, *General information*.

Make sure the wiper arms are not raised up from the windshield. Otherwise the paint could be damaged.

Opening the hood

- ▶ With the door open, pull the lever ¹⁾ below the instrument panel in the direction of the arrow ⇒ fig. 162.

- ▶ Raise the hood slightly ⇒ .
- ▶ Press the lever ⇒ fig. 163 in the direction of the arrow. This releases the hooks.
- ▶ Open the hood.

Closing the hood

- ▶ Push the hood down until you override the force of the strut.
- ▶ Let the hood fall lightly into the latch. *Do not press it in.* ⇒ .

Messages

The following messages may appear depending on the vehicle equipment:

 **Warning! Hood is not locked. Stop vehicle and check the lock**

The hood latch is not locked correctly. Stop immediately and close the hood.

 **WARNING**

- Never open the hood when there is steam or coolant escaping from the engine compartment, because there is a risk that you could be burned. Wait until no steam or coolant is escaping.
- For safety reasons, the hood must always be latched securely while driving. Because of this, always check the hood after closing it to make sure it is latched correctly. The hood is latched if the front corners cannot be lifted.
- If you notice that the hood is not latched while you are driving, stop immediately and close it, because driving when the hood is not latched increases the risk of an accident.

¹⁾ The  symbol is not available in all countries.

Engine compartment overview

The most important check points.

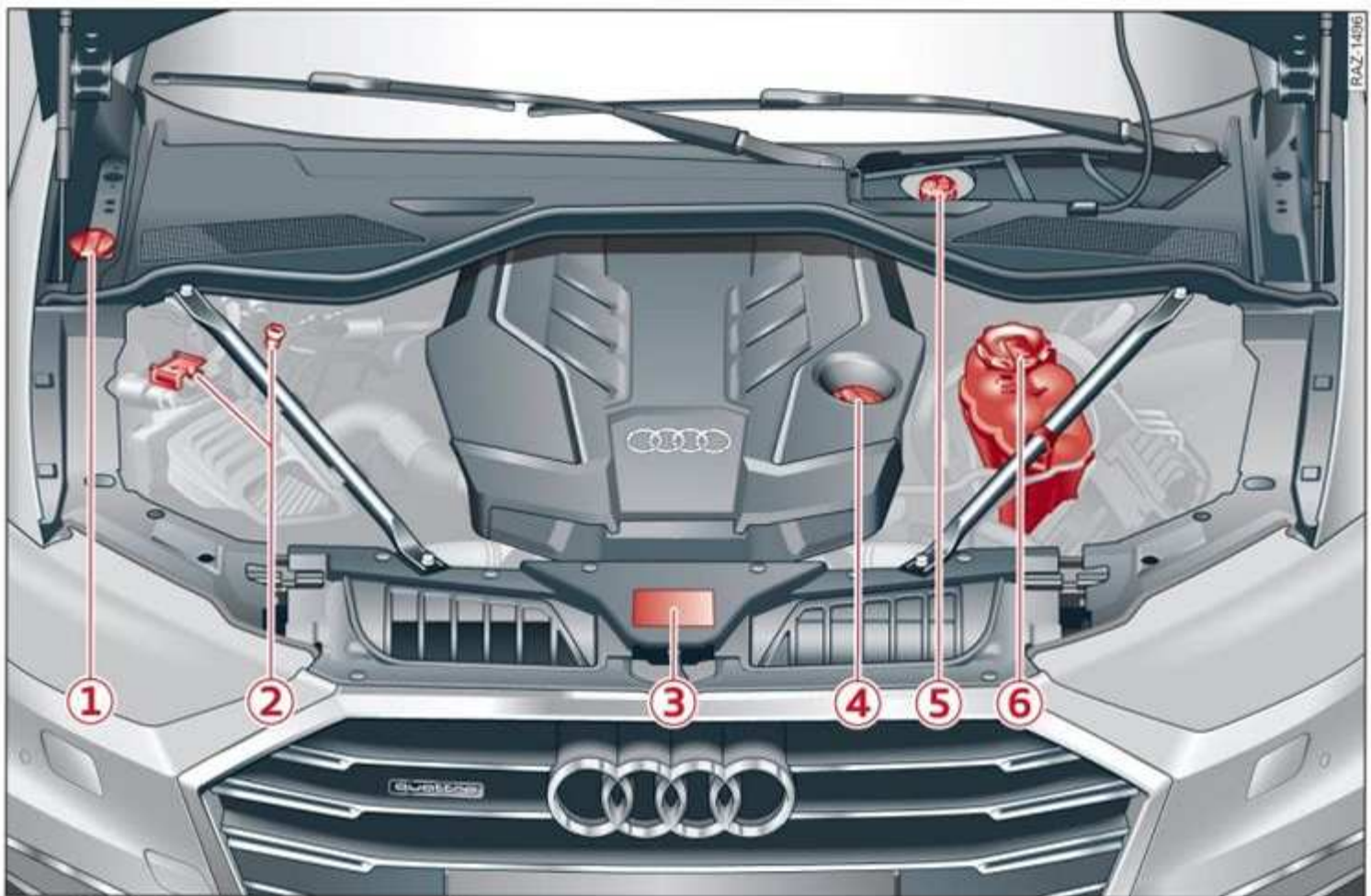

Fig. 164 Engine compartment overview: diagram

Observe the safety precautions ⇒ page 253, General information.

- ① Washer fluid reservoir (☞) ⇒ page 267
- ② Jump start point (+) under a cover, (-) with hex head screw ⇒ page 266, Charging the 12 volt vehicle battery ⇒ page 304, Jump starting
- ③ Sticker for engine oil specifications ⇒ page 256
- ④ Engine oil filler opening (☞) ⇒ page 258, Checking the engine oil level
- ⑤ Brake fluid reservoir (☞) under a cover ⇒ page 262
- ⑥ Coolant expansion tank for combustion engine (☞) ⇒ page 261

The engine oil filler opening may be located in a different area depending on the specific engine.

Engine oil

If the engine oil level is too low

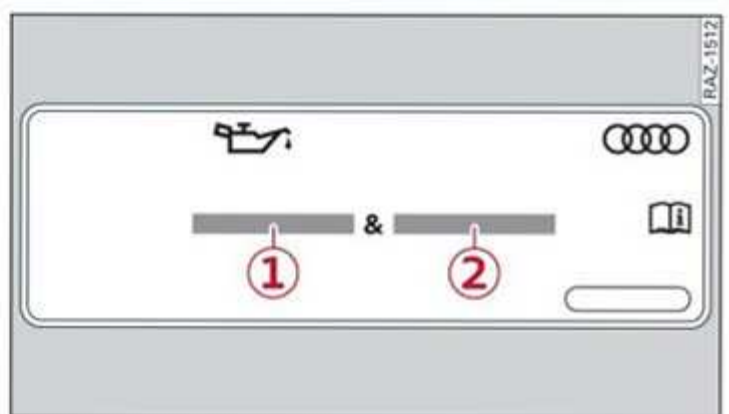

Fig. 165 Engine oil sticker

- ① Engine oil viscosity
- ② Engine oil standard

If you need to add engine oil, use an oil that meets the engine oil standard listed on the sticker ⇒ fig. 165. The sticker with the specified standard is located in the front of the engine compartment ⇒ page 256, fig. 164. When using ▶

the specified engine oil, you can adjust the oil level as often as needed.

If engine oil that meets the recommended specification is not available, **in an emergency** you may add a maximum of 0.5 quart (0.5 liter) engine oil of the that meets the following different standard **one time** until the next regular oil change.

- Standard VW 504 00, ACEA C3, ACEA C4, API SP or ILSAC GF-6A. All viscosity classes within these standards are permitted.

Audi recommends having the oil changed by an authorized Audi dealer or authorized Audi Service Facility.

 **Note**

Audi recommends using approved engine oil that meets the respective VW standard. Using engine oils which do not meet these quality standards can cause damage to the engine. As an exception and only in an emergency, 0.5 qt (0.5 l) of engine oil that differs from the standards listed may be used.

 **Tips**

Audi recommends using engine oils provided by Audi Genuine Parts.

Messages

The following messages may appear depending on the vehicle equipment:

 **Turn off engine. Oil pressure too low**

Stop driving and switch the engine off. Check the engine oil level ⇨ *page 258*.

- If the engine oil level is too low, add engine oil ⇨ *page 259*. Only continue driving once the indicator light turns off.
- If the engine oil level is correct and the indicator light still turns on, turn the engine off and do not continue driving. See an authorized Audi dealer or authorized Audi Service Facility for assistance.

 **Please add oil immediately**

Stop driving and switch the engine off. Check the engine oil level ⇨ *page 258* and add engine oil immediately ⇨ *page 259*.

 **Add max. x qt (x l) oil. You can continue driving**

Add the amount of oil shown immediately ⇨ *page 259*.

 **Please reduce oil level**

There is too much oil in the engine and there is a risk of damaging the catalytic converter or engine. Drive to an authorized Audi dealer or authorized Audi Service Facility immediately to have engine oil extracted if necessary. Avoid high engine speeds, full acceleration, and heavy engine loads.

 **Oil level sensor: oil change necessary. Please contact Service**

Fuel has entered the engine oil. This will cause the engine oil level to rise slowly and the engine oil quality to decrease. Do not extract engine oil to reduce the level, because this will increase the risk of engine damage. Drive to an authorized Audi dealer or authorized Audi Service Facility immediately to have engine oil extracted.

 **Oil level system: malfunction! Please contact Service**

The sensor that checks the engine oil level has malfunctioned. Drive immediately to an authorized Audi dealer or authorized Audi Service Facility to have the malfunction repaired.

 **Oil pressure sensor: malfunction! Please contact Service**

The sensor that checks the engine oil pressure has malfunctioned. Drive immediately to an authorized Audi dealer or authorized Audi Service Facility to have the malfunction repaired.

 **Please drive to warm up engine**

Especially low outside temperatures are a main reason why fuel may get into the engine oil. The fuel can only evaporate from the engine oil if the engine oil temperature is high enough.

Drive in the “S” gear. ▶

Drive the engine at higher RPMs while avoiding full acceleration.

You should drive for at least 30 minutes. The indicator light may not turn off during this time. Repeat the steps that are described at any time.

Have an authorized Audi dealer or authorized Audi Service Facility repair the malfunction if the indicator light does not turn off after a few drives.

WARNING

When the message  **Please drive to warm up engine** appears, adjust your speed according to the weather, road, terrain, and traffic conditions. You should never disobey the traffic laws applicable in the country in which you are driving in order to follow driving recommendations.

Tips

The oil pressure warning  is not an oil level indicator. Always check the oil level regularly.

Checking the engine oil level

The engine oil level can be checked in the MMI.

Observe the safety precautions ⇒ page 253, *General information*.

- ▶ Park the vehicle on a level surface.
- ▶ Shut the engine off when it is warm.
- ▶ Switch only the ignition back on.
- ▶ Wait approximately five minutes so that the engine oil can flow back into the engine oil pan.
- ▶ Applies to MMI: Select on the home screen: **VEHICLE > Settings & Service > Oil level**.
- ▶ Read the oil level in the display. Add engine oil if the bar in the oil level indicator is just below "min" ⇒ page 259.

Note

If the engine oil level is too low or too high, there is a risk of engine damage.

Tips

The oil level indicator in the display is only an informational display. If the oil level is too

low, a minimum oil warning appears in the instrument cluster. Add oil and close the hood. The current oil level will be displayed on the MMI the next time the ignition is switched on.

Tips

The engine oil consumption may be up to 0.5 quart/600 miles (0.5 liter/1,000 km), depending on driving style and operating conditions. Consumption may be higher during the first 3,000 miles (5,000 km). The engine oil level must be checked regularly. It is best to check each time you refuel your vehicle and before long drives.

- Because of the lubrication and cooling of the engine, combustion engines consume oil. The oil consumption varies depending on the engine and may change during the service life of the engine. Engines generally consume more oil at the beginning during the break-in period. Then oil consumption stabilizes after the break-in period.
- Under normal conditions, oil consumption depends on the quality and viscosity of the oil, the engine RPM, the climate conditions, and the road conditions. The dilution of oil from condensation or fuel residue as well as the age of the oil also play a role. Because engine wear increases with mileage, oil consumption will increase again over time until it may be necessary to replace worn components.
- Because all these variables play a role, it is not possible to define an oil consumption standard. Therefore, the oil level must be checked regularly.
- If you believe that your engine has increased its oil consumption, contact an authorized Audi dealer or authorized Audi Service Facility to determine the cause. Please note that an exact oil consumption measurement must be done with the necessary care and accuracy and may take time. An authorized Audi dealer or authorized Audi Service Facility is trained in accurately measuring the oil consumption.
- You can find information on engine oil and engine oil capacities for the USA at www.audi.com.

audiusa.com/help/maintenance, or for Canada at www.audi.ca/ca/web/en/customer-area/care-and-maintenance/audi-service-schedules.html, or call 800-822-2834.

Adding engine oil



Fig. 166 Engine compartment: engine oil filling opening cover (example)

Observe the safety precautions ⇒ *page 253, General information*.

- ▶ Turn the engine off.
- ▶ Open the hood ⇒ *page 255*.
- ▶ Unscrew the cap  for the engine oil filler opening ⇒ *fig. 166*.
- ▶ Carefully add 0.5 quart (0.5 liter) of the correct oil ⇒ *page 256*.
- ▶ Close the engine oil filler opening cap.
- ▶ Close the hood ⇒ *page 255*.
- ▶ Restart the ignition after two minutes and check the current oil level in the MMI ⇒ *page 258, Checking the engine oil level*.
- ▶ Applies to: using engine oil that meets the recommended specification: Add some more engine oil again if necessary.

WARNING

- When adding oil, do not let oil drip onto hot engine components. This increases the risk of a fire.
- You must close the cap on the oil filler opening correctly so that oil does not leak out onto the hot engine and exhaust system when the engine is running, because this is a fire hazard.
- Always clean skin thoroughly if it comes into contact with engine oil.

- Engine oil is poisonous and must be kept out of reach of children.
- Store the engine oil securely in the original container.

Note

- Only use high-grade engine oil that explicitly meets the Audi oil quality standard for your vehicle. Using another oil may cause severe vehicle damage.
- Do not mix any additives with the engine oil. Additives may cause engine damage that is not covered by your New Vehicle Limited Warranty.

For the sake of the environment

- Oil should never enter the sewer system or come into contact with the ground.
- Follow the legal regulations in the country where you are located when disposing of empty oil containers.

Changing engine oil

Audi recommends having the oil changed at an authorized Audi dealer or authorized Audi Service Facility.

Observe the safety precautions ⇒ *page 253, General information*.

The engine oil must be changed at the intervals specified in the Warranty & Maintenance Booklet. This is very important because the lubrication function of the oil gradually declines during regular vehicle operation.

The engine oil should be changed more frequently under certain circumstances. Have the oil changed more frequently if you often drive short distances, your vehicle is predominantly in stop-and-go traffic situations, is in very dusty environments, or is operated for long periods of time in temperatures below zero.

Cleansing additives in the oil make fresh oil appear darker after the engine has run briefly. This is normal and no reason to change the engine oil more frequently than recommended. ▶

Because correctly disposing of engine oil is difficult and special tools and technical knowledge are needed for an oil change, Audi recommends having your engine oil changed by an authorized Audi dealer or authorized Audi Service Facility.

If you change the engine oil yourself, please note the following important information:

WARNING

If you change the engine oil on the vehicle yourself, the following precautions must be followed:

- Wear protective eyewear.
- Due to the risk of scalding, allow the engine to cool down sufficiently.
- Maintain enough distance when you are removing the oil drain plug. While doing this, keep your forearm parallel to the ground to reduce the risk of hot oil dripping down your arm.
- Drain the oil into a container designed for this purpose that is large enough to hold the full amount of oil in your engine.
- Engine oil is poisonous. Always store out of reach of children.
- Prolonged contact of used engine oil with the skin may cause skin damage. Always wash oil off immediately with soap and water to protect your skin.

Note

Do not mix any additives with the engine oil. Additives may cause engine damage that is not covered by your New Vehicle Limited Warranty.

For the sake of the environment

- Before changing the engine oil, make sure you can dispose of the used engine oil correctly.
- Engine oil must always be disposed of correctly. Do not dump it in the yard, in the forest, or in open water, river channels, or sewers.
- Have your used engine oil recycled by bringing it to a used oil collection site or contact a gas station.

Cooling system

Coolant

The engine cooling system is filled with a mixture of purified water and coolant additive at the factory. This coolant must not be not changed.

The coolant level is monitored using the  indicator light. However, you should occasionally check the coolant level.

Messages

The following messages may appear depending on the vehicle equipment:

 **Turn off engine and check coolant level. See owner's manual**

The coolant level is too low.

Do not continue driving and switch the ignition off. Check the coolant level ⇒ *page 261*.

- If the coolant level is too low, add coolant ⇒ *page 261*. Only continue driving once the indicator light turns off.

 **Coolant temperature: too high. Please let engine run while vehicle is stationary**

Let the engine run at idle for a few minutes to cool off, until the indicator light turns off.

- If the indicator light does not turn off, do not continue driving the vehicle. See an authorized Audi dealer or authorized Audi Service Facility for assistance.

 **Coolant system: malfunction! Please turn off engine**

Do not continue driving, shut the engine off, and switch the ignition off. See an authorized Audi dealer or authorized Audi Service Facility for assistance.

Coolant additive

The coolant additive is made of anti-freezing and corrosion protection agents. Only add the following coolant additives mixed with distilled water.

Coolant additive	Specification
G12evo	TL 774 L

The amount of coolant additive that needs to be mixed with water depends on the climate where the vehicle will be operated. If the coolant additive percentage is too low, the coolant can freeze and damage the engine.

	Coolant additive	Freeze protection
Warm regions	min. 40% max. 45%	min. -13 °F (-25 °C)
Cold regions	min. 50% max. 55%	max. -40 °F (-40 °C)

Note

- Before the start of winter, have an authorized Audi dealer or authorized Audi Service Facility check if the coolant additive in your vehicle matches the percentage appropriate for the climate. This is especially important when driving in colder climates.
- If the G12evo coolant additive is not available in an emergency, do not add any other additive. You could damage the engine. If this happens, only use distilled water and restore the correct mixture ratio with the specified coolant additive as soon as possible.
- Only refill with new coolant.
- Radiator sealant must not be mixed with the coolant.
- You can continue driving if the permitted G12evo coolant additive was not added. However, go to an authorized Audi dealer or authorized Audi Service Facility immediately to have the coolant replaced to reduce the risk of engine damage.
- Due to the risk of engine damage, the cooling system should only be refilled by an authorized Audi dealer or authorized Audi Service Facility. An authorized Audi dealer or authorized Audi Service Facility can also provide you with important information about the recommended coolant additive.

Checking coolant



Fig. 167 Engine compartment - Coolant expansion tank (diagram): ① cover with release button; ② markings

Observe the safety precautions ⇒ page 253, General information.

Checking the coolant level

- ▶ Park the vehicle on a level surface.
- ▶ Switch the ignition off.
- ▶ Open the hood ⇒ page 255.
- ▶ Check the coolant level in the coolant expansion tank ⇒ page 256, fig. 164 using the outer markings ② ⇒ fig. 167. The coolant level must be between the markings ② when the engine is cold. When the engine is warm it can be slightly above the upper marking.
- ▶ When you add coolant to the expansion tank, please refer to ⇒ page 260, Cooling system.

Adding coolant

Requirement: there must be a residual amount of coolant in the expansion tank ⇒ !.

If you must add coolant, use a mixture of water and coolant additive. Audi recommends mixing the coolant additive with distilled water.

- ▶ Allow the engine to cool.
- ▶ Place a large, thick towel on the coolant expansion tank cap.
- ▶ Push the release button ① ⇒ fig. 167 on the cap and carefully turn it to the left until you feel resistance ⇒ ⚠.
- ▶ Push the release button again and remove the cap completely.
- ▶ Add coolant mixed in the correct ratio ⇒ page 260 up to the MAX marking.
- ▶ Make sure that the fluid level remains stable. Add more coolant if necessary.

- ▶ Turn the cap to the right to tighten it until you feel resistance a second time.

WARNING

- The engine compartment in any vehicle is a potentially dangerous area. Stop the engine, switch the ignition off, and allow the engine to cool before working in the engine compartment. Always follow the information found in ⇒ *page 253, General information*.
- Never open the hood if you can see or hear steam or coolant escaping from the engine compartment. This increases the risk of burns. The cooling system is under pressure. When you no longer see or hear steam or coolant escaping, you may open the engine compartment with caution.
- When working in the engine compartment, remember that the radiator fan can switch on even if the ignition is switched off, which increases the risk of injury.
- Coolant additive and coolant can be dangerous to your health. For this reason, store the coolant in the original container and away from children. There is a risk of poisoning.

Note

Coolant loss that results in the coolant expansion tank becoming nearly empty primarily indicates that there are significant leaks in the cooling system, which can lead to further damage.

- Do not add coolant if the expansion tank is empty. Air could enter the cooling system and increase the risk of damage. If this is the case, do not continue driving. See an authorized Audi dealer or authorized Audi Service Facility for assistance.
- If there is any coolant remaining, add additional coolant. Drive to an authorized Audi dealer or authorized Audi Service Facility immediately to have the malfunction corrected. If the  indicator light turns on again, do not continue driving and switch the ignition off. See an authorized Audi dealer or authorized Audi Service Facility for assistance.

- If there is too much coolant in the expansion tank after adding coolant, drive to an authorized Audi dealer or authorized Audi Service Facility as soon as possible to have the coolant level corrected.

Brake fluid



Fig. 168 Engine compartment: cap on brake fluid reservoir

Observe the safety precautions ⇒ *page 253, General information*.

Checking the brake fluid level

- ▶ Park the vehicle on a level surface.
- ▶ Slide the cover that is located below the windshield wipers on the driver's side toward the windshield and remove the cover.
- ▶ Read the brake fluid level on the brake fluid reservoir ⇒ *page 256, fig. 164*. The brake fluid level must be between the MIN and MAX markings ⇒ .

The brake fluid level is monitored automatically.

Messages

The following messages may appear depending on the vehicle equipment:

BRAKE /  Brakes: stop vehicle and check brake fluid level

Stop the vehicle and check the brake fluid level. See an authorized Audi dealer or authorized Audi Service Facility for assistance.

Changing the brake fluid

Brake fluid should be changed at regular intervals. Have the brake fluid changed by an authorized Audi dealer or authorized Audi Service Facility. The authorized Audi dealer or authorized Audi

Service Facility will inform you of the replacement intervals.

 **WARNING**



- If the brake fluid level is below the MIN marking, it can impair the braking effect and driving safety, which increase the risk of an accident. Do not continue driving. See an authorized Audi dealer or authorized Audi Service Facility for assistance.
- If the brake fluid is old, bubbles may form in the brake system during heavy braking. This could impair braking performance and driving safety, which increases the risk of an accident.
- The brake fluid in your vehicle must meet the standard VW 501 14 and is available at an authorized Audi dealer or authorized Audi Service Facility. If this brake fluid is not available, another high-grade brake fluid of equivalent quality may be used, and it must meet the U.S. Federal Motor Vehicle Standard (FMVSS) 116 DOT 4, Class 6.
- Reusing brake fluid or using brake fluid that is not permitted for your vehicle will significantly impair the braking performance and can even lead to a failure of the brake system. The manufacturer of the vehicle is not liable for failures or damage resulting from this. It will also not be covered by the warranty.



 **Note**

- If the brake fluid level is above the MAX marking, brake fluid may leak out over the edge of the reservoir and result in damage to the vehicle.
- Do not allow any brake fluid to come into contact with the vehicle paint, because it will corrode the paint.

Electrical system

The following messages may appear depending on the vehicle equipment:

If the  /  or  indicator light turns on, there is a malfunction in the power supply, the battery, or the vehicle electrical system.

 /  **Electrical system: malfunction! Safely stop vehicle**

Safely stop your vehicle, do not continue driving and switch the ignition off \Rightarrow . See an authorized Audi dealer or authorized Audi Service Facility for assistance.

 **Electrical system: malfunction! Restart not possible. Please contact Service**

If you switch the ignition off, you will not be able to restart the vehicle. Vehicle functions or driving stability may be limited. Drive to an authorized Audi dealer or authorized Audi Service Facility immediately.

 **Electrical system: malfunction! Please contact Service**

Switch off all electrical equipment that is not needed. If necessary, some equipment will be switched off automatically. Vehicle functions or driving stability may be limited. Drive to an authorized Audi dealer or authorized Audi Service Facility immediately.

 **Electrical system: low battery charge. Battery will be charged while driving**

The starting ability may be impaired.

- If this message turns off after a little while, the vehicle battery has charged enough while driving.
- If the message does not turn off, drive immediately to an authorized Audi dealer or authorized Audi Service Facility to have the malfunction repaired.

 **WARNING**

When there is an electrical system malfunction, vehicle functions may not work and driving stability may be limited, which increases the risk of an accident. Do not continue driving and switch the ignition off. See an authorized Audi dealer or authorized Audi Service Facility for assistance.

Battery

Battery general information

Because of the complex power supply, all work on batteries such as disconnecting, replacing, etc., should **only** be performed by an authorized Audi dealer or authorized Audi Service Facility

⇒ .

Multiple batteries with different technologies may be installed in your vehicle:

- Vehicle battery (for example, for starting the engine, basic power supply) ⇒ *page 265, Safety precautions*
- Auxiliary battery (for example, for recuperation or optional equipment) ⇒ *page 265, Safety precautions*

Not running the vehicle for long periods of time

The battery will gradually drain if the vehicle does not run for long periods of time. To ensure that the vehicle can still be started, the electrical equipment will be limited or switched off. Some convenience functions, such as interior lighting or power seat adjustment, may not be available under certain circumstances. The convenience functions will be available again when you start the engine.

Even when electrical equipment is switched off, the equipment can still drain the battery if the vehicle is not driven for long periods of time. Deep draining results in a chemical reaction that destroys the inside of the battery. The battery must be charged every month to prevent this ⇒ *page 266*. Contact an authorized Audi dealer or authorized Audi Service Facility for more information.

Winter operation

Cold weather places an especially high load on the 12 volt vehicle battery. Have the battery checked by an authorized Audi dealer or authorized Audi Service Facility before cold weather begins.

Replacing the battery

Applies to: 12 volt vehicle battery

All work on the battery must **only** be performed by an authorized Audi dealer or authorized Audi Service Facility.

The 12 volt vehicle battery was developed based on the installation location and is equipped with safety features. If a 12 volt vehicle battery must be replaced, ask your authorized Audi dealer or authorized Audi Service Facility about the electro-magnetic compatibility, size, and the necessary maintenance, power, and safety standards for the new 12 volt vehicle battery. The battery vent of the 12 volt vehicle battery must always be on the negative terminal side. The battery vent on the positive terminal side must always be closed.

When replacing the 12 volt lead-acid vehicle battery, only use a maintenance-free 12 volt lead-acid battery that conforms to the TL 825 06 and VW 7 50 73 standards. These standards must be from October 2014 or newer.

WARNING

- All work on the battery or electrical system in your vehicle can result in injuries, chemical burns, accidents, or burns. Because of this, all work must be performed **only** by an authorized Audi dealer or authorized Audi Service Facility.
- Always have an authorized Audi dealer or authorized Audi Service Facility replace the 12 volt vehicle battery, because adaptation must be performed on the vehicle electrical system when the battery is replaced. Only an authorized Audi dealer or authorized Audi Service Facility has the necessary technology to perform the adaptation correctly. Otherwise, there could be a loss of safety-related functions among other things, which increases the risk of an accident.
- Never connect a charging cable or jump start cable directly to the 12 volt vehicle battery. Only use the connections in the engine compartment ⇒ *page 266*.

WARNING

California Proposition 65 Warning: ▶

- Battery posts, terminals and related accessories contain lead and lead compounds, chemicals known to the State of California to cause cancer and reproductive harms. Wash hands after handling.

Note









- If the vehicle will be parked for long periods of time, protect the battery against the cold so that it will not be destroyed by "freezing" ⇒ page 266, *Charging the 12 volt vehicle battery*.
- There are electrical components under the cargo floor behind a trim panel that warm up during operation. To reduce the risk of the components overheating, do not store objects such as blankets under the cargo floor. If the components overheat, they will switch off temporarily. This will be indicated by a message that will be displayed in the instrument cluster until the temperature returns to normal.
- Always have an authorized Audi dealer or authorized Audi Service Facility replace the 12 volt vehicle battery, because an adaptation must be performed on the vehicle electrical system when the battery is replaced. Only an authorized Audi dealer or authorized Audi Service Facility has the necessary technology to perform the adaptation correctly.
- Using unsuitable batteries may void the vehicle's operating license.

For the sake of the environment

 Batteries must be disposed of using methods that will not harm the environment. Do not dispose of them in household trash. They contain harmful substances and recyclable raw materials. Contact an authorized Audi dealer or authorized Audi Service Facility for more information.

Safety precautions

Explanation of warning symbols:

	Observe all warnings - there is a risk for injury!
	Always follow the instructions in the operating manual.
	Electrolyte fluid is highly corrosive. Always wear protective gloves and eye protection. First aid: if electrolyte fluid enters the eyes, immediately flush with clean water for several minutes. Seek medical attention immediately. Immediately neutralize electrolyte fluid on the skin or clothing using a soap solution and rinse with plenty of water. Seek medical attention immediately if electrolyte fluid is ingested.
	Always wear eye protection.
	If electrolyte fluid enters the eyes, immediately flush with clean water for several minutes. Seek medical attention immediately.
	Fire, sparks, open flame, and smoking are prohibited. Avoid creation of sparks and short circuits when handling cables and electrical devices.
	Always keep children away from battery electrolyte fluid and the battery.
	A highly explosive mixture of gases can form when charging batteries.

WARNING

All work on the batteries must **only** be performed by an authorized Audi dealer or authorized Audi Service Facility.

- Gases that escape from these batteries can be poisonous or flammable.
- The contents of these batteries can be corrosive. If any battery contents come into contact with the skin, flush the affected area for at least 15 minutes with clean water. Then wash the affected area with soap. Have the affected area examined by a medical professional.

! Note

Applies to: mild hybrid drive

- Components must not be connected to the battery terminals and wires on the 48 volt battery because this increases the risk of damage, for example due to overvoltage.
- Have maintenance work performed only by trained personnel.
- Have the 48 volt lithium battery replaced only by an authorized Audi dealer or authorized Audi Service Facility. Audi recommends an authorized Audi dealer or authorized Audi Service Facility, because these locations have trained personnel and the required parts and tools.
- Never try to replace the 48 volt lithium battery yourself. The 48 volt lithium battery in this vehicle may only be replaced with a 48 volt lithium battery designed by Audi specifically for this vehicle. Using other 48 volt lithium or lead batteries will result in considerable malfunctions or even total failure of the electrical system.
- Never make modifications to the lithium battery.
- Never open the 48 volt battery.

Charging the 12 volt vehicle battery

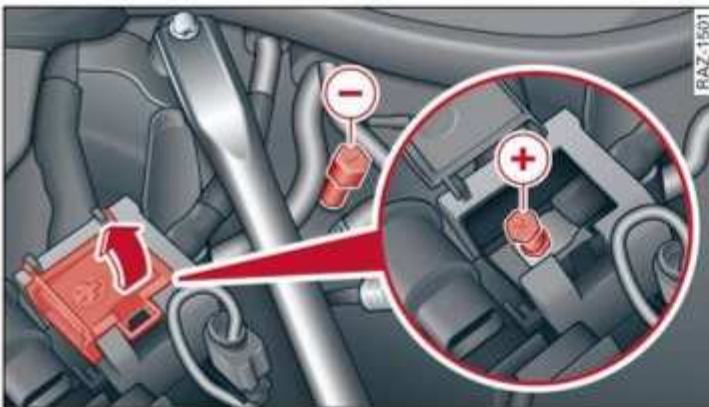

Fig. 169 Engine compartment: connectors for a charger or jump start cables

Observe the safety precautions ⇒ page 253, *General information*, ⇒ ⚠ in *Battery general information* on page 264 and ⇒ ⚠.

Requirement: only use chargers with a **maximum charging current of 14.8 volts**. The battery cables remain connected.

The charging cable connections are located in the engine compartment. The ground point ⊖ is always located on the vehicle body.

- ▶ Switch off the ignition and all electrical equipment.
- ▶ Open the hood ⇒ page 255.
- ▶ Press the release lever on the positive terminal and fold the cover upward ⇒ fig. 169.
- ▶ Clamp the charger terminal clamps to the jump start pins according to the instructions. (Hex head bolt under a cover ⊕, ground point on the vehicle body ⊖).
- ▶ Insert the power cable for the charger into the socket and switch the charger on.
- ▶ At the end of the charging process, switch the charger off and pull the power cable out of the socket.
- ▶ Remove the charger terminal clamps.
- ▶ Close the cover on the positive terminal.
- ▶ Close the hood ⇒ page 255.

⚠ WARNING

- Never use charging equipment that is unsuitable, visibly damaged, and/or dirty. Check the charging equipment for damage before every use.
- Never connect a charging cable or jump start cable directly to the 12 volt vehicle battery. Only use the connections in the engine compartment ⇒ page 266.
- A highly explosive mixture of gases can form when charging batteries. Only charge the battery in well-ventilated areas.
- A drained battery can freeze at temperatures around 32 °F (0 °C). Do not charge or use a frozen or thawed battery. If ice forms, the battery housing can crack and battery electrolyte fluid can leak, which increases the risk of an explosion and chemical burns. Contact an authorized Audi dealer or authorized Audi Service Facility for more information.
- Leave the hood open while the 12 volt vehicle battery is charging. If the hood is closed, it could cause an electrical short circuit, which increases the risk of fire.

i Tips

Read all of the manufacturer's instructions for the charger before charging the battery.

Windshield washer system



Fig. 170 Engine compartment: washer fluid reservoir cap

Observe the safety precautions ⇒ page 253, *General information*.

The windshield washer reservoir  contains the cleaning solution for the windshield and the headlight washer system* ⇒ fig. 170, ⇒ page 256. The reservoir capacity can be found in ⇒ page 323.

To reduce the risk of lime scale deposits on the spray nozzles, use clean water with low amounts of calcium. Always add window cleaner to the water. When the outside temperatures are cold, an anti-freezing agent should be added to the water so that it does not freeze.

Messages

The following messages may appear depending on the vehicle equipment:

Please add washer fluid

Fill the washer fluid for the windshield washer system and the headlight washer system* when the ignition is switched off.

! Note

- The concentration of anti-freezing agent must be adjusted to the vehicle operating conditions and the climate. A concentration that is too high can lead to vehicle damage.

- Never add radiator anti-freeze or other additives to the washer fluid.
- Do not use a glass cleaner that contains paint solvents, because this could damage the paint.

Service interval display

The service interval display detects when your vehicle is due for service.

The service interval display works in two stages:

- **Inspection or oil change reminder:** after driving a certain distance, a message will appear in the instrument cluster display each time the ignition is switched on or off, depending on the vehicle equipment. The remaining distance or time is displayed briefly.
- **Inspection or oil change due:** if your vehicle has reached an inspection or oil change interval or both intervals at the same time, the message **Inspection due!** or **Oil change due!** or **Oil change and inspection due!** appears briefly after switching the ignition on or off.

Checking service intervals

You can check the remaining distance or time until the next oil change or next inspection in the Infotainment system.

Applies to MMI: Select on the home screen: **VEHICLE > Settings & Service > Service intervals**.

Resetting the indicator

An authorized Audi dealer or authorized Audi Service Facility will reset the service interval display after performing service.

If you have changed the oil yourself, you must reset the oil change interval.

Applies to: MMI: To reset the display, select on the home screen: **VEHICLE > Settings & Service > Service intervals**.

! WARNING

Inadequate service, a lack of service, or failing to adhere to the service intervals can result in the vehicle breaking down in traffic, accidents, and serious injuries.

Note

- Only reset the oil change indicator if the oil was changed.
- Regular service work on the vehicle is not only beneficial for the sustainable use and retention of the vehicle value, but also for the operational and traffic safety. For this reason, always have service work performed according to the Audi guidelines.
- Even if the mileage on the vehicle is low, do not exceed the time for the next service.
- Audi is not responsible for damage to the vehicle that occurred due to inadequate service or insufficient part availability.

Wheels

Tires and rims

General information

The combination of a rim and tire will be referred to as a wheel in this Owner's Manual. If only one of the components is referred to, then the term tire or rim will be used.

- ▶ Check your tires regularly for damage, such as punctures, cuts, cracks, and bulges. Remove foreign objects from the tire tread.
- ▶ If driving over curbs or similar obstacles, drive slowly and approach the curb at an angle.
- ▶ Have faulty tires or rims replaced immediately.
- ▶ Protect your tires from oil, grease, and fuel.
- ▶ Mark tires before removing them so that the same running direction can be maintained if they are reinstalled.
- ▶ Lay tires flat when storing and store them in a cool, dry location with as little exposure to light as possible.



WARNING

- Never drive faster than the maximum permitted speed for your tires. This could cause the tires to heat up too much. This increases the risk of an accident because it can cause the tire to burst.
- Always adapt your driving to the road and traffic conditions. Drive carefully and reduce your speed on icy or slippery roads. Even winter tires can lose traction on black ice.



Note

- Please note that summer and winter tires are designed for the conditions that are typical in those seasons. Audi recommends winter tires during the winter months. Low temperatures significantly decrease the elasticity of summer tires, which affects traction and braking ability. If summer tires are used in very cold temperatures, cracks can form on the tread bars, resulting in permanent tire damage that can cause loud driving noise and unbalanced tires.

–Burnished, polished or chromed rims must not be used in winter driving conditions. The surface of the rims does not have sufficient corrosion protection for this and could be permanently damaged by road salt or similar substances. The exception to this are rims that are part of complete winter wheels provided by the factory.

Tire designations

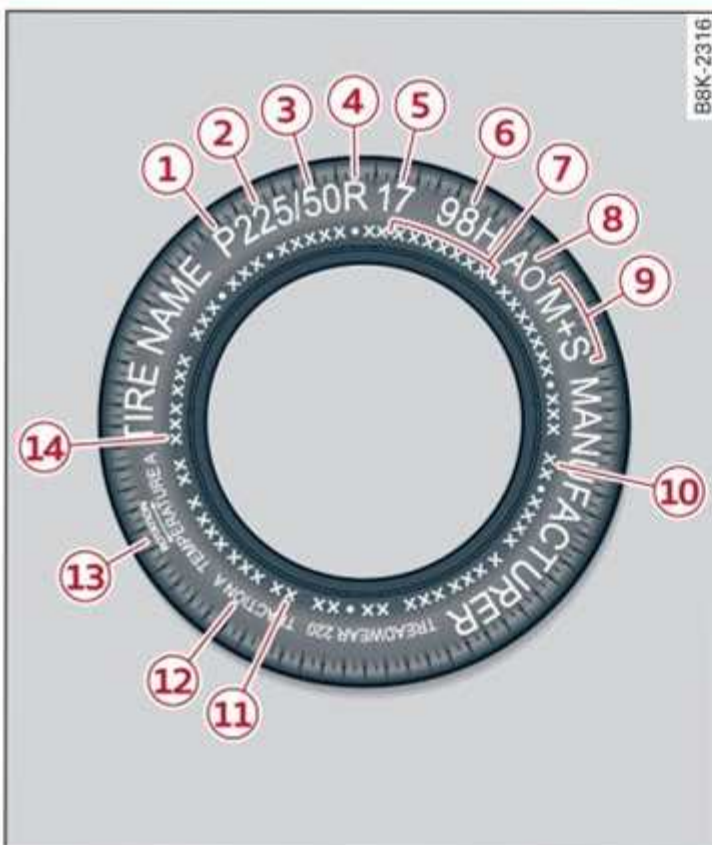

Fig. 171 Tire designations on the sidewall

① Tires for passenger vehicles (if applicable)

“P” indicates a tire for a passenger vehicle. “T” indicates a tire designated for temporary use.

HL indicates High Load Capacity tires.

② Nominal width

Nominal width of the tire between the sidewalls in millimeters. In general: the larger the number, the wider the tire.

③ Aspect ratio

Height/width ratio expressed as a percentage.

④ Tire construction

“R” indicates a radial tire.

⑤ Rim diameter

Size of the rim diameter in inches.

⑥ Load index and speed rating

The load index indicates the tire's load-carrying capacity.

The speed rating indicates the maximum permitted speed. Also see ⇨ **▲** in *General information* on page 269.

“EXTRA LOAD”, “xl” or “RF” indicates that the tire is reinforced or is an Extra Load tire. ▶

Speed rating	Maximum permitted speed
P	up to 93 mph (150 km/h)
Q	up to 99 mph (160 km/h)
R	up to 106 mph (170 km/h)
S	up to 110 mph (180 km/h)
T	up to 118 mph (190 km/h)
U	up to 124 mph (200 km/h)
H	up to 130 mph (210 km/h)
V	up to 149 mph (240 km/h) ^{a)}
Z	above 149 mph (240 km/h) ^{a)}
W	up to 168 mph (270 km/h) ^{a)}
Y	up to 186 mph (300 km/h) ^{a)}

^{a)} For tires above 149 mph (240 km/h), tire manufacturers sometimes use the code “ZR”.

⑦ US DOT number (TIN) and manufacture date

The manufacture date is listed on the tire sidewall (it may only appear on the inner side of the tire):

DOT ... 2223 ...

means, for example, that the tire was produced in the 22nd week of the year 2023.

⑧ AO or RO

Tires with the designation “AO” or “RO” that have been specifically matched to your Audi are installed at the factory. When used correctly, these tires meet very high standards for safety and handling. An authorized Audi dealer or authorized Audi Service Facility

will be able to provide you with more information.

⑨ Mud and snow capability

“M/S” or “M+S” indicates the tire is suitable for driving on mud and snow.  indicates a winter tire.

⑩ Composition of the tire cord and materials

The number of plies indicates the number of rubberized fabric layers in the tire. In general: the more layers, the more weight a tire can carry. Tire manufacturers must also specify the materials used in the tire. These include steel, nylon, polyester and other materials.

⑪ Maximum permitted load

This number indicates the maximum load in kilograms and pounds that the tire can carry.

⑫ Uniform tire quality grade standards for treadwear, traction and temperature resistance

Treadwear, traction, and temperature ranges ⇨ *page 286*.

⑬ Running direction

The arrows indicate the running direction of unidirectional tires. ▶

You must always follow the specified running direction
⇒ *page 303*.

14 Maximum permitted inflation pressure

This number indicates the maximum pressure to which a tire can be inflated under normal operating conditions.

Glossary of tire and loading terminology

Accessory weight

means the combined weight (in excess of those standard items which may be replaced) of automatic transmission, power steering, power brakes, power windows, power seats, radio, and heater, to the extent that these items are available as factory-installed equipment (whether installed or not).

Aspect ratio

means the ratio of the height to the width of the tire in percent. Numbers of 55 or lower indicate a low sidewall for improved steering response and better overall handling on dry pavement.

Bead

means the part of the tire that is made of steel wires, wrapped or reinforced by ply cords and that is shaped to fit the rim.

Bead separation

means a breakdown of the bond between components in the bead.

Cord

means the strands forming the plies in the tire.

Cold tire inflation pressure

means the tire pressure recommended by the vehicle manufacturer for a tire of a designated size that has not been driven for more than a couple of miles (kilometers) at low speeds in the three hour period before the tire pressure is measured or adjusted.

Curb weight

means the weight of a motor vehicle with standard equipment including the maximum capacity of fuel, oil, and coolant, air conditioning and additional weight of optional equipment.

Extra load tire

means a tire designed to operate at higher loads and at higher

inflation pressures than the corresponding standard tire. Extra load tires may be identified as “XL”, “xl”, “EXTRA LOAD”, or “RF” on the sidewall.

Gross Axle Weight Rating (“GAWR”)

means the load-carrying capacity of a single axle system, measured at the tire-ground interfaces.

Gross Vehicle Weight Rating (“GVWR”)

means the maximum total loaded weight of the vehicle.

Groove

means the space between two adjacent tread ribs.

High load capacity tire

High load capacity tires are extra load tires that are designed to carry a higher load at the same pressure. High load capacity tires are identified with the prefix “HL” in front of the tire size designation.

Load rating (code)

means the maximum load that a tire is rated to carry for a given inflation pressure. You may not find

this information on all tires because it is not required by law.

Maximum load rating

means the load rating for a tire at the maximum permissible inflation pressure for that tire.

Maximum loaded vehicle weight

means the sum of:

- (a) Curb weight
- (b) Accessory weight
- (c) Vehicle capacity weight, and
- (d) Production options weight

Maximum (permissible) inflation pressure

means the maximum cold inflation pressure to which a tire may be inflated. Also called “maximum inflation pressure.”

Normal occupant weight

means 150 lbs. (68 kilograms) times the number of occupants seated in the vehicle up to the total seating capacity of your vehicle.

Occupant distribution

means distribution of occupants in a vehicle. ▶

Outer diameter

means the overall diameter of an inflated new tire.

Overall width

means the linear distance between the exteriors of the sidewalls of an inflated tire, including elevations due to labeling, decorations, or protective bands or ribs.

Ply

means a layer of rubber-coated parallel cords.

Production options weight

means the combined weight of those installed regular production options weighing over 5 lbs.

(2.3 kg) in excess of those standard items which they replace, not previously considered in curb weight or accessory weight, including heavy duty brakes, ride levelers, roof rack, heavy duty battery, and special trim.

Radial ply tire

means a pneumatic tire in which the ply cords that extend to the beads are laid at substantially 90 degrees to the centerline of the tread.

Recommended inflation pressure

see ⇒ *page 272, Cold tire inflation pressure.*

Reinforced tire

means a tire designed to operate at higher loads and at higher inflation pressures than the corresponding standard tire. Reinforced tires may be identified as “XL”, “xl”, “EXTRA LOAD”, or “RF” on the sidewall.

Rim

means a metal support for a tire or a tire and tube assembly upon which the tire beads are seated.

Rim diameter

means nominal diameter of the bead seat. If you change your wheel size, you will have to purchase new tires to match the new rim diameter.

Rim size designation

means rim diameter and width.

Rim width

means nominal distance between rim flanges. ▶

Sidewall

means that portion of a tire between the tread and bead.

Speed rating (letter code)

means the speed at which a tire is designed to be driven for extended periods of time. The ratings range from 93 mph (150 km/h) to 186 mph (298 km/h) ⇒ *table on page 271*. You may not find this information on all tires because it is not required by law.

The speed rating letter code, where applicable, is molded on the tire sidewall and indicates the maximum permissible road speeds. See also ⇒  *in General information on page 269*.

Tire pressure monitoring system

means a system that detects when one or more of a vehicle's tires are underinflated and illuminates a low tire pressure warning telltale.

Tread

means that portion of a tire that comes into contact with the road.

Tread separation

means pulling away of the tread from the tire carcass.

Treadwear indicators (TWI)

means the projections within the principal grooves designed to give a visual indication of the degrees of wear of the tread. See ⇒ *page 279, Treadwear indicator* for more information on measuring tire wear.

Uniform Tire Quality Grading

is a tire information system developed by the United States National Highway Traffic Safety Administration (NHTSA) that is designed to help buyers make relative comparisons among tires. The UTQG is not a safety rating and not a guarantee that a tire will last for a prescribed number of miles (kilometers) or perform in a certain way. It simply gives tire buyers additional information to combine with other considerations, such as price, brand loyalty and dealer recommendations. Under UTQG, tires are graded by the tire manufacturers in three areas: ►

treadwear, traction, and temperature resistance. The UTQG information on the tires, molded into the sidewalls.

U.S. DOT Tire Identification Number (TIN)

This is the tire's "serial number". It begins with the letters "DOT" and indicates that the tire meets all federal standards. The next two numbers or letters indicate the plant where it was manufactured, and the last four numbers represent the week and year of manufacture. For example,

DOT ... 2223 ...

means that the tire was produced in the 22nd week of 2023. The other numbers are marketing codes that may or may not be used by the tire manufacturer. This information is used to contact consumers if a tire defect requires a recall.

Vehicle capacity weight

means the rated cargo and luggage load plus 150 lbs. (68 kilograms) times the vehicle's designated seating capacity.

Vehicle maximum load on the tire

means that load on an individual tire that is determined by distributing to each axle its share of the maximum loaded vehicle weight and dividing by two.

Vehicle normal load on the tire

means that load on an individual tire that is determined by distributing to each axle its share of the curb weight, accessory weight, and normal occupant weight (distributed in accordance with \Rightarrow *table on page 281*) and dividing by two.

Occupant loading and distribution for vehicle normal load for various designated seating capacities

Refer to the tire inflation pressure label \Rightarrow *page 280, fig. 174* for the number of seating positions. Refer to the table \Rightarrow *table on page 281* for the number of people that correspond to the vehicle normal load.

New tires or wheels

Audi recommends having all work on tires or wheels performed by an authorized Audi dealer or ▶

authorized Audi Service Facility. These facilities have the proper knowledge and are equipped with the required tools and replacement parts.

- ▶ New tires do not yet have the optimal gripping properties. Drive carefully and at moderate speeds for the first 350 miles (500 km) with new tires.
- ▶ Only use tires with the same design, size (rolling circumference), and as close to the same tread pattern as possible on all four wheels.
- ▶ Do not replace tires individually. At least replace both tires on the same axle at the same time.
- ▶ Audi recommends using Audi Genuine Tires. If you would like to use different tires, please note that the tires may perform differently even if they are the same size ⇒ ⚠.
- ▶ If you would like to equip your vehicle with a tire and rim combination that is different from what was installed at the factory, consult with an authorized Audi dealer or authorized Audi Service Facility before making a purchase ⇒ ⚠.

Because the spare tire* is different from the regular tires installed on the vehicle (such as winter tires or wide tires), only use the spare tire* temporarily in case of emergency and drive carefully while it is in use. It should be replaced with a regular tire as soon as possible.

All four wheels must be equipped with tires that are the same brand and have the same construction and tread pattern so that the drive system is not damaged by different tire speeds. For this reason, in case of emergency, only use a spare tire* that is the same circumference as the regular tires.

WARNING

- Do not use steel rims that are 17 inches or larger. Otherwise, damage to the vehicle and an accident could result.
- Only use tire/rim combinations and suitable wheel bolts that have been approved by Audi. Otherwise, damage to the vehicle and an accident could result.
- For technical reasons, it is not possible to use tires from

other vehicles. In some cases, you cannot even use tires from the same vehicle model.

- Make sure that the tires you select have enough clearance to the vehicle. Replacement tires should not be chosen simply based on the nominal size, because tires with a different construction can differ greatly even if they are the same size. If there is not enough clearance, the tires or the vehicle can be damaged and this can reduce driving safety and increase the risk of an accident.
- Only use tires that are more than six years old when absolutely necessary and drive carefully when doing so.
- Do not use run-flat tires on your vehicle. Using them when not permitted can lead to vehicle damage or accidents.
- If you install wheel covers on the vehicle, make sure they allow enough air circulation to cool the brake system. If they do not, this could increase the risk of an accident.
- Mounting a tire on the rim incorrectly can result in tire

damage or failure. To reduce the risk of an accident, only trained personnel may mount a tire on the rim.

Tire wear and damage



Fig. 172 Tire profile: treadwear indicator

Tire wear

Check the tires regularly for wear.

- Inflation pressure that is too low or high can increase tire wear considerably.
- Driving quickly through curves, rapid acceleration, and heavy braking increase tire wear. When driving under these conditions, check the tread depth every 3,100 miles (5,000 km) to 6,200 miles (10,000 km).
- Have an authorized Audi dealer or authorized Audi Service Facility check the wheel alignment if there is unusual wear.
- Have the wheels rebalanced if an imbalance is causing noticeable ►

vibration in the steering wheel. If you do not, the tires and other vehicle components could wear more quickly.

Treadwear indicator

Original equipment tires contain treadwear indicators in the tread pattern, which are bars that are 1/16 inch (1.6 mm) high and are spaced evenly around the tire perpendicular to the running direction ⇒ *fig. 172*. The letters “TWI” or triangles on the tire sidewall indicate the location of the treadwear indicators.

When checking tread depth, you must check the wear indicators across the entire width of the tire and on all four tires.

The tires have reached the minimum tread depth ¹⁾ when they have worn down to the treadwear indicators. Replace the tires with new ones ⇒ .

Tire rotation

Rotating the tires regularly is recommended to ensure the tires wear evenly. To rotate the tires,

install the tires from the rear axle on the front axle and vice versa. This will allow the tires to have approximately the same length of service life.

For unidirectional tires, make sure the tires are installed according to the running direction indicated on the tire sidewall

⇒ *page 303*.

Hidden damage

Damage to tires and rims can often occur in locations that are hidden. Unusual vibrations in the vehicle or pulling to one side may indicate that there is tire damage. Reduce your speed immediately. Check the tires for damage. If no damage is visible from the outside, drive slowly and carefully to the nearest authorized Audi dealer or authorized Audi Service Facility to have the vehicle inspected.



WARNING

Tread that has worn too low or uneven tread depths on the tires can reduce driving safety. ▶

¹⁾ Obey any applicable regulations in the country where the vehicle is being operated.

This can increase the risk of an accident because it has a negative effect on handling, driving through curves, and braking, and because it increases the risk of hydroplaning when driving through deep puddles.

Tire pressure



Fig. 173 Driver's side B-pillar: tire pressure label

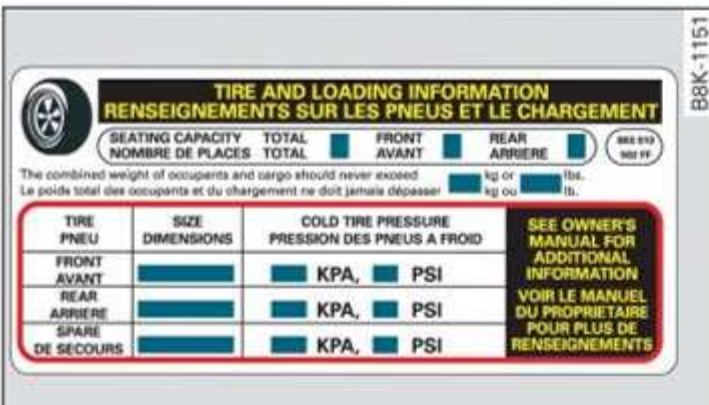

Fig. 174 Tire pressure label

The correct tire pressure for tires installed at the factory is listed on a label. The label is located on the B-pillar ⇒ *fig. 173*, ⇒ *fig. 174*.

Use the tire pressure specified for a normal vehicle load when the vehicle is partially loaded ⇒ *table*

on page 281. If driving the vehicle when fully loaded, you must increase the tire pressure to the maximum specified pressure

⇒ ⚠.

Checking and correcting tire pressure

- ▶ Check the tire pressure at least once per month and also check it before every long drive.
- ▶ Always check the tire pressure when the tires are *cold*. Do not reduce the pressure if it increases when the tires are warm.
- ▶ Refer to the sticker ⇒ *fig. 174* for the correct tire pressure.
- ▶ Correct the tire pressure if necessary.
- ▶ Store the new tire pressure in the MMI ⇒ *page 289* or ⇒ *page 291*.
- ▶ Check the pressure in the spare tire*. Always maintain the maximum temperature that is specified for the tire.



WARNING

Always adapt the tire pressure to your driving style and the vehicle load.

–Overloading can lead to loss of vehicle control and increase the risk of an accident. Read

and follow the important safety precautions in ⇒ *page 282*.

–The tire must flex more if the tire pressure is too low or if the vehicle speed or load are too high. This heats the tire up too much. This increases the risk of an accident because it can cause the tire to burst and result in loss of vehicle control.

–Incorrect tire pressure increases tire wear and has a negative

effect on driving and braking behavior, which increases the risk of an accident.



Note

Replace lost valve caps to reduce the risk of damage to the tire valves.



For the sake of the environment

Tire pressure that is too low increases fuel consumption.

Tire pressure table

Please note that the information contained in the following table was correct at the time of printing, and the information is subject to change. If there are any differences, you should always follow the tire pressure sticker ⇒ *page 280, fig. 173*.

Make sure that the tire designation on your tire matches the designation on the tire pressure label and the tire pressure table.

The following table lists recommended tire pressures in cold tires according to the load and the size of the tires installed.

Model/ Engine	Tire designation	Tire pressure							
		Normal load (up to 2*/3 people) ^{a)}				Maximum load			
		Front		Rear		Front		Rear	
		kPa	PSI	kPa	PSI	kPa	PSI	kPa	PSI
A8 L: 3.0L 6-cylinder	255/45 R19 104Y	240	35	220	32	240	35	240	35
	265/40 R20 104Y	240	35	220	32	240	35	240	35
	255/45 R19 104H	250	36	230	33	260	38	260	38
	265/40 R20 104H	250	36	230	33	260	38	260	38
	265/35 R21 101H	270	39	250	36	280	41	280	41
	265/35 R21 101Y	250	36	230	33	260	38	260	38

Model/ Engine	Tire designation	Tire pressure							
		Normal load (up to 2*/3 people) ^{a)}				Maximum load			
		Front		Rear		Front		Rear	
		kPa	PSI	kPa	PSI	kPa	PSI	kPa	PSI
S8 L: 4.0L 8-cylinder	265/40 R20 104Y	280	41	250	36	300	44	280	41
	265/35 R21 101H	300	44	260	38	320	46	300	44
	265/35 R21 101Y	310	45	270	39	320	46	320	46

a) **Vehicles with four seating positions:** two people in the front, **Vehicles with five seating positions:** two people in the front, one person in the rear



WARNING

Please note the important safety precautions regarding tire pressure ⇒ *page 280* and load limits ⇒ *page 282*.

Tires and vehicle load limits

There are limits to the amount of load or weight that any vehicle and any tire can carry. A vehicle that is overloaded will not handle well and is more difficult to stop. Overloading can not only lead to loss of vehicle control, but can also damage important parts of the vehicle and can lead to sudden tire failure, including a blowout and sudden deflation that can cause the vehicle to crash.

Your safety and that of your passengers also depends on making sure that load limits are not exceeded. Vehicle load includes ev-

erybody and everything in and on the vehicle. These load limits are technically referred to as the vehicle's **Gross Vehicle Weight Rating** ("GVWR").

The "GVWR" includes the weight of the basic vehicle, all factory installed accessories, a full tank of fuel, oil, coolant and other fluids plus maximum load. The maximum load includes the number of passengers that the vehicle is intended to carry ("seating capacity") with an assumed weight of 150 lbs. (68 kg) for each passenger at a designated seating position and the total weight of any luggage in the vehicle. If you tow a trailer, the weight of the trailer hitch and the tongue weight of the loaded trailer must be included as part of the vehicle load.

The **Gross Axle Weight Rating** ("GAWR") is the maximum load ►

that can be applied at each of the vehicle's two axles.

The fact that there is an upper limit to your vehicle's Gross Vehicle Weight Rating means that the total weight of whatever is being carried in the vehicle (including the weight of a trailer hitch and the tongue weight of the loaded trailer) is limited. The more passengers in the vehicle or passengers who are heavier than the standard weights assumed mean that less weight can be carried as luggage.

The Gross Vehicle Weight Rating and the Gross Axle Weight Rating are listed on the safety compliance sticker label located on the driver's side B-pillar.



WARNING

Overloading a vehicle can cause loss of vehicle control, a crash or other accident, serious personal injury, and even death.

–Carrying more weight than your vehicle was designed to carry will prevent the vehicle from handling properly and increase the risk of the loss of vehicle control.

- The brakes on a vehicle that has been overloaded may not be able to stop the vehicle within a safe distance.
- Tires on a vehicle that has been overloaded can fail suddenly, including a blowout and sudden deflation, causing loss of control and a crash.
- Always make sure that the total load being transported – including the weight of a trailer hitch and the tongue weight of a loaded trailer – does not make the vehicle heavier than the vehicle's Gross Vehicle Weight Rating.

Determining correct load limit

Use the example below to calculate the total weight of the passengers and luggage or other things that you plan to transport so that you can make sure that your vehicle will not be overloaded.

Steps for Determining Correct Load Limit

1. Locate the statement "THE COMBINED WEIGHT OF OCCUPANTS AND CARGO SHOULD ►

NEVER EXCEED XXX KG OR XXX LBS” on your vehicle’s placard (tire inflation pressure label)
⇒ *page 280, fig. 174.*

2. Determine the combined weight of the driver and passengers that will be riding in your vehicle.
3. Subtract the combined weight of the driver and passengers from “XXX” kilograms or “XXX” pounds shown on the sticker
⇒ *page 280, fig. 174.*
4. The resulting figure equals the available amount of cargo and luggage load capacity. For example, if the “XXX” amount equals 1400 lbs. and there will be five 150 lbs. passengers in your vehicle, the amount of available cargo and luggage load capacity is 650 lbs. (1400-750 (5 x 150) = 650 lbs.)
5. Determine the combined weight of luggage and cargo being loaded on the vehicle. That weight may not safely exceed the available cargo and luggage load capacity calculated in Step 4.
6. If your vehicle will be towing a trailer, load from your trailer

will be transferred to your vehicle. Consult this manual to determine how this reduces the available cargo and luggage load capacity of your vehicle.

- ▶ Check the tire sidewall (⇒ *page 270, fig. 171*) to determine the designated load rating for a specific tire.

Wheel bolts and rims

Wheel bolts

Wheel bolts must be clean and loosen/tighten easily.

Rims

Rims with a bolted rim ring* or with bolted wheel covers* consist of multiple pieces. These components were bolted together using special bolts and a special procedure. You must not repair or disassemble them ⇒ .

WARNING

Wheel bolts that are tightened or repaired incorrectly can become loose and result in loss of vehicle control, which increases the risk of an accident. For the correct tightening specification, see ⇒ *page 304, Finishing.*

- Always keep the wheel bolts and the threads in the wheel hub clean and free of grease.
- Only use wheel bolts that fit the rim.
- Always have damaged rims repaired by an authorized Audi dealer or authorized Audi Service Facility. Never repair or disassemble rims yourself, because this increases the risk of an accident.

Loose wheel warning

Applies to: vehicles with loose wheel warning

Within the limits of the system, the loose wheel warning in the instrument cluster warns you if one or more wheels are loose.

Using the ABS sensors, the loose wheel warning system compares the vibration characteristics of the individual tires. If one or more wheels are loose, it will be indicated in the instrument cluster display with the  indicator light and a message. If only one wheel is affected, the location of that wheel will be indicated.

Messages

 **Wheel bolts loose. Please safely stop the vehicle and check all wheel bolts!**

Loose wheel warning for at least one wheel ⇒ . Check the wheel bolts on all wheels with the wheel wrench (vehicle tool kit). Have the tightening specification checked as soon as possible with a torque wrench. Drive carefully until then. For the correct tightening specification, see ⇒ *page 304, Finishing*.

 **Wheel assessment active. Please continue driving carefully**

After this message appears and you have checked the wheel bolts, the assessment phase begins when the vehicle is in motion. This may take several minutes.

 **Loose wheel warning: malfunction! See owner's manual**

There is a system malfunction. Drive immediately to an authorized Audi dealer or authorized Audi Service Facility to have the malfunction repaired.

WARNING

Wheel bolts that are tightened incorrectly can become loose and result in loss of vehicle control, which increases the risk of an accident.

- If a message appears, reduce your speed immediately and avoid any hard steering or braking maneuvers. Stop as soon as possible and check the wheel bolts.
- Check your wheels for damage. Have the damaged wheels checked and/or replaced

immediately by an authorized Audi dealer or authorized Audi Service Facility.

- Under certain conditions (such as a sporty driving style, winter conditions, or unpaved roads), the message may be delayed.
- The driver is responsible for ensuring that the wheels are secured correctly.

Tips

- The loose wheel warning system can also stop working when there is an ESC malfunction.
- Using snow chains may result in a system malfunction.

Winter tires

Winter tires significantly improve the vehicle's handling when driving in winter conditions. Because of their construction (width, compound, tread pattern), summer tires provide less traction on ice and snow.

- ▶ Use winter tires on all four wheels.
- ▶ Only use winter tires that are approved for your vehicle.
- ▶ Please note that the maximum permitted speed may be lower with winter tires ⇒  in *General information on page 269*. An authorized Audi dealer or authorized Audi Service Facility can inform you about the maximum permitted speed for your tires.
- ▶ Check the tire pressure after installing wheels ⇒ *page 280*.

The effectiveness of winter tires is reduced greatly when the tread is worn down to a depth of 0.16 in (4 mm). The characteristics of winter tires also decrease greatly as the tire ages, regardless of the remaining tread.

For the sake of the environment

Reinstall summer tires at the appropriate time, because they provide better handling when roads are free of snow and ice. Summer tires cause less road noise, tire wear, and fuel consumption. ▶

Tips

You can also use all season tires instead of winter tires. Please note that in some countries where winter tires are required, only winter tires with the  symbol may be permitted.

Snow chains

Snow chains improve both driving and braking in winter road conditions.

- ▶ Only install snow chains on the front wheels.
- ▶ Check and correct the seating of the snow chains after driving a few feet, if necessary. Follow the instructions from the manufacturer.
- ▶ Note the maximum speed of 30 mph (50 km/h). Observe the local regulations.

Use of snow chains is only permitted with certain rim/tire combinations due to technical reasons. Check with an authorized Audi dealer or authorized Audi Service Facility to see if you may use snow chains.

Use **fine-mesh snow chains**. They must not add more than 0.40 inch (10.5 mm) in height, including the chain lock.

You must remove the snow chains on roads without snow. Otherwise, you could impair driving ability and damage the tires.

WARNING

Using incorrect snow chains or installing snow chains incorrectly can result in loss of vehicle control, which increases the risk of an accident.

Note

- Snow chains can damage the rims and wheel covers* if the chains come into direct contact with them. Remove the wheel covers* first. Use coated snow chains.
- Do not install and use snow chains if there is a malfunction in the air suspension, because the vehicle height will be very low. If you drive with snow chains anyway, the wheel

housings and other vehicle components can be severely damaged.

Tips

When using snow chains, it may be advisable to limit the ESC ⇨ *page 123*.

Low-profile tires

Applies to: vehicles with low-profile tires

Compared to other tire/rim combinations, low-profile tires offer a wider tread surface and a larger rim diameter with shorter tire sidewalls. This results in an agile driving style. However, it may reduce the level of comfort and increase road noise when driving on roads in poor condition.

Low-profile tires can become damaged more quickly than standard tires when driving over large bumps, potholes, manhole covers, and curbs. Therefore, it is particularly important to maintain the correct tire pressure ⇨ *page 280*.

To reduce the risk of damage to the tires and rims, drive very carefully on poor roads.

Check your wheels regularly every 2,000 miles (3,000 km) for damage. For example, check for bulges/cracks on the tires or deformations/cracks on the rims.

After a heavy impact or damage, have the tires and rims inspected or replaced immediately by an authorized Audi dealer or authorized Audi Service Facility.

Low-profile tires can wear out faster than standard tires.

Uniform tire quality grading

- Tread wear
- Traction AA A B C
- Temperature A B C

Quality grades can be found where applicable on the tire side wall between tread shoulder and maximum section width ⇨ *page 270, fig. 171*.

For example: Tread wear **200**, Traction **AA**, Temperature **A**.

All passenger car tires must conform to Federal Safety Requirements in addition to these grades.

Tread wear

The *tread wear* grade is a comparative rating based on the wear rate of the tire when tested under controlled conditions on a specified government test course.

For example, a tire graded 150 would wear one and one half (1 1/2) times as well on the government course as a tire graded 100.

The relative performance of tires depends upon the actual conditions of their use, however, and may depart significantly from the norm due to variations in driving habits, service practices and differences in road characteristics and climate.

Traction

The *traction* grades, from highest to lowest, are AA, A, B and C. Those grades represent the tire's ability to stop on wet pavement as measured under controlled conditions on specified government test surfaces of asphalt and concrete. A tire marked C may have poor traction performance ⇒ ⚠.

Temperature

The *temperature* grades are A (the highest), B, and C, representing the tire's resistance to the generation of heat and its ability to dissipate heat when tested under controlled conditions on a specified indoor laboratory test wheel.

Sustained high temperature can cause the material of the tire to degenerate and reduce tire life, and excessive temperature can lead to sudden tire failure ⇒ ⚠.

The grade C corresponds to a level of performance which all passenger car tires must meet under the Federal Motor Vehicle Safety Standard No. 109. Grades B and A represent higher levels of performance on the laboratory test wheel than the minimum required by law.

WARNING

The traction grade assigned to this tire is based on straight-ahead braking traction tests, and does not include acceleration, cornering, hydroplaning or peak traction characteristics.

WARNING

The temperature grade for this tire is established for a tire that is properly inflated and not overloaded. Excessive speed, underinflation, or excessive loading, either separately or in combination, can cause heat buildup and possible tire failure.

WARNING

Temperature grades apply to tires that are properly inflated and not over or underinflated.

Tire pressure monitoring system¹⁾

General notes

Each tire, including the spare (if provided), should be checked monthly when cold and inflated to the inflation pressure recommended by the vehicle manufacturer on the vehicle placard or tire inflation pressure label. (If your vehicle has tires of a different size than the size indicated on the vehicle placard or tire inflation pressure label, you should determine the proper tire inflation pressure for those tires).

As an added safety feature, your vehicle has been equipped with a tire pressure monitoring system (TPMS) that illuminates a low tire pressure telltale when one or more of your tires is significantly under-inflated. Accordingly, when the low tire pressure telltale illuminates, you should stop and check your tires as soon as possible, and inflate them to the proper pressure. Driving on a significantly under-inflated tire causes the tire to overheat and can lead to tire failure. Under-inflation also reduces fuel efficiency and tire tread life, ►

¹⁾ Not available in all countries

and may affect the vehicle's handling and stopping ability.

Please note that the TPMS is not a substitute for proper tire maintenance, and it is the driver's responsibility to maintain correct tire pressure, even if under-inflation has not reached the level to trigger illumination of the TPMS low tire pressure telltale.

Your vehicle has also been equipped with a TPMS malfunction indicator to indicate when the system is not operating properly. The TPMS malfunction indicator is combined with the low tire pressure telltale. When the system detects a malfunction, the telltale will flash for approximately one minute and then remain continuously illuminated. This sequence will continue upon subsequent vehicle start-ups as long as the malfunction exists.

When the malfunction indicator is illuminated, the system may not be able to detect or signal low tire pressure as intended. TPMS malfunctions may occur for a variety of reasons, including the installation of replacement or alternate tires or wheels on the vehicle that prevent the TPMS from functioning properly. Always check the TPMS malfunction telltale after replacing one or more tires or wheels on your vehicle to ensure that the replacement or alternate tires and wheels allow the TPMS to continue to function properly.

If the tire pressure monitoring indicator appears

Applies to: vehicles with Tire Pressure Monitoring System indicator

The tire pressure indicator in the instrument cluster informs you if the tire pressure is too low or if there is a system malfunction.



Using the ABS sensors, the tire pressure monitoring system compares the tire tread circumference and vibration characteristics of the individual tires. If the pressure changes in one or more tires, this is indicated in the instrument cluster display with an indicator light  and a message. If only one tire is affected, the location of that tire will be indicated.

The tire pressures must be stored again each time you change the pressures (switching between partial and full load pressure) or after changing or replacing a tire on your vehicle ⇒ *page 289*. The tire pressure monitoring system only monitors the tire pressure you have stored. Refer to the tire pressure label for the recommended tire pressure for your vehicle ⇒ *page 280, fig. 174*.

Tire tread circumference and vibration characteristics can change and cause a tire pressure warning if:

- The tire pressure in one or more tires is too low
- The tires have structural damage
- The tire was replaced or the tire pressure was changed and it was not stored ⇒ *page 289*
- Tires that are only partially used are replaced with new tires

Indicator lights

If the  indicator light turns on, there is a loss of pressure in at least one tire. ⇒  Check the tires and replace if necessary. Check and correct the pressures of all four tires and store the pressure again ⇒ *page 289*.

If you have not stored new tire pressures, but the indicator light  is blinking and an audio signal sounds, then drive to an authorized Audi dealer or authorized Audi Service Facility immediately to have the malfunction corrected.

TPMS Tire pressure: malfunction! See owner's manual

If **TPMS** appears after switching the ignition on or while driving and the  indicator light in the instrument cluster blinks for approximately one minute and then stays on, there is system malfunction. Try to store the correct tire pressures ⇒ *page 289*. In some cases, you must drive for several minutes after storing the pressures until the indicator light turns off. If the indicator light does turn off or turns on again after a short period of time, drive to an authorized Audi dealer or authorized Audi Service Facility immediately to have the malfunction corrected. ►

⚠ WARNING

- If the tire pressure indicator appears in the display, reduce your speed immediately and avoid any hard steering or braking maneuvers. Stop as soon as possible and check the tires and their pressure.
- The driver is responsible for maintaining the correct tire pressure. You must check the tire pressure regularly.
- Under certain conditions (such as a sporty driving style, winter conditions, or unpaved roads), the tire pressure monitoring system indicator may be delayed.

i Tips

- The tire pressure monitoring system can also stop working when there is an ESC malfunction.
- Using snow chains may result in a system malfunction.
- The tire pressure monitoring system in your Audi was calibrated with “Audi Original Tires” ⇒ *page 276*. Audi recommends using these tires.

Storing tire pressures

Applies to: vehicles with Tire Pressure Monitoring System indicator

If the tire pressure changes or a tire is replaced, it must be confirmed in the MMI.

- ▶ Before storing the tire pressures, make sure the tire pressures of all four tires meet the specified values and are adapted to the load ⇒ *page 280*.
- ▶ Switch the ignition on.
- ▶ Applies to MMI: Select on the home screen: **VEHICLE > Settings & Service > Tire pressure monitoring > Store tire pressure > Yes, store now.**

i Tips

Do not store the tire pressures if snow chains are installed.

Tire pressure monitoring system**(i) General notes**

Each tire, including the spare (if provided), should be checked monthly when cold and inflated to the inflation pressure recommended by the vehicle manufacturer on the vehicle placard or tire inflation pressure label. (If your vehicle has tires of a different size than the size indicated on the vehicle placard or tire inflation pressure label, you should determine the proper tire inflation pressure for those tires).

As an added safety feature, your vehicle has been equipped with a tire pressure monitoring system (TPMS) that illuminates a low tire pressure telltale when one or more of your tires is significantly under-inflated. Accordingly, when the low tire pressure telltale illuminates, you should stop and check your tires as soon as possible, and inflate them to the proper pressure. Driving on a significantly under-inflated tire causes the tire to overheat and can lead to tire failure. Under-inflation also reduces fuel efficiency and tire tread life, and may affect the vehicle's handling and stopping ability.

Please note that the TPMS is not a substitute for proper tire maintenance, and it is the driver's responsibility to maintain correct tire pressure, even if under-inflation has not reached the level to trigger illumination of the TPMS low tire pressure telltale.

Your vehicle has also been equipped with a TPMS malfunction indicator to indicate when the system is not operating properly. The TPMS malfunction indicator is combined with the low tire pressure telltale. When the system detects a malfunction, the telltale will flash for approximately one minute and then remain continuously illuminated. This sequence will continue upon subsequent vehicle start-ups as long as the malfunction exists.

When the malfunction indicator is illuminated, the system may not be able to detect or signal low tire pressure as intended. TPMS malfunctions may occur for a variety of reasons, including the ▶

installation of replacement or alternate tires or wheels on the vehicle that prevent the TPMS from functioning properly. Always check the TPMS malfunction telltale after replacing one or more tires or wheels on your vehicle to ensure that the replacement or alternate tires and wheels allow the TPMS to continue to function properly.

General information

Applies to: vehicles with tire pressure monitoring system

The tire pressure monitoring system monitors the pressure in the four tires when driving.

The system uses sensors that measure the temperature and pressure in the tires. The data is sent from these sensors to the control module by radio frequency.

The tire pressure monitoring system shows the current pressures and temperatures of the tires in the MMI while driving ⇒ *page 290*. It also compares the current tire pressures with the stored tire pressures and gives a warning in the driver information system if the tire pressure is different from what is stored ⇒ *page 291*.

The system does not detect if the stored tire pressures match the recommended tire pressures. You must store the tire pressures again in each of the following situations ⇒ *page 291*:

- Each time the tire pressures change, for example when the load in the vehicle changes
- After replacing a tire
- If wheels with new wheel sensors are used

WARNING

- The tire pressure monitoring system assists with monitoring tire pressures. The driver is always responsible for maintaining the correct tire pressure.
- Do not change the tire pressure when the temperature of the tire is extremely high. This could result in serious damage to the tire and even cause the tire to burst, increasing the risk of an accident.
- A tire with low pressure flexes more. This heats the tire up too much. This could cause

- the tread to separate and even cause the tire to burst, increasing the risk of an accident.
- The tire pressure monitoring system does not warn about damage or defects in the tire construction that could cause the tire to burst, for example. Inspect your tires regularly.

Tips

- If tires are replaced, the sensors and valves do not need to be removed or replaced. Only replace the valve stem and, if necessary, the valve and the wheel electronics. If you have questions, see an authorized Audi dealer or authorized Audi Service Facility.
- An incorrect display or a malfunction in the tire pressure monitoring system can occur after using the tire mobility kit*. Have the sensors replaced by an authorized Audi dealer or authorized Audi Service Facility.
- The system complies with United States FCC regulations and ISED regulations ⇒ *page 325*.

Displaying tire pressures and temperatures

Applies to: vehicles with tire pressure monitoring system

Requirement: you must be driving the vehicle.

- ▶ Applies to MMI: Select on the home screen: **VEHICLE > Settings & Service > Tire pressure monitoring > Display tire pressure**.

The current tire pressures are shown in green, yellow, or red numbers:

- **Green:** the current tire pressure and the specified tire pressure are approximately the same.
- **Yellow:** the current tire pressure is lower than the specified tire pressure.
- **Red:** the current tire pressure is much lower than the specified tire pressure.

The specified tire pressure is the last tire pressure that was stored ⇒ *page 291*.

Note that the tire pressure also depends on the temperature of the tire. The tire pressure increases as the tires become warmer while driving. ▶

! WARNING

Read and follow the important information and notes ⇒ page 290.

i Tips

The tire pressure or temperature is not displayed while the vehicle is stationary and in adaptation mode. Dashes --.-- are shown in place of the pressure and temperature.

⚠ Tire pressure loss

Applies to: vehicles with tire pressure monitoring system

If the **⚠** indicator light turns on, the tire pressure is too low compared to the specified pressure. Check and store the tire pressure(s) the next time it is possible ⇒ page 291.

⚠ Flat tire! Safely stop vehicle. Please check all tires and store pressures in MMI

If the indicator light turns on and the message appears, the tire pressure has reached a critical level compared to the specified pressure. Avoid unnecessary steering and braking maneuvers. Adapt your driving style to the situation. Stop as soon as possible and check the tire(s). If it is possible to continue driving, see an authorized Audi dealer or authorized Audi Service Facility immediately and have your tire(s) repaired or replaced if necessary.

! WARNING

Read and follow the important information and notes ⇒ page 290.

Storing new tire pressures

Applies to: vehicles with tire pressure monitoring system

The tire pressure specifications must be stored correctly for the tire pressure monitoring system to function reliably.

It is always necessary to store the tire pressures when the tire pressures are modified, for example due to a change in load or when new sensors are installed.

- ▶ Before storing the tire pressures, make sure the tire pressures of all four tires meet the speci-

fied values and are adapted to the load ⇒ page 280, fig. 174. Only correct and store the pressure in tires whose temperature is approximately the same as the ambient temperature. If the temperature of the tire is higher than the ambient air temperature, the tire pressure must be increased approximately 3 PSI (0,2 bar) above the value on the sticker.

- ▶ Switch the ignition on.
- ▶ Applies to MMI: Select on the home screen: **VEHICLE > Settings & Service > Tire pressure monitoring > Store tire pressure > Yes, store now.**
- ▶ If the changed tire pressures are not displayed on the MMI, drive the vehicle for approximately 10 minutes so that the sensor signal from the wheels is received again.

During this adaptation phase, --.-- is displayed for the pressure and temperature and the tire pressure monitoring system is only partially available. It only provides a warning if one or more tire pressures is below the minimum permitted specified pressure.

⚠ Tire pressure: wheel change detected. Please check all tires and store pressures in MMI

If the indicator light turns on and the message appears, the system has detected that the location of the sensors has changed due to a wheel replacement, or new sensors have been installed. Store the new tire pressures.

! WARNING

Read and follow the important information and notes ⇒ page 290.

Malfunctions

Applies to: vehicles with tire pressure monitoring system

TPMS Tire pressure: malfunction! See owner's manual

If the **TPMS** indicator light appears after switching the ignition on or while driving and the **⚠** indicator light also blinks for approximately one minute and then stays on, then there is system malfunction. The following are examples of situations that could cause a malfunction: ▶

- If the message appears at the end of the adaptation phase, the system may not detect one or several of the wheel sensors necessary for pressure monitoring. This may result from one or more wheels without wheel sensors or with incompatible wheel sensors being installed.
- A wheel sensor or another component has failed.
- Using snow chains can affect the function of the system because of the shielding effect of the chains.
- The tire pressure monitoring system is not available due to a malfunction.
- Transmitters with the same frequency, such as headphones or remote controlled devices, may cause a temporary system malfunction due to the strong electromagnetic field.

The **TPMS** indicator light and the message turn off once the tire pressure monitoring system is available again. If you cannot correct the malfunction and the **TPMS** indicator light stays on, drive immediately to an authorized Audi dealer or authorized Audi Service Facility to have the malfunction repaired.

Care and cleaning

General information

Regular, proper care helps to maintain your vehicle's value. It can also be a requirement when submitting warranty claims for corrosion damage and paint defects on the body.

The required cleaning and care products can be obtained from an authorized Audi dealer or authorized Service Facility. Read and follow the instructions for use on the packaging.

WARNING

- Using cleaning and care products incorrectly can be dangerous to your health.
- Always store cleaning and care products out of reach of children to reduce the risk of poisoning.

Car washes

The longer that deposits such as insects, bird droppings, tree sap or road salt remain on the vehicle, the more the surface can be damaged. High temperatures such as those caused by sunlight increase the damaging effect.

Before washing, rinse off heavy deposits with plenty of water.

Stubborn deposits such as bird droppings or tree sap are best removed with plenty of water and a microfiber cloth.

Also, wash the underside of your vehicle once road salt stops being used for the season.

Pressure washers

When washing your vehicle with a pressure washer, always follow the operating instructions provided with the pressure washer. This is especially important in regard to the pressure and spraying distance. Do not aim the spray directly at the seals on the side windows, doors, hood, luggage compartment lid, or sunroof*, or at tires, rubber hoses, insulating material, sensors*, camera lenses*, or the laser scanner*. Maintain a distance of at least 16 inches (40 cm).

Do not remove snow and ice with a pressure washer.

Never use cone nozzles or high pressure nozzles.

The water temperature must not be above 140 °F (60 °C).

Automatic car wash

Spray off the vehicle before washing.

Make sure that the windows and roof* are closed and the windshield wipers are off. Make sure that the vehicle is still able to roll during the washing process in the car wash. Follow instructions from the car wash operator, especially if there are accessories attached to your vehicle.

If possible, use car washes that do not have brushes.

Washing by hand

Clean the vehicle starting from the top and working downward using a soft sponge or cleaning brush. Use solvent-free cleaning products.

Washing vehicles with matte finish paint by hand

To reduce the risk of damaging the paint when washing, first remove dust and large particles from your vehicle. Insects, grease spots, and fingerprints are best removed with a special cleaner for matte finish paint.

Apply the product using a microfiber cloth. To reduce the risk of damaging the paint surface, do not use too much pressure.

Rinse the vehicle thoroughly with water. Then clean using a neutral shampoo and a soft microfiber cloth.

Rinse the vehicle thoroughly again and let it air dry. Remove any water residue using a chamois.

WARNING

- To reduce the risk of accidents, only wash the vehicle when the ignition is off and follow the instructions from the car wash operator.
- To reduce the risk of cuts, protect yourself from sharp metal components when

washing the underbody or the inside of the wheel housings.

- After washing the vehicle, the braking effect may be delayed due to moisture on the brake rotors or ice in the winter. This increases the risk of an accident. The brakes must be dried with a few careful brake applications.

Note

- If you wash the vehicle in an automatic car wash, you must fold the exterior mirrors in to reduce the risk of damage to the mirrors. Power folding exterior mirrors* must only be folded in and out using the power folding function.
- To reduce the risk of damage to the rims and tires, compare the width between the wheels on your vehicle with the distance between the guide rails in the car wash.
- To reduce the risk of damage, compare the height and width of your vehicle with the height and width of the inside of the car wash.
- Make sure there is sufficient ground clearance when driving into a car wash with a conveyor belt ⇒ *page 119*. There is risk of damage because the vehicle could come in contact with the guide rails.
- Using a pressure washer incorrectly can cause damage. Never direct a stream of wa-

ter directly onto electrical/electronic components when cleaning the engine compartment. Such components can be seriously damaged by the entry of fluids and by pressure, and this can lead to component failure.

- To reduce the risk of paint damage, do not wash the vehicle in direct sunlight.
- To reduce the risk of damage, do not wash decorative decals* with a pressure washer.
- To reduce the risk of damage to the surface, do not use insect removing sponges, kitchen sponges, or similar items.
- When washing matte finish painted vehicle components:
 - To reduce the risk of damage to the surface, do not use polishing agents or hard wax.
 - Never use protective wax. It can destroy the matte finish effect.
 - Do not place any stickers or magnetic signs on vehicle components painted with matte finish paint. The paint could be damaged when the stickers or magnets are removed.

For the sake of the environment

Only wash the vehicle in facilities specially designed for that purpose. This will reduce the risk of dirty water contaminated with oil from entering the sewer system.

Cleaning and care information

When cleaning and caring for individual vehicle components, refer to the following tables. The information contained there is simply recommendations. For questions or for components

that are not listed, consult an authorized Audi dealer or authorized Audi Service Facility. Also follow the information found in ⇒ .

Exterior cleaning

Component	Situation	Solution
Windshield wiper blades	Deposits	Soft cloth with glass cleaner, ⇒ <i>page 64</i>
Headlights/ tail lights	Deposits	Soft sponge with a mild soap solution ^{a)}

Component	Situation	Solution
Sensors/ camera lenses	Deposits	Sensors: soft cloth with a solvent-free cleaning product Camera lenses: soft cloth with an alcohol-free cleaning solution
	Snow/ice	Hand brush/solvent-free de-icing spray
Laser scanner	Deposits	Soft sponge with a mild soap solution ^{a)}
Wheels	Road salt	Water
	Brake dust	Acid-free special cleaning solution
Exhaust tail pipes	Road salt	Water, cleaning solution suitable for stainless steel, if necessary
Decorative parts and trim	Deposits	Mild soap solution ^{a)} , cleaning solution suitable for stainless steel, if necessary
Rubber seals	Deposits	Microfiber cloth with a mild soap solution ^{a)}
	Frost	Protect the seals on doors, covers, and lids from freezing using a suitable care product
Paint	Paint damage	Repair with touch-up paint
	Spilled fuel	Rinse with water immediately
	Surface rust	Rust remover, then treat with hard wax; for questions, consult an authorized Audi dealer or authorized Audi Service Facility.
	Corrosion	Have it removed by an authorized Audi dealer or authorized Audi Service Facility.
	Water no longer beads on the surface of clean paint	Treat with hard wax (at least twice per year)
	No shine even though paint has been protected/paint looks poor	Treat with suitable polish; then apply paint protectant if the polish that was used does not contain any protectant
	Deposits such as insects, bird droppings, tree sap, and road salt	Dampen with water immediately and remove with a microfiber cloth
	Grease-based contaminants such as cosmetics or sunblock	Remove immediately with a mild soap solution ^{a)} and a soft cloth
Carbon components	Deposits	Clean the same way as painted parts ⇒ <i>page 293</i>

Care and cleaning

Component	Situation	Solution
Decorative decals	Deposits	Soft sponge with a mild soap solution ^{a)}
	Deposits such as insects, bird droppings, tree sap, and road salt	Dampen with water immediately and remove with a micro-fiber cloth
	Grease-based contaminants such as cosmetics or sunblock	Remove immediately with a mild soap solution ^{a)} and a soft cloth
	Spilled fuel	Blot immediately with a soft cloth and then remove with a mild soap solution ^{a)} and a soft cloth

^{a)} Mild soap solution: maximum two tablespoons of neutral soap in 1 quart (1 liter) of water

Interior cleaning

Component	Situation	Solution
Window glass	Deposits	Glass cleaner, then wipe dry
Decorative parts and trim	Deposits	Mild soap solution ^{a)}
Plastic parts	Deposits	Damp cloth
	Heavier deposits	Mild soap solution ^{a)} , detergent-free plastic cleaning solution, if necessary
Displays/instrument cluster	Deposits	Soft cloth with LCD cleaner; dust in the lower area of the instrument cluster can be removed using a soft brush.
Controls	Deposits	Soft brush, then a soft cloth with a mild soap solution ^{a)}
Safety belts	Deposits	Mild soap solution ^{a)} , allow to dry before letting them retract
Textiles, artificial leather, microfiber	Deposits adhering to the surface	Vacuum cleaner
	Water-based deposits such as coffee, tea, blood, etc.	Absorbent cloth and mild soap solution ^{a)}
	Oil-based deposits such as oil, make-up, etc.	Apply a mild soap solution ^{a)} , blot away the dissolved oil or dye, treat afterward with water, if necessary
	Certain types of deposits such as ink, nail polish, latex paint, shoe polish, etc.	Special stain remover, blot with absorbent material, treat afterward with mild soap solution, if necessary ^{a)}

Component	Situation	Solution
Natural leather	Fresh stains	Cotton cloth with a mild soap solution ^{a)}
	Water-based deposits such as coffee, tea, blood, etc.	Fresh stains: absorbent cloth dried stains: stain remover suitable for leather
	Oil-based deposits such as oil, make-up, etc.	Fresh stains: absorbent cloth and stain remover suitable for leather dried stains: oil cleaning spray
	Certain types of deposits such as ink, nail polish, latex paint, shoe polish, etc.	Spot remover suitable for leather
	Care	Regularly apply conditioning cream that protects from light and penetrates into the material. Use special colored conditioning cream, if necessary.
Refrigerator	Dust and dirt	Clean the ventilation openings in the luggage compartment
	Deposits	Lukewarm water, mild soap solution if necessary ^{a)} , then dry
	Defrosting	Empty the refrigerator, switch it off, and let it thaw with the door open, then dry
Carbon components	Deposits	Clean the same way as plastic components

^{a)} Mild soap solution: maximum two tablespoons of neutral soap in 1 quart (1 liter) of water

WARNING

The windshield must not be treated with water-repelling windshield coating agents. Under unfavorable conditions, such as wetness, darkness, and when the sun is low, these coatings can cause increased glare, which increases the risk of an accident. They can also cause wiper blade chatter.

Note

– **Headlights and tail lights**

- Never clean the headlights or tail lights with a dry cloth or sponge because the lights could be damaged.
- Do not use any cleaning products that contain alcohol, because they could cause cracks to form.

– **Wheels**

- Never use any paint polish or other abrasive materials.
- Damage to the protective layer on the rims, such as stone chips or scratches, must be repaired immediately.

– **Camera lenses**

- Never use warm or hot water to remove snow or ice from the camera lens. This could cause the lens to crack.
- Never use abrasive cleaning materials or alcohol to clean the camera lens. This could cause scratches and cracks.

– **Laser scanner**

- Never use abrasive cleaning materials to clean the laser scanner. This could cause scratches and cracks.

– **Door windows**

- Remove snow and ice on windows and exterior mirrors with a plastic scraper. To reduce the risk of scratches, move the scraper only in one direction and not back and forth.
- Never remove snow or ice from door windows and mirrors using warm or hot water because this could cause cracks to form.
- To reduce the risk of damage to the rear window defogger, do not apply any stickers on the heating wires on the inside of the window.
- **Decorative parts and trim**
 - Never use chrome care or cleaning products.
- **Rubber seals**
 - There is a risk of damage if chemical cleaning solutions or solvents are used.
- **Paint**
 - To reduce the risk of scratches, the vehicle must be free of dirt and dust before polishing or waxing.
 - To prevent paint damage, do not polish or wax the vehicle in direct sunlight.
 - To reduce the risk of paint damage, do not polish away rust spots.
 - Remove cosmetics and sunscreen immediately because they could damage the paint.
- **Decorative decals**
 - Do not clean decorative decals with a pressure washer, because the decals could loosen.
 - To reduce the risk of damage, do not use any rough powder or abrasive cleaning products.
 - To reduce the risk of damage, do not polish decorative decals.
 - Due to the risk of damage, do not use an ice scraper to remove snow and ice on windows with decorative decals on them.
- **Displays and instrument cluster**
 - Make sure that the display and instrument cluster are switched off and have cooled down before cleaning. To switch off the upper and lower display, select on the

MMI home screen: **SETTINGS > Display & Brightness > MMI > Screen cleaning.**

- Displays, the instrument cluster, and the trim surrounding it must not be cleaned with dry cleaning methods because they could become scratched.
- Make sure no fluids enter the spaces between the instrument cluster and the trim, because that could cause damage.
- **Controls**
 - Make sure that no fluids enter the controls, because this could cause damage.
- **Safety belts**
 - Do not remove the safety belts to clean them.
 - Never clean safety belts or their components with chemicals or with corrosive fluids or solvents and never allow sharp objects to come into contact with the safety belts. This could cause damage to the belt webbing.
 - If there is damage to the webbing, the connections, the retractors, or the buckles, have them replaced by an authorized Audi dealer or authorized Audi Service Facility.
- **Textiles/artificial leather/microfiber**
 - Never treat artificial leather or microfiber with leather care products, solvents, floor polish, shoe polish, spot remover, or similar products.
 - Have a cleaning specialist remove stubborn stains to reduce the risk of damage.
 - Never use steam cleaners, brushes, hard sponges, etc. when cleaning.
 - Do not turn on the seat heating* to dry the seat.
 - Objects with sharp edges, such as zippers or rivets on clothing or belts, can cause damage to the surface.
 - Open hook and loop fasteners, for example on clothing, can damage seat covers. Make sure hook and loop fasteners are closed.
- **Natural leather**

- Never treat leather with solvents, floor polish, shoe polish, spot remover or similar products.
- Objects with sharp edges, such as zippers or rivets on clothing or belts, can cause damage to the surface.
- Never use steam cleaners, brushes, hard sponges, etc. when cleaning.
- Do not turn on the seat heating* to dry the seat.
- To help prevent the leather from fading, do not leave the vehicle in direct sunlight for long periods of time. If leaving the vehicle parked for long periods of time, you should cover the leather to protect it from direct sunlight.
- **Refrigerator**
 - Do not try to speed up the defrosting process by applying heat.
 - To help prevent health risks or damage to the refrigerator, do not use any abrasive cleaners, solvents, wax, or strongly scented or aggressive cleaning products.
 - Do not clean the refrigerator with rough cleaning tools such as steel wool.

Tips

- Insects are easier to remove from paint that has been freshly waxed.
- Regular waxing can prevent rust spots from forming.
- Decorative decals can age due to environmental conditions, which can result in damage such as brittleness. The color may fade if exposed to excessive sunlight.

Taking your vehicle out of service

If you would like to take your vehicle out of service for a long period of time, contact an authorized Audi dealer or authorized Audi Service Facility. You can obtain information about the steps to complete depending on the conditions for taking the vehicle out of service (duration, location, etc.).

Emergency assistance

General information

- ▶ Park the vehicle as far as possible from moving traffic in the event of a breakdown. In the event of a flat tire, park the vehicle on a level surface. If you are on a steep hill, be especially careful.
- ▶ Set the parking brake.
- ▶ Switch the emergency flashers on.
- ▶ Have all passengers exit the vehicle. They should move to a safe place, for example behind a guard rail.

WARNING

Follow the steps given above. This is for your own protection and for the safety of other road users.

Equipment

Warning triangle

Applies to: vehicles with warning triangle

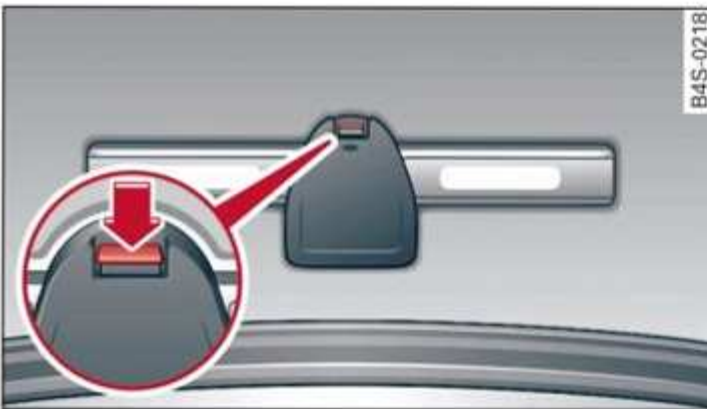

Fig. 175 Luggage compartment lid: warning triangle

The warning triangle placed in the vehicle at the factory is located in the luggage compartment.

- ▶ To remove the warning triangle, press the retainer in the direction of the arrow ⇒ *fig. 175* and fold the holder down.

The luggage compartment lid is only designed to hold the warning triangle offered by the Audi Genuine Accessories program.

WARNING

After use, securely stow the warning triangle in its container again and attach it to the mount. Otherwise, it can fly through the vehi-

cle interior during sudden accelerating or braking maneuvers or in a collision and can cause injuries.

Vehicle tool kit/vehicle jack

Applies to: vehicles with the vehicle tool kit and vehicle jack



Fig. 176 Luggage compartment: cargo area floor

The vehicle tools and vehicle jack* are stored in the luggage compartment under the cargo floor ⇒ *fig. 176*.

- ▶ Lift the cargo floor by the plastic handle ⇒ *fig. 176*.
- ▶ Hook the handle into the luggage compartment weather strip.
- ▶ Applies to: vehicles with spare tire: Turn the handle counter-clockwise and remove the spare tire.
- ▶ Unhook the cargo floor before closing the luggage compartment lid.

Depending on the equipment, the vehicle tool kit may be located under the spare tire*, under another cover, or in the tool box.

Tips

The vehicle jack* does not require any maintenance.

Replacing wheels

Preparation

You must complete the preparation before changing a tire.

- ▶ Read and follow the important safety precautions ⇒ *page 300*.
- ▶ Set the parking brake.

- ▶ Select the "P" selector lever position.
- ▶ When towing a trailer: disconnect the trailer from your vehicle.
- ▶ Lay out the vehicle tool kit ⇒ *page 300* and the spare tire ⇒ *page 304*.
- ▶ Applies to MMI: Select on the home screen: **VEHICLE > Settings & Service > Air suspension: wheel change**.
- ▶ Switch the ignition off.

WARNING

The vehicle must also be secured to prevent it from rolling when using the vehicle jack*. Use suitable objects to block the front and back of the wheel that is diagonal from the wheel with the flat tire.

Removing the caps



Fig. 177 Wheel: wheel bolts with caps

- ▶ Slide the plastic clip from the vehicle tool kit onto the cap until it engages ⇒ *fig. 177*.
- ▶ Remove the cap with the plastic clip.

Anti-theft wheel bolts

Applies to: vehicles with anti-theft wheel bolts

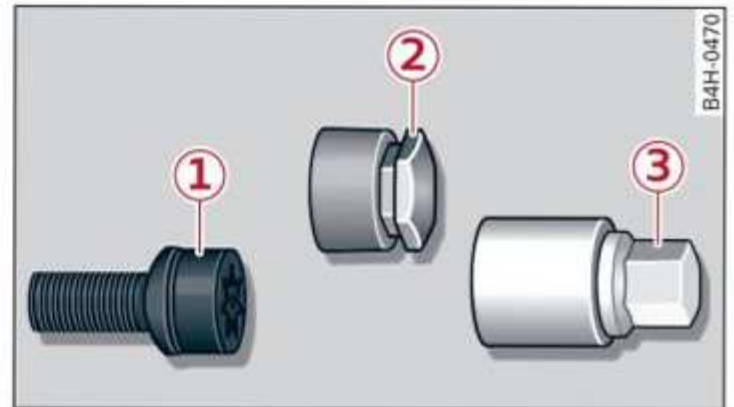

Fig. 178 Anti-theft wheel bolt with cap and adapter

You need a special adapter in the vehicle tool kit to remove the anti-theft wheel bolts.

- ▶ Remove the cap ②.
- ▶ Slide the adapter ③ all the way onto the anti-theft wheel bolt ①.
- ▶ Slide the wheel wrench* from the vehicle tool kit all the way onto the adapter ③.
- ▶ Loosen the wheel bolt ⇒ *page 301*.

Tips

Note the code number for the wheel bolt adapter and store it in a safe place separate from the vehicle. If you need a replacement adapter, contact an authorized Audi dealer or authorized Audi Service Facility and give them the code number.

Loosening the wheel bolts



Fig. 179 Wheel: loosening the wheel bolts

- ▶ Slide the wheel wrench* from the vehicle tool kit all the way onto the wheel bolt¹⁾.
- ▶ Turn the wheel bolt approximately one turn to the left. To achieve the required torque, hold the end of the wheel wrench*. If the wheel bolt will not loosen, press carefully on the wheel wrench* with your foot. Hold onto the vehicle securely while doing this and make sure your footing is stable.

WARNING

To reduce the risk of an accident, only loosen the wheel bolts gently one turn before raising the vehicle with the vehicle jack*.

Raising the vehicle

Applies to: vehicles with vehicle jack

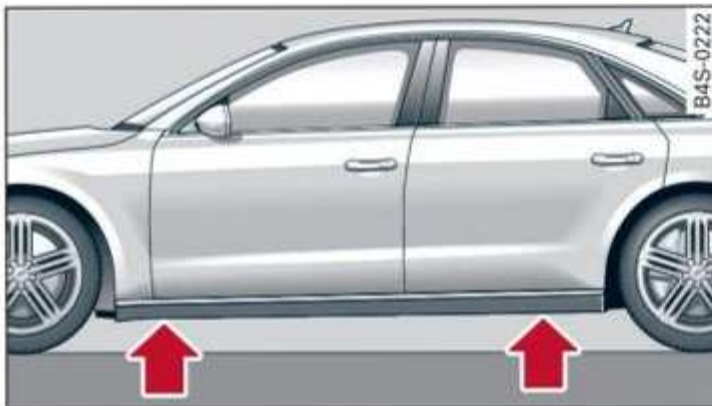

Fig. 180 Sill panels: markings

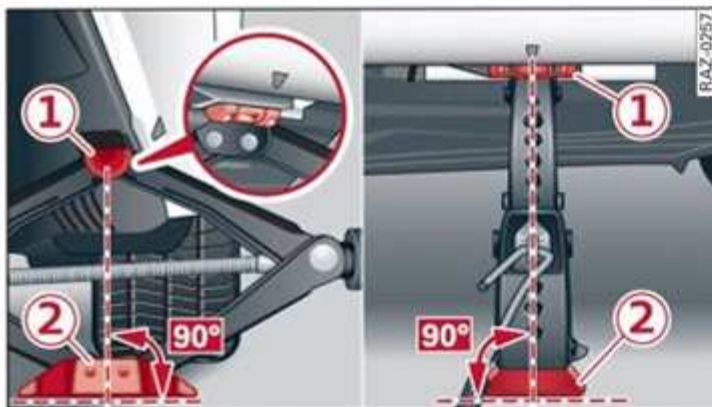







Fig. 181 Sill: positioning the vehicle jack

- ▶ Place the vehicle jack from the vehicle tool kit on a firm surface. Use a flat, stable support if necessary. On a slippery surface such as tile, you should use a non-slip pad such as a rubber mat ⇒ .
- ▶ Find the marking on the sill that is closest to the tire that will be changed ⇒ *fig. 180*. Behind the marking, there is a lifting point on the side sill for the vehicle jack.
 - ▶ Turn the vehicle jack located under the lifting point on the sill to raise the jack until its arm  ⇒ *fig. 181* is located under the designated plastic mount.
 - ▶ Align the vehicle jack so the arm  engages in the designated lifting point in the door sill and the movable base  lies flat on the ground. The base  must be directly under the mounting point .
 - ▶ Continue raising the vehicle jack until the wheel lifts off the ground slightly.
- To reduce the risk of injury, make sure no one is in the vehicle before raising it.
 - Make sure the vehicle jack is stable. The risk of injury is increased when the ground is slippery or soft, because the vehicle jack could slide or sink.
 - Only raise your vehicle with the vehicle jack provided by the factory. If you use a vehicle jack designed for another vehicle, your vehicle could slip and cause injury.
 - Position the vehicle jack only at the designated mounting points on the side sill and align the jack. Otherwise, the vehicle jack could slip and cause an injury if it does not have sufficient hold on the vehicle.
 - To reduce the risk of injury, do not raise any other vehicles or other loads using the vehicle jack provided by the factory.
 - Changes in temperature or load can affect the height of the vehicle.
 - To reduce the risk of an accident, never start the engine when the vehicle is raised.
 - To reduce the risk of injury, no work should be performed under the vehicle while it is raised.

¹⁾ You need the matching adapter in order to loosen and tighten anti-theft wheel bolts* ⇒ *page 301*.

! Note

Do not lift the vehicle by the sill. Position the vehicle jack only at the designated mounting points on the side sill. Otherwise, your vehicle could be damaged.

Removing and installing a wheel

Fig. 182 Wheel: internal hex socket to turn the wheel bolts



Fig. 183 Wheel: alignment pin in the top hole

Removing a wheel

- ▶ Remove the top wheel bolt completely using the hex socket in the screwdriver handle from the vehicle tool kit ⇒ *fig. 182* and place it on a clean surface.
- ▶ Then install the alignment pin from the vehicle tool kit by hand in the empty wheel bolt hole ⇒ *fig. 183*¹⁾.
- ▶ Remove the rest of the wheel bolts.
- ▶ Remove the wheel ⇒ **!**. The alignment pin remains in the hole while doing this.

Installing a wheel

Read the directions on ⇒ *page 303* when installing unidirectional tires.

- ▶ Slide the wheel on over the alignment pin ⇒ **!**
- ▶ Install the wheel bolts and tighten them gently using the hex socket.
- ▶ Remove the alignment pin and tighten the remaining wheel bolt.
- ▶ Carefully lower the vehicle using the vehicle jack*.
- ▶ Tighten the wheel bolts in a diagonal pattern using the wheel wrench*.

The wheel bolts must be clean and loosen and tighten easily. Check the contact surfaces for the wheel and hub. Contaminants on these surfaces must be removed before installing the wheel.

! WARNING

- Read and follow the important information and notes under ⇒ *page 276*.
- Never use the hex socket in the screwdriver handle to tighten the wheel bolts. Using the hex socket will not achieve the required tightening torque, which increases the risk of an accident.

! Note

When removing or installing the wheel, the rim could hit the brake rotor and damage the rotor. Work carefully and have a second person help you.

Unidirectional tires

A unidirectional tire profile is identified by arrows on the tire sidewall that point in the running direction. You must always maintain the specified running direction. This is necessary to ensure the tire's optimal performance in regard to adhesion, running noise, and friction, and to reduce the risk of hydroplaning. ▶

¹⁾ Applies to: vehicles with ceramic brake rotors*: Use a second alignment pin* from the vehicle tool kit for the lowest hole according to the steps described for the first alignment pin.

To benefit fully from the advantages of the uni-directional tire design, you should replace faulty tires as soon as possible and restore the correct running direction on all of the tires.

Finishing

- ▶ Reinstall any covers on the wheel bolts that were removed.
- ▶ Store the vehicle tool kit in its designated place.
- ▶ If the removed wheel does not fit in the spare wheel well, store it securely in the luggage compartment ⇒ *page 94*.
- ▶ Check the tire pressure on the installed wheel as soon as possible.
- ▶ Correct the tire pressure and store it in the MMI ⇒ *page 289* or ⇒ *page 291*.
- ▶ The wheel bolts must be tightened to 90 ft lbs (120 Nm). Have them checked as soon as possible with a torque wrench. Drive carefully until then.
- ▶ Have the faulty wheel replaced as soon as possible.

Space-saving spare tire

Applies to: vehicles with space-saving spare tire (compact spare tire)

The spare tire is intended for short-term use only. Have the damaged tire checked and replaced if necessary by an authorized Audi dealer or authorized Audi Service Facility as soon as possible.

There are some restrictions on the use of the compact spare tire. The compact spare tire has been designed specifically for your type of vehicle. Do not replace it with the spare tire from another type of vehicle.

The compact spare tire is located in the luggage compartment under the cargo floor ⇒ *page 300*.

The tire pressure must be adjusted to a specified value listed on the tire pressure sticker ⇒ *page 280, fig. 174*.

Snow chains

For technical reasons, the use of snow chains on the compact spare tire is not permitted.

If you have to drive with snow chains and a front tire fails, mount the spare tire in place of a rear tire. Install the snow chains on the rear tire that you removed, and install that in place of the front tire that failed.



WARNING

- After installing a spare tire, the tire pressure must be checked as soon as possible.
- Do not drive faster than 50 mph (80 km/h) with a compact spare tire. Driving faster than that increases the risk of an accident.
- To reduce the risk of an accident, avoid hard acceleration or braking and driving fast around curves with the compact spare tire.
- To reduce the risk of an accident, never drive with more than one compact spare tire.
- Normal summer or winter tires must not be mounted on the compact spare wheel rim.

Jump starting

Preparation

You should only perform the following steps if you have the necessary technical knowledge and tools.

If the engine does not start because the vehicle battery is drained, you can jump start your vehicle using another vehicle. Jump start cables are needed to do this.

Both vehicle batteries must have 12 V nominal voltage. The voltage capacity (Ah) of the vehicle battery that is giving power must not be less than the capacity of the drained vehicle battery.

Jump start cable

Only use a jump start cable with a large enough diameter. Note the manufacturer's specifications.

Only use a jump start cable with insulated terminal clamps.

Positive cable - usually red.

Negative cable - usually black.

! WARNING

- A drained battery can freeze at temperatures around 32 °F (0 °C). If the vehicle battery is frozen, it must be thawed before connecting the jump start cables. If it is not, the risk of an explosion and chemical burns increases. After jump starting the vehicle, drive to an authorized Audi dealer or authorized Audi Service Facility immediately to have the vehicle battery checked.
- Read the warnings when working in the engine compartment ⇒ *page 253*.
- Handling the jump start cables incorrectly may cause the vehicle battery to explode and lead to serious injuries.

! Note

Jump start cables can cause considerable damage to the vehicle electrical system if they are connected incorrectly.

i Tips

- There must be no contact between the vehicles, or else voltage could flow when connecting the positive terminal and drain the vehicle battery of the vehicle providing the jump start.
- The drained vehicle battery must be connected correctly to the electrical system.
- Switch off electrical equipment that is not needed.

Jump starting

Both jump start cables must be connected in the correct order.

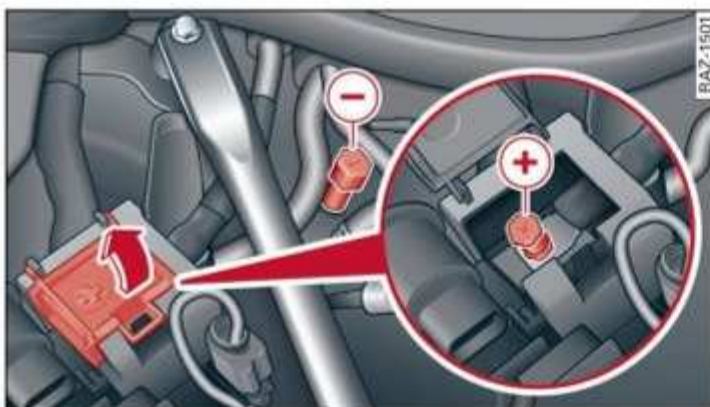

Fig. 184 Engine compartment: connectors for jump start cables or a charger

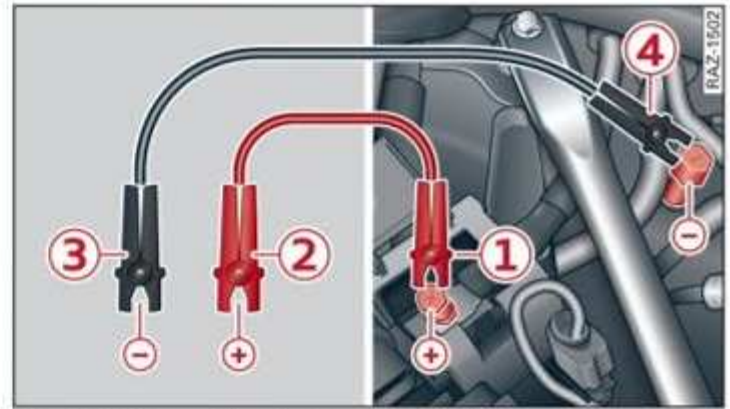

Fig. 185 Connecting the jump start cables

The jump start cable connections are located in the engine compartment.

Follow the information about the vehicle battery ⇒ *page 264*.

Connecting the positive cable (red) to the positive terminal

- ▶ Open the red cover on the positive terminal ⇒ *fig. 184*.
- 1. Attach one end of the positive cable (red) to the jump-start pin ① ⇒ *fig. 185* on your vehicle.
- 2. Attach the other end of the positive cable (red) to the positive terminal ② on the power source.

Connecting the negative cable (black) to the negative terminal

- 3. Attach one end of the negative cable (black) to the negative terminal ③ on the power source.
- 4. Attach the other end of the negative cable (black) to the jump-start pin ④ on the vehicle.

Starting the engine

- ▶ Start the engine in the vehicle giving the charge and let it run at idle.
- ▶ Now start the engine in your vehicle, which has the drained battery.
- ▶ If the engine does not start, stop the starting procedure after 10 seconds and then repeat it after approximately 30 seconds.
- ▶ Turn on the rear window defogger in your vehicle in order to reduce any voltage peaks that may occur when disconnecting the jump start cables. The headlights must be switched off. ▶

- ▶ With the engines running, remove the cables in reverse order of the way they were installed.
- ▶ Close the red cover on the positive terminal.

WARNING

- Never connect the jump start cable directly to your vehicle battery. Only use the connections in the engine compartment.
- Do not touch the non-insulated parts of the terminal clamps. The cable must also not come into contact with vehicle components that conduct electricity when it is connected to the positive vehicle battery terminal. This can cause a short circuit.
- The plugs on the battery cells must not be opened.
- Keep ignition sources (such as open flames, burning cigarettes, etc.) away from the vehicle batteries to reduce the risk of an explosion.
- Route the jump start cables so they cannot get caught in the moving parts in the other vehicle's engine compartment.

Note

Please note that the connecting process previously described for the jump start cables is intended for when your vehicle is being jump started.

Tips

Make sure that the connected jump start cables have sufficient contact with metal.

Towing

General information

You should only perform the following steps if you have the necessary technical knowledge and tools.

Towing requires a certain amount of practice. Audi recommends contacting a towing company to have the vehicle transported.

You should only have your vehicle towed by another vehicle when disabled in exceptional cir-

cumstances. Inexperienced persons should not tow a vehicle.

Notes on towing

When the engine is stopped, the transmission will not be sufficiently lubricated if traveling at high speeds and long distances:

- The maximum permitted towing speed is 30 mph (50 km/h).
- The maximum permitted towing distance is 30 miles (50 km).

Additional information on towing with a tow truck

The vehicle may only be towed with the front axle raised. Do not wrap any chains or cables around the brake lines.

Tow bar and towing cable

The vehicle can be towed with a tow bar or towing cable. Both persons should be familiar with the special considerations when towing, especially when using a towing cable.

Always make sure the traction force does not exceed the permitted level and there are no shock loading conditions. There is always the risk of the coupling becoming overloaded when driving off-road.

For the most safety and security, drive with a tow bar. You should use a towing cable only if a tow bar is not available. Use a towing cable made of synthetic elastic cable similar elastic material.

WARNING

- Towing highly increases the risk of an accident, for example from colliding with the towing vehicle.
- To reduce the risk of an accident, do not allow anyone to remain inside the vehicle when it is being transported by a tow truck or a special transporter.
- Never secure the tow bar or towing cable to parts of the vehicle's axles or suspension. These could be damaged, leading to accidents and severe injuries.

Note

- If normal towing is not possible, for example if the transmission is faulty or if the towing distance is greater than 30 miles (50 km), then transport the vehicle on a special carrier.
- If the vehicle is towed by a tow truck at the axle that is not permitted, this can cause severe damage to the transmission.
- The vehicle must not be tow started for technical reasons.

Tips

- If the power supply is interrupted, then it will not be possible to move the selector lever out of the "P" position. The parking lock must be released using the manual release before towing the vehicle ⇒ *page 108*.
- Switch Audi pre sense* off ⇒ *page 162* when loading the vehicle onto a vehicle carrier, train, ship, or other type of transportation, or when towing the vehicle. This can prevent an undesired intervention from the pre sense* system.
- Follow the local legal regulations for towing.

Towing

Read and follow the important information under ⇒ *page 306*.

Preparations

- ▶ Only secure the towing cable or tow bar at the designated towing loops ⇒ *page 307*, ⇒ *page 308*.
- ▶ Make sure the towing cable is not twisted. Otherwise it could disconnect from the towing loop while towing.
- ▶ Switch the emergency flashers on in both vehicles ⇒ *page 59*. However, do not do this if it prohibited by law.

Towing vehicle (front)

- ▶ Only start to drive when the towing cable is taut.
- ▶ Press the brake pedal very carefully.
- ▶ Avoid sudden braking or driving maneuvers.

Vehicle being towed (rear)

- ▶ Make sure the ignition is switched on so that the steering wheel is not locked and so that you can use the turn signals, the horn, and the windshield wipers if needed ⇒ .
- ▶ Switching it off before the vehicle has stopped may impair the function of the brake booster and power steering. You would then need to use more force to steer and brake the vehicle.
- ▶ Release the parking brake ⇒ *page 114*.
- ▶ Select the "N" selector lever position.
- ▶ Make sure the towing cable is always taut.

WARNING

- Never tow a vehicle using a tow bar or towing cable if the vehicle does not have electrical power.
- If the vehicle loses power while it is being towed, stop towing the vehicle immediately and consult an authorized Audi dealer or qualified repair facility.

Front towing loop

Fig. 186 Front bumper: installing the towing loop

The threaded opening for the towing loop is located on the right side of the front bumper.

- ▶ Remove the towing loop from the vehicle tool kit ⇒ *page 300*.
- ▶ Press the cap inward with brief, strong pressure ⇒ *fig. 186*. The cap will loosen from the bumper.
- ▶ Tighten the towing eye as far as it will go into the mount. Use a suitable object to tighten the towing eye completely and securely in the mount.

- ▶ After using, place the towing loop back in the vehicle tool kit.

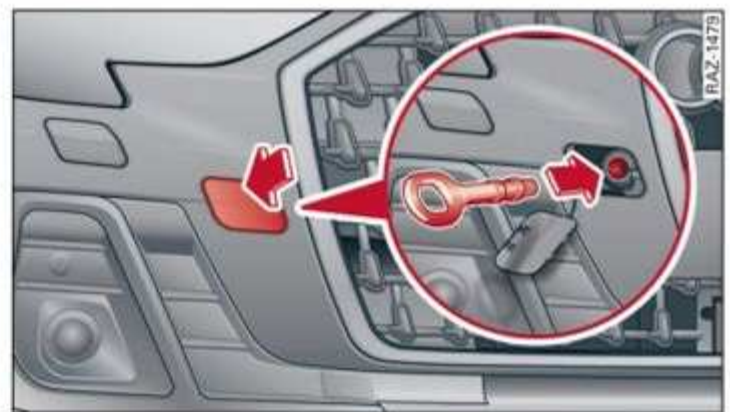
WARNING

If the towing loop is not tightened all the way when installing, the threads may be pulled out when towing the vehicle and result in an accident.

Tips

Depending on the model, the shape of the cap can vary.

Tips

Depending on the model, the shape of the cap can vary.

Rear towing loop

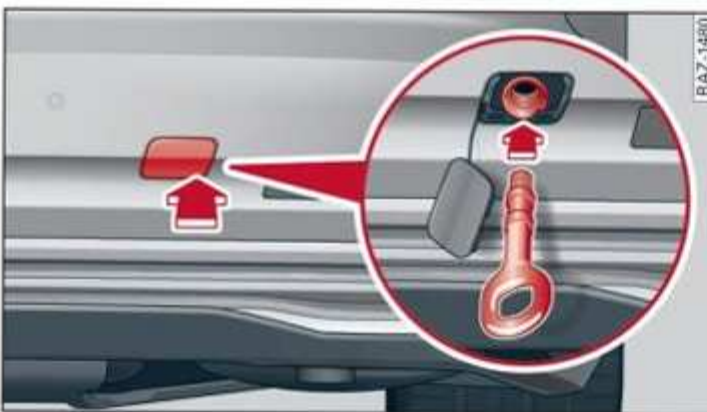

Fig. 187 Rear bumper: installing the towing loop

The threaded opening for the towing loop is located on the right rear of the bumper.

- ▶ Remove the towing loop from the vehicle tool kit ⇒ *page 300*.
- ▶ Press the cap inward with brief, strong pressure ⇒ *fig. 187*. The cap will loosen from the bumper.
- ▶ Tighten the towing eye as far as it will go into the mount. Use a suitable object to tighten the towing eye completely and securely in the mount.
- ▶ After using, place the towing loop back in the vehicle tool kit.

WARNING

If the towing loop is not tightened all the way when installing, the threads may be pulled out when towing the vehicle and result in an accident.

Fuses and bulbs

Fuses

Replacing fuses



Fig. 188 Left side of the cockpit: fuse panel cover ①, left footwell: fuse panel cover ②

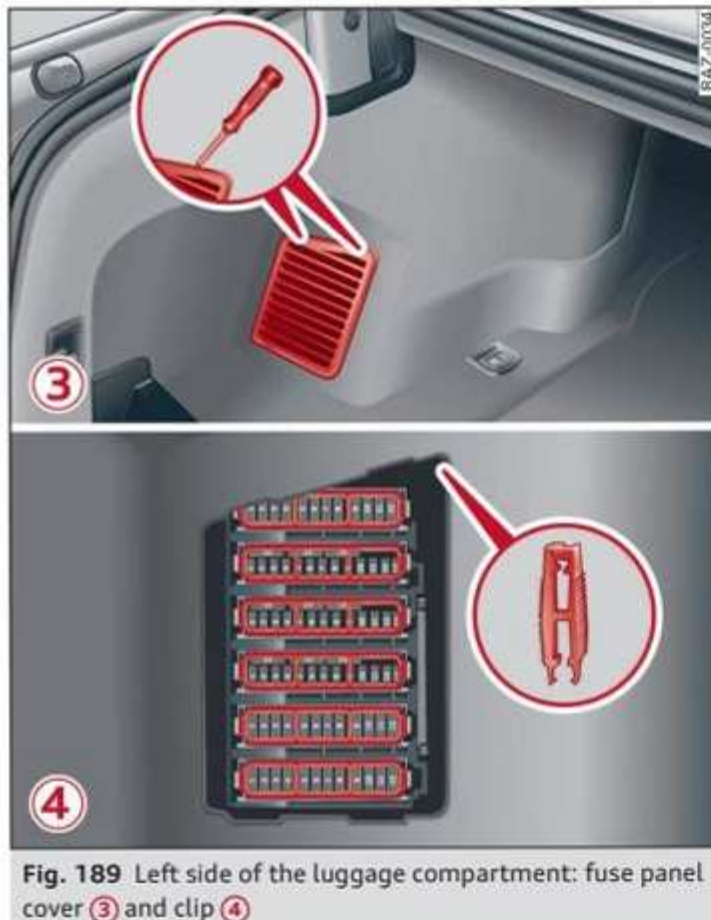

Fig. 189 Left side of the luggage compartment: fuse panel cover ③ and clip ④

Fuses are installed in various locations in your vehicle. The following information only lists fuses that you can change yourself. To have other fuses changed, contact an authorized Audi dealer or authorized Audi Service Facility. The following table does not list fuse locations that are not used.

A fuse that has blown will have metal strips that have burned through.

The fuses are located on the left front side of the cockpit ①, in the left footwell ②, and in the left side of the luggage compartment ③ behind the side trim panel.

- ▶ Switch the ignition and all electrical equipment off.
- ▶ Check the table that follows to see which fuse belongs to the affected equipment.
- ▶ Remove the screwdriver from the vehicle tool kit ⇒ page 300.
- ▶ Remove the appropriate cover.
- ▶ Remove the colored plastic bracket from the fuse panel, if present.
- ▶ Remove the clip from the upper right fuse panel in the luggage compartment ④.
- ▶ Remove the fuse using the clip.
- ▶ Replace the blown fuse only with a fuse that has the same amp rating.
- ▶ Reinstall the plastic bracket, if present.
- ▶ Install the cover.

Fuse color identification

Color	Current rating in amps
Black	1
Gray	2
Purple	3
Pink	4
Light brown	5
Brown	7.5
Red (narrow)	10
Light blue	15
Yellow	20
White or transparent	25
Light green	30
Teal	35

Color	Current rating in amps
Orange	40
Red (wide)	50

WARNING

Do not repair fuses and never replace a blown fuse with one that has a higher amp rating. This can cause damage to the electrical system and increases the risk of fire.

Note

If a new fuse burns out again shortly after you have installed it, have the electrical system checked as soon as possible by an authorized Audi dealer or authorized Audi Service Facility.

Tips

Some of the equipment listed in the following tables applies only to certain model versions or certain optional equipment.

Fuse assignment - footwell

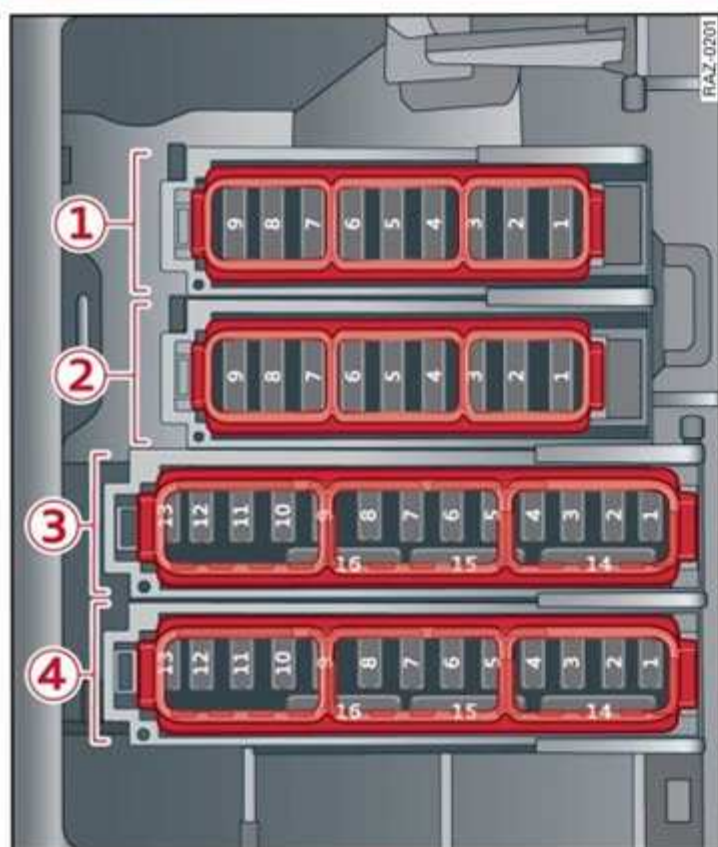

Fig. 190 Left footwell: fuse panel with plastic bracket

Fuse panel ① (brown)

No.	Equipment
1	Ignition coils
2	Engine start, electric drive clutch
3	Windshield wiper control module
4	Left headlight electronics
5	Climate control system blower
6	Instrument panel
7	Windshield wipers
9	Panoramic glass roof

Fuse panel ② (black)

No.	Equipment
1	Engine mount
2	Left rear door control module
3	Windshield washer system/headlight washer system
4	Right headlight electronics
5	Front seat heating
6	Right rear door control module
7	Sockets
8	Left front door control module
9	Auxiliary heating, exterior sound generator

Fuse panel ③ (red)

No.	Equipment
1	Anti-theft alarm system
2	Drive system control module
4	Electronic Toll Collection System (ETC)
5	Horn
6	Parking brake
7	Diagnostic interface
8	Roof electronics control module
9	Driver assistance systems control module
10	Airbag control module
11	Electronic Stabilization Control (ESC), Anti-Lock Braking System (ABS)
12	Climate control system rear control panel, diagnostic connector, light/rain sensor
13	Climate control system, vehicle electrical system control module
14	Right front door control module

Fuse panel ③ (red)	
15	Climate control system compressor, vehicle electrical system control module
16	Brake system pressure reservoir

Fuse panel ④ (black)	
No.	Equipment
2	Engine components, coolant pump, oxygen sensors
3	Exhaust doors, fuel injectors, air intake, motor heating
4	NOx sensor, particulate sensor, biodiesel sensor, exhaust doors
5	Brake light sensor
6	Engine valves, camshaft adjustment
7	Heated oxygen sensor, mass airflow sensor
8	Coolant pump, high pressure pump, mass airflow sensor, fuel pressure regulation
9	48 volt starter generator, 48 volt coolant pump, motor components
10	Oil pressure sensor, oil temperature sensor
11	48 volt starter generator, 48 volt coolant pump, 12 volt starter generator
12	Engine valves, engine mount
13	Engine cooling
14	Drive system control module, fuel injectors
15	Heated oxygen sensors, charge air cooling, ignition coils
16	Fuel pump

Fuse assignment- cockpit

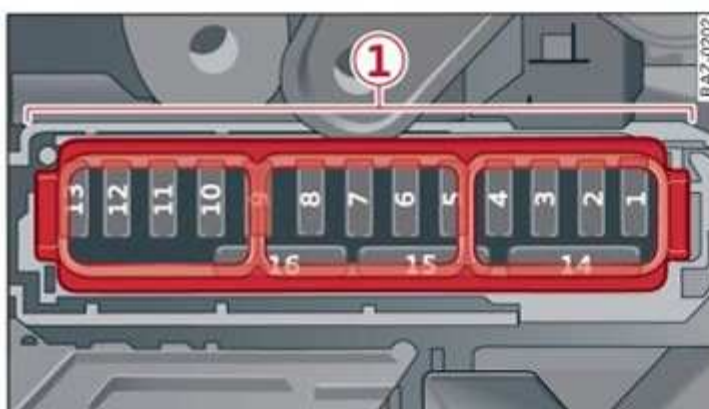

Fig. 191 Left side of the cockpit: fuse panel with plastic clip

Fuse panel ① (black)	
No.	Equipment
1	Climate control system, air quality sensor
2	Audi phone box, exterior antenna
3	Climate control system, fragrance system, particulate matter sensor
4	Head-up display
5	USB ports with charging function
6	Instrument panel
7	Steering column lock
8	Upper/lower display
9	Instrument cluster
10	Volume control
11	Light switch, switch panels
12	Steering column electronics
14	MMI Infotainment system control module
15	Steering column adjustment
16	Steering wheel heating

Fuse assignment - luggage compartment

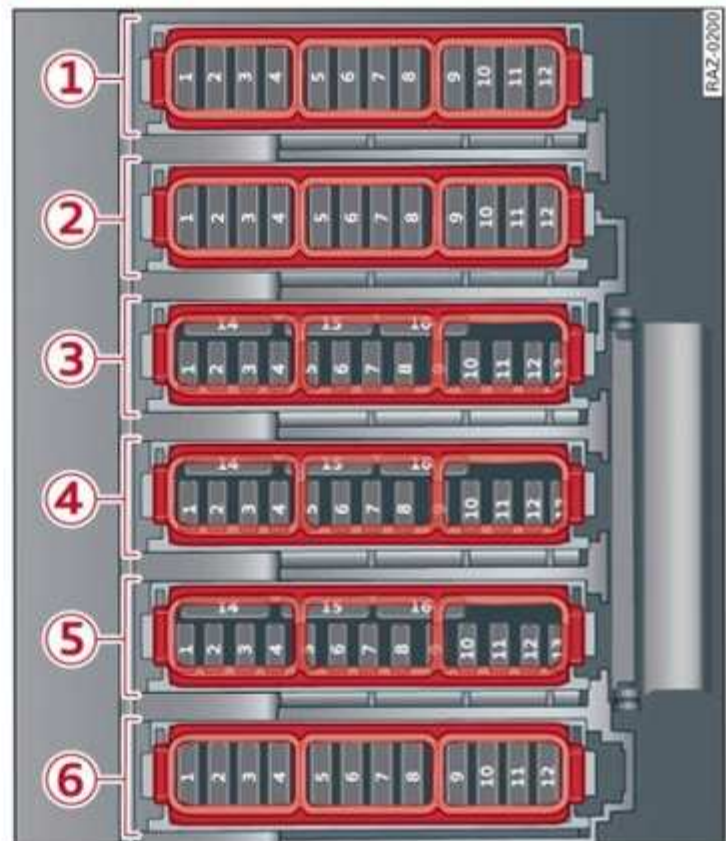

Fig. 192 Left side of the luggage compartment: fuse panel with plastic clip

Fuse panel ① (black)	
No.	Equipment
1	Thermal management
5	Air suspension/suspension control
6	Automatic transmission control module
7	Right rear seat adjustment
8	Rear seat heating
9	Convenience system control module, left tail light
10	Front belt tensioner on driver's side
11	Luggage compartment lid central locking, fuel filler door, convenience system control module, sunshade
12	Luggage compartment lid control module

Fuse panel ② (red)	
No.	Equipment
1	Rear climate control system blower
2	Exterior antenna
3	Exhaust treatment, engine sound control module
4	Rear climate control system control panel
5	Right trailer hitch light
6	Trailer hitch positioning motor
7	Trailer hitch release
8	Left trailer hitch light
9	Trailer hitch socket, battery 48 V
10	Allroad sport differential
11	Exhaust treatment

Fuse panel ③ (brown)	
No.	Equipment
1	Driver assistance systems control module
2	Rear Audi phone box
3	Rear seat adjustment
4	Side assist
5	Screens in the rear, Rear Seat Remote
6	Tire pressure monitoring system
7	Emergency call and communication control module
8	Auxiliary heating radio receiver, tank module

Fuse panel ③ (brown)	
9	Automatic transmission selector lever
10	TV tuner, data exchange and telematics control module
11	Convenience access and start authorization control module
12	Garage door opener
13	Rearview camera, peripheral cameras
14	Convenience system control module, right tail light
15	Left rear seat adjustment
16	Front belt tensioner on front passenger's side

Fuse panel ④ (black)	
No.	Equipment
1	Seat ventilation, rear seat heating, rearview mirror, refrigerator, diagnostic connection
2	Diagnostic interface
3	Engine sound control module
4	Transmission heating valve
5	Engine start, electric drive
7	Active accelerator pedal
8	Night vision assist, active roll stabilization
9	Adaptive cruise assist
11	Intersection assistant, driver assist systems, radar systems, camera systems
12	Exterior sound generator
13	USB connection
14	Right headlight
15	Left headlight

Fuse panel ⑤ (red)	
No.	Equipment
1	Active suspension
2	High-voltage battery emergency cut-off point
3	Refrigerator
4	Electric drive system, power electronics
5	Brake system
6	High-voltage battery water pump
7	Auxiliary climate control

Fuse panel ⑤ (red)	
8	Climate control system compressor
9	Auxiliary battery control module
10	High-voltage battery
11	High-voltage charger
14	Thermal management
15	Thermal management

Fuse panel ⑥ (white)	
No.	Equipment
1	Rear center armrest heating
2	Rear panoramic glass roof
3	DVD drive
5	AC socket
6	Passenger's side rear safety belt tensioner
7	Front center armrest heating
8	Rear footrest heating
11	Rear Seat Remote
12	Driver's side rear safety belt tensioner

Bulbs

Note

Your vehicle is equipped with maintenance-free headlights and tail lights. However, if a light bulb needs to be replaced, please contact an authorized Audi dealer or authorized Audi Service Facility.

Data privacy

Privacy notice

You can find information about responsibility for data privacy in the MMI.

Applies to: MMI: Select on the home screen: **SETTINGS > General > Legal notes > About Audi connect.**

Image recording

Surrounding area monitoring

Applies to: vehicles with surrounding area monitoring

The functionality of the park assist plus requires detecting and evaluating the vehicle's path. This is done by cameras installed permanently on the vehicle that detect objects in the vehicle's surroundings (such as obstacles or guard rails). The live images from the cameras are transmitted to the applicable control module.

The camera images are transferred to the responsible control module for processing and may be stored, depending on vehicle equipment. The control module analyzes the current camera image using image evaluation software. This image evaluation software detects anonymized technical measurements, such as distances to objects. The control module evaluates these technical measurements and makes it possible for the assist systems to control the vehicle as needed.

Data memories

Vehicle control modules

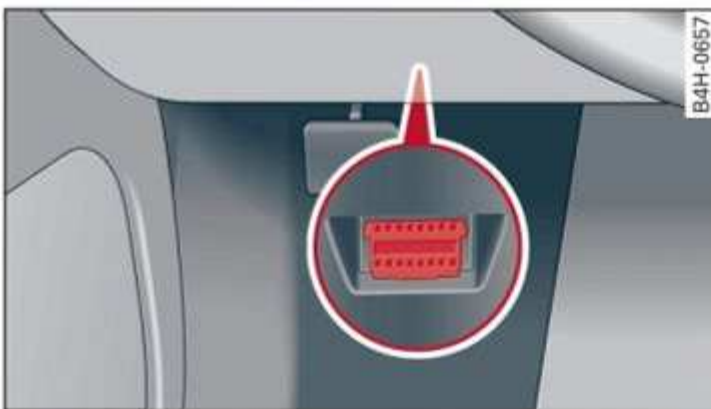

Fig. 193 Driver's side footwell: connection port for the On Board Diagnostic System (OBD)

Your vehicle is equipped with electronic control modules for various vehicle systems such as the airbags. These vehicle control modules store data while driving normally that is required by an authorized Audi dealer or authorized Audi Service Facility for diagnosis and repair purposes. Only certain types of data are recorded for a very short period of time if a control module has detected a system event. No noises, conversations, or images will be recorded in the vehicle.

The data may include information such as the vehicle speed, the direction of travel, and information about the brake system, or also the behavior of the restraint system in the event of an accident. The stored data can be exported and downloaded with special devices, which must be connected directly to the vehicle.

On Board Diagnostic System (OBD)

There is a diagnostic connector socket in the driver's side footwell to read out the various control modules and the event data recorder. Data regarding the function and condition of the electronic control modules is stored in the event memory. Only have an authorized Audi dealer or authorized Audi Service Facility read out and delete the event memory.

WARNING

- Incorrect use of the connection port for the On Board Diagnostic System can cause malfunctions, which can then result in accidents and serious injuries.
- Only allow an authorized Audi dealer or authorized Audi Service Facility to read out the motor data.

Crash data recorder

Event Data Recorder

This vehicle is equipped with an Event Data Recorder (EDR). The main purpose of an EDR is to record, in certain crash or near crash-like situations, such as an airbag deployment or hitting a road obstacle, data that will assist in understanding how a vehicle's system performed. The EDR is designed to record data related to vehicle dynamics and safety systems for a short period of ▶

time, typically 30 seconds or less. The EDR in this vehicle is designed to record such data as:

- How various systems in your vehicle were operating;
- Whether or not the driver and passenger safety belts were buckled/fastened;
- How far (if at all) the driver was depressing the accelerator and/or brake pedal; and,
- How fast the vehicle was traveling.

These data can help provide a better understanding of the circumstances in which crashes and injuries occur. NOTE: EDR data are recorded by your vehicle only if a non-trivial crash situation occurs; no data are recorded by the EDR under normal driving conditions and no personal data (e.g. name, gender, age, and crash location) are recorded. However, other parties, such as law enforcement, could combine the EDR data with the type of personally identifying data routinely acquired during a crash investigation.

To read data recorded by an EDR, special equipment is required, and access to the vehicle or the EDR is needed. In addition to the vehicle manufacturer, other parties, such as law enforcement, that have the special equipment, can read the information if they have access to the vehicle or the EDR.

Assist system monitor

This vehicle is equipped with an Assist System Monitor (ASM). The ASM collects data that is not stored by the EDR in the event of an accident. The main task of the ASM is to make it possible to understand the role and the behavior of the assist systems in these accident situations. In addition to the data that the EDR stores, the ASM records data related to the assist systems starting several seconds before the accident or near-accident. The data collected by ASM depends on the equipment and may include the following information: status information of the assist systems (for example, if they are switched on or off, system events, etc.), control interventions (for example,

by ESC, ABS, Audi pre sense, etc.), and assist system settings (such as speed settings).

Special devices and access to the vehicle or to the ASM are necessary in order to read the data from the ASM memory. In addition to the vehicle manufacturer, third parties such as law enforcement authorities can also read and analyze the stored data if they have access to the vehicle or to the ASM.

Data usage

Audi can read out the information stored in the data memories or similar data, or give this information to third parties, especially in the following situations:

- If the vehicle owner or lessee agrees
- If there is an official request from the police
- If a court or authorities request it

If legally permitted, Audi can also use the data for analysis of vehicle operation and safety performance or provide this data to third parties for research purposes.

Data memory for autonomous driving¹⁾

Applies to: vehicles with data memory for autonomous driving

When park assist plus is active ⇒ *page 179*, data is stored in a memory in the vehicle. This data is encrypted and is continuously overwritten by more current data after a few seconds. The data is erased when the ignition is switched off.

In certain situations, such as if an airbag has deployed or a parking process has been ended, technical data about this may be stored in the data memory for autonomous driving. The data memory for autonomous driving is a read-only memory that has a limited amount of storage space. If the storage space is full, the oldest data will be overwritten with the newest data. ►

¹⁾ System availability may be limited depending on the market.

Exporting data

You can read out the data memory for autonomous driving and export this data to a USB stick. The settings depend on the vehicle equipment.

Requirement: the vehicle must be stationary, the automated systems must not be active, and the ignition must be switched on. A USB stick must be connected to the USB input.

- ▶ Applies to: MMI: Select on the home screen: **SETTINGS > Data management > Statistics.**
- ▶ Follow the instructions in the MMI.

The export will be canceled if you switch menus, for example.

Recorded data

The following data is recorded with encryption:

- Interactions from the driver (such as pressing the brake pedal)
- Vehicle dynamics (such as speed)
- Status of automated systems
- Control requests
- Relevant measurements from monitoring the surroundings
- Image data from monitoring the surroundings
- System status, timestamp, and vehicle location when deactivating/activating park assist plus

You can find additional information in the MMI:

- Applies to: MMI: Select on the home screen: **SETTINGS > General > Legal notes > About the data memory.**

Tips

- The data is processed and stored locally in the vehicle. It is not automatically transmitted to Audi or other third parties, for example through the cloud. The owner or driver is responsible for the data. Audi does not have access to it.
- For additional information and the evaluation of data, please contact Audi Customer Care.

Transmitted information

Data collection

Applies to: vehicles with data collection

Depending on the country, Audi may collect data for the following purposes, for example: offer and product optimization, public safety, provision of Audi connect remote vehicle services, and adaptation to customer expectations. For example, various technical function data, environmental data, driving data, and usage data will be collected for a specific purpose and forwarded to Audi. The data will be sent from the vehicle at the time the data was collected.

Applies to: MMI: You can find additional information about data collection in the MMI. Select on the home screen: **SETTINGS > General > Legal notes > About Audi connect.**

If you would like to deny data transmission to Audi, contact an authorized Audi dealer or authorized Audi Service Facility for more information. You also have the option to deactivate data transmission within the privacy settings.

Privacy settings

Applies to: vehicles with Audi connect

- ▶ Applies to MMI: Select on the home screen: **SETTINGS > Privacy mode settings.**
- ▶ To display additional information about the privacy settings and the associated symbols in the status bar, press  in the MMI.

Requirement: the ignition must be switched on.

Setting the maximum privacy settings

When the **Activate privacy mode** function is switched on, the data connection is deactivated or sending of data is restricted, but all safety-related, legal, or contractually required Audi connect services remain activated. The majority of the Audi connect services are deactivated.

When the function is switched off, the data connection will be available in order to use Audi connect services. After switching off the **Activate privacy mode** function, check the individual data 

categories as described under *Adjusting individual privacy settings*.

Adjusting individual privacy settings

In the MMI, you can adjust individually which data should be transmitted from the vehicle. If you switch on a data category, the data will be transmitted.

You can also deactivate individual services for your vehicle at my.audi.com if you are logged into the vehicle as the key user ⇒ *page 34*. These deactivated services will not be available in the vehicle. For additional information, visit my.audi.com.¹⁾

Note

You are responsible for all precautions taken for data protection, anti-virus protection, and protection against loss of data on mobile devices that are used to access the Internet through the Wi-Fi hotspot.

Tips

- The following interfaces are not affected by changes to the privacy settings: Bluetooth, Bluetooth Low Energy (BLE), Wi-Fi, smartphone interface, Near Field Communication (NFC), charging communication (high-voltage system), Electronic Toll Collect (ETC), On-Board Diagnostic System (OBD) if equipped.
- If the maximum privacy settings are switched on, your vehicle may not receive certificates and security updates for establishing a secure connection, depending on vehicle equipment. In order to receive security updates and certificates, switch the maximum privacy settings off for at least ten minutes every three months. Make sure that your vehicle is connected to the Internet. A symbol in the MMI status bar indicates if the required data connection is available ⇒ *page 25*.
- If the transmission of data is limited, it will have the following effects on the exchange

of data for Audi connect services and emergency calls, if equipped:

- The emergency call function will remain available without restrictions and will continue to transmit data.
- If an online roadside assistance call is initiated, no data will be transmitted, but a call will be made.
- Online Car Care will remain available without restrictions and continue to transmit data, as long as the vehicle's embedded SIM card is connected to the mobile phone network.
- If the Geofencing Alert, Speed Alert, and/or Valet Alert services have been activated by the key user, then they will remain available without restrictions and continue to transmit data.
- Stored destinations (favorites, last destinations) are only stored in the vehicle. If you allow transmission of data again, these destinations will be synchronized via the myAudi account. To prevent synchronization of destinations, delete the destinations before you allow data to be transmitted again.

Audi connect

Applies to: vehicles with Audi connect Infotainment

Audi collects, uses, stores and shares your personal information, such as contact data, vehicle data, usage data, driving data and precise geolocation, in order to provide you with the products and services you have purchased or requested, and for a number of other purposes, for example, to track quality issues, to performance and safety, to meet our internal compliance or legal requirements and to market to customers and potential customers. For a more complete list of the data we collect, how we use it and with whom we share it, please visit your Audi national/sales region website at www.audi.com.

The collection, use and sharing may vary depending on your model and model year, your subscription status, or the service offering. For example, ►

¹⁾ In certain countries.

collection, use and sharing may vary between Audi connect services, if you have designated a key user, or if you are driving a model equipped with persistent data logging. Please review the complete Privacy Statement to understand our data handling practices with respect to a particular service.

You can find additional information about our data privacy practices in your MMI.

- ▶ Applies to: MMI: On the home screen, select: **SETTINGS > General > Legal notes > About Audi connect.**

Information about our privacy practices in conjunction with the mobile Audi connect application can be found in the Application's Privacy Statement.

For additional information about the privacy practices relating to Audi connect, myAudi, or other websites, applications or online services as well as your obligations with respect to using these services, and for additional information regarding Audi connect terms and conditions, please visit your Audi national/sales region website at www.audi.com.

Accessories and technical changes

Warranty

Your vehicle is covered by various warranties:

- New Vehicle Limited Warranty
- Limited Warranty Against Corrosion Perforation
- Applies to: USA models: Emissions Control System Warranties: *Federal Emissions Control System Defect Warranty, Federal Emissions Performance Warranty*
- Applies to: Canada models: Emissions Warranties: *Emissions Control System Defect Warranty, Emissions Performance Warranty*
- Applies to: USA models: Kansas Safety Belt Limited Warranty
- Applies to: USA models: California Emissions Control System Warranties: *Short-term Emissions Defects Warranty, Long-term Emissions Defects Warranty, TZEV models Emissions Defects Warranty, California Emissions Performance Warranty*

You can find detailed information in your Warranty & Maintenance Booklet, in the California Emissions Booklet*, or on the applicable website:

- Applies to: USA: maintenance.audiusa.com
- Applies to: Canada: www.audimaintenance.ca or www.audimaintenance.ca/#/search/fr

Audi Literature Shop

Service information is made available as soon as possible after a model is introduced and can be ordered in the Audi Literature Shop: <http://literature.audiusa.com>

Driving in other countries

Government regulations in the United States and Canada require motor vehicles to comply with emissions regulations and safety standards. Therefore, vehicles that were produced for the U.S. and Canadian markets are different from vehicles produced for other countries.

If you plan to use your vehicle outside of the United States or Canada, it is possible that:

- Fuel may have a significantly lower octane rating. Unsuitable fuels can cause engine damage.
- Proper maintenance and repair work may not be possible because special service equipment, tools, or measuring devices needed for your vehicle may not be available.
- Replacement parts may not always be available.
- Navigation systems for vehicles built for the U.S.A. and Canada will not necessarily work in Europe, and may not work in other countries.

Note

Audi is not liable for damage to the vehicle resulting from these country-specific differences.

Maintenance, repairs, and technical modifications

Observe the safety precautions ⇒ *page 253, General information* and ⇒ *page 302, Raising the vehicle*.

General information

Due to the increasing complexity of technology in these vehicles, as well as the safety and environmental standards that apply, you can only perform a very limited amount of repairs and modifications to the vehicle yourself.

Proof of maintenance work may be required to submit a claim within the warranty period.

We recommend that you have your vehicle serviced by an authorized Audi dealer or authorized Audi Service Facility and that Audi Genuine Parts and Audi Genuine Accessories are used. This helps to ensure that your vehicle's functionality, performance, and safety are not impaired.

Maintenance and repairs

Your vehicle was designed to help keep maintenance requirements to a minimum. Some regular maintenance is required to help ensure that your vehicle runs in a safe, economical, and reliable ►

manner. Please refer to your Warranty & Maintenance Booklet for more detailed information about vehicle maintenance.

When operating the vehicle under more extreme operating conditions, for example when outside temperatures are very low or in very dusty environments, certain maintenance should be performed between the specified intervals.

Usually maintenance and repair work requires special tools, measuring devices, and other equipment that is available to trained vehicle technicians in order to help ensure that your vehicle and all of its systems operate correctly, reliably, and safely. Performing work on the vehicle incorrectly can impair the operation and reliability of your vehicle and may void one or more of your vehicle's warranties.

Technical Modifications

Interference with electronic components, their software, the wiring, and data transfer may cause malfunctions. Because of the way electronic components are interconnected, such malfunctions can also impair systems that are not directly involved. This means that you risk both a substantial reduction in the operational safety of your vehicle and increased wear of vehicle components.

Some convenience functions, such as the convenience turn signal function, individual door opening function, and displays, can be reprogrammed using special workshop equipment. If functions are reprogrammed, the information and descriptions about these functions in this Owner's Manual may no longer apply to the changed functions. Audi recommends that an authorized Audi dealer or authorized Audi Service Facility perform and verify any reprogramming procedures.

WARNING

Maintenance work, repairs, or technical modifications to the vehicle (such as installing additional equipment) that is not performed correctly can cause serious injuries and increase the risk of an accident.

WARNING

The engine compartment in any motor vehicle is a potentially dangerous area and can cause serious personal injury.

- Always use extreme caution when doing any work in the engine compartment. Always follow commonly accepted safety practices and use common sense. Never risk personal injury.
- Never perform any work in the engine compartment unless you know exactly how to carry out the job and have the correct technical information and the correct tools.
- If you are uncertain about what to do, have the work performed by an authorized Audi dealer, an authorized Audi Service Facility, or another qualified workshop. Serious personal injury may result from improperly performed work.

Note

- Maintenance work, repairs, or technical modifications to the vehicle (such as installing additional equipment) that is not performed correctly can cause vehicle damage.
- The New Vehicle Limited Warranty does not cover damage or malfunctions if the recommended intended use of the vehicle and maintenance measures listed in the Audi Owner's Manual and the Warranty & Maintenance Booklet were not followed.
- If emergency repairs must be performed, take your vehicle to an authorized Audi dealer or authorized Audi Service Facility as soon as possible.
- Audi is not liable for damage to the vehicle resulting from failure to comply with these guidelines.

For the sake of the environment

- Regular maintenance can help protect the environment.
- Technical modifications to the vehicle can have a negative impact on fuel consumption and vehicle emissions.

i Tips

Because of your vehicle's aluminum body design, all service and repair procedures affecting the body should be performed by an authorized Audi dealer or authorized Audi Service Facility, who will perform the work according to Audi factory specifications. Only Audi Genuine Parts are used when Audi experts perform repair or service procedures. Failure to use Audi Genuine Parts or Audi Genuine Accessories or performing repairs incorrectly may result in severe vehicle damage, such as corrosion.

Accessories and parts

Consult with an authorized Audi dealer or authorized Audi Service Facility before purchasing accessories or replacement parts. Audi recommends having your vehicle serviced by an authorized Audi dealer or authorized Audi Service Facility and using Audi Genuine Parts and Audi Genuine Accessories.

Audi does not endorse the use of products and accessories that it has not evaluated, even if the product is approved by a certified testing agency or government agency.

Radio communications equipment

A correctly-installed exterior antenna is required for operating radio equipment in the vehicle. Otherwise, the increased electromagnetic waves can cause malfunctions in the vehicle. Observe the regulations in the country where the vehicle is being operated and the instructions from the radio equipment manufacturer.

An authorized Audi dealer or authorized Audi Service Facility can inform you about installation options and radio communications equipment.

! WARNING

- Installing unapproved accessories or incorrect replacement parts can cause vehicle damage and can increase the risk of an accident.
- Never attach accessories, such as telephone holders or cup holders, to the airbag covers

or within the airbag deployment zone, because this increases the risk of injury if the airbag deploys.

- On vehicles that have factory-installed license plate brackets on the front of the vehicle, the brackets may only be replaced with ones that are the same size and made of the same material. Do not install any license plate brackets on the front of vehicles that do not have factory-installed brackets. Otherwise, the function of the system could be impaired.

**Reporting Safety Defects
Applicable to U.S.A.**

If you believe that your vehicle has a defect which could cause a crash or could cause injury or death, you should immediately inform the National Highway Traffic Safety Administration (NHTSA) in addition to notifying

Audi of America, Inc.
2200 Ferdinand Porsche Drive
Herndon, VA 20171

If NHTSA receives similar complaints, it may open an investigation, and if it finds that a safety defect exists in a group of vehicles, it may order a recall and remedy campaign. However, NHTSA cannot become involved in individual problems between you, your dealer, or Audi of America, Inc. ▶

To contact NHTSA, you may call the Vehicle Safety Hotline toll-free at 1-888-327-4236 (TTY: 1-800-424-9153); go to <http://www.safercar.gov>;

or write to:

Administrator NHTSA
1200 New Jersey Ave.,
S.E. West Building
Washington, DC
20590.

You can also obtain other information about motor vehicle safety from <http://www.safercar.gov>.

Applicable to Canada

If you live in Canada and you believe that your vehicle has a defect that could cause a crash, injury or death, you should immediately inform Transport Canada, Defect Investigations and Recalls. You should also notify Audi Canada.

Canadian customers who wish to report a safety-related defect to Transport Canada, Defect Investigations and Recalls, may either call Transport Canada toll-free at:

Tel.: 1-800-333-0510 or
Tel.: 1-819-994-3328 (Ottawa region and from other countries)
TTY for hearing impaired:
1-888-675-6863

or contact Transport Canada by mail at:

Transport Canada
Motor Vehicle Safety Investigations Laboratory
80 Noel Street
Gatineau, QC
J8Z 0A1

For additional road safety information, please visit the Road Safety website at:

English:

<http://www.tc.gc.ca/eng/motorvehiclesafety/menu.htm>

French:

<http://www.tc.gc.ca/fra/securiteautomobile/menu.htm>

Technical data

Identification data

Vehicle Identification Number

The Vehicle Identification Number (VIN) is located in the following areas:

- Applies to MMI: Select on the home screen: **VEHICLE > Settings & Service > Vehicle information**.
- At the front behind the windshield
- Stamped under the carpet under the right front seat

Notes about technical data

The values may vary based on special equipment as well as market-specific equipment and measuring methods.

Please note that the specifications listed in the vehicle documentation always take precedence.

Tips

Any technical data that is missing was not available at the time of printing.

Vehicle data

Dimensions

	Length (in (mm))	Width (in (mm))	Width across the mirrors (in (mm))	Height at curb weight (in (mm))
A8 L	209.5 (5,320)	76.6 (1,945)	83.8 (2,130)	58.3 (1,482) - 58.7 (1,490)
S8 L	209.5 (5,320)	76.6 (1,945)	83.8 (2,130)	58.5 (1,487) - 58.6 (1,489)

Capacities

	Approximate capacities
Fuel tank	21.7 gal (82 L)
Windshield/headlamp washer system*	6.1 qt (5.8 L)

A/C system refrigerant oil

The exact type and amount of refrigerant oil in the A/C system is specified on the sticker on the refrigerant compressor.

	Approximate capacities	Tolerance
Refrigerant oil	130 / 140 g ^{a)}	+/- 10 g

^{a)} The specifications depend on vehicle equipment.

Weights

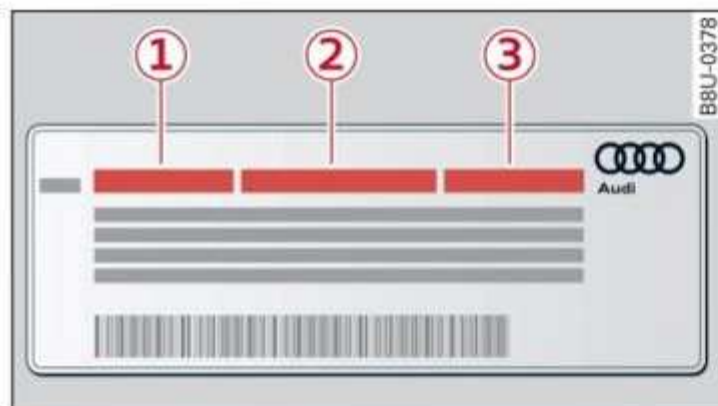

Fig. 194 Safety certificate

Gross Vehicle Weight Rating (GVWR)

The maximum permitted total weight **①** of the vehicle is listed on the safety certificate on the side area of the door or on the driver's door pillar.

Gross Axle Weight Rating (GAWR)

The maximum permitted load on the front axle **②** or the rear axle **③** is listed on the safety certificate on the side area of the door or on the driver's door pillar.

Load

The maximum permitted load is listed on the tire pressure label on the driver's door pillar.

Roof load

The maximum permissible roof load is 165 lbs (75 kg).

Other information

Online Car Care

Applies to: vehicles with Online Car Care

If new messages from Online Car Care are available, they will be displayed in the MMI when you switch on the ignition.

- Applies to: MMI: To access Online Car Care messages at a later time, select on the home screen: **VEHICLE > Settings & Service > Online Car Care.**

Special service events, service measures, and recalls regarding your vehicle will be displayed via Online Car Care.

WARNING

- Always follow the information found in ⇨  in *General information on page 203.*
- Recalls by the manufacturer must be performed. Failing to adhere to this requirement can void the vehicle's operating license. Failing to perform measures can result in impaired functionality, which increases the risk of an accident.

Note

- Always follow the information found in ⇨  in *General information on page 203.*
- Recalls by the manufacturer must be performed. If they are not, there is a risk of vehicle damage.

Brands and licenses

This manual does not contain any symbols, such as ® or ™, to identify trademarks or registered trademarks. However, the absence of these symbols does not constitute a waiver of any rights associated with these names.

Apple, iPhone, iPod touch, Apple CarPlay, Lightning, and iTunes Radio are trademarks of Apple Inc.

Other product and manufacturer names may be trademarks of their respective owners.

Disposal instructions

General information

Follow the legal regulations for disposal of electrical/electronic devices and the vehicle that are applicable in your country, as well as the information that follows.

Batteries

Handling batteries that contain lithium (Li) requires special care. For example, they must not be overheated or damaged. Battery components can be harmful to human and animal health and can accumulate in the environment. To reduce this risk, follow the legal regulations for disposal of batteries that are applicable in your country.

Vehicle

Certain components in your vehicle such as undeployed airbag modules, pretensioners and remote control batteries may contain Perchlorate Material – special handling may apply, See www.dtsc.ca.gov/hazardouswaste/perchlorate. When the vehicle or parts of the restraint system including airbag modules and safety belts with pretensioners are scrapped, all applicable laws and regulations must be observed. Your authorized Audi dealer is familiar with these requirements and we recommend that you have your dealer perform this service for you.

Declaration of compliance for telecommunications equipment and electronic systems

Your vehicle may be equipped with various radio systems, depending on vehicle equipment. The manufacturer is not liable for radio malfunctions that are caused by unauthorized changes to the equipment.

FCC Part 15.19

This device complies with part 15 of the FCC Rules. Operation is subject to the following two conditions: (1) This device may not cause harmful ►

interference, and (2) this device must accept any interference received, including interference that may cause undesired operation.

FCC Part 15.21

Changes or modifications not expressly approved by the party responsible for compliance could void the user's authority to operate the equipment.

RSS-Gen

This device contains licence-exempt transmitter(s)/receiver(s) that comply with Innovation, Science and Economic Development Canada's licence-exempt RSS(s). Operation is subject to the following two conditions:

- (1) This device may not cause interference; and
- (2) This device must accept any interference, including interference that may cause undesired operation of the device.

RSS 102

Radiofrequency radiation exposure Information: This equipment complies with FCC and ISED radiation exposure limits set forth for an uncontrolled environment. This equipment should be installed and operated with minimum distance of 20 cm (8 inches) between the radiator and your body. This transmitter must not be co-located or operating in conjunction with any other antenna or transmitter.

Class B devices

This equipment has been tested and found to comply with the limits for a Class B digital device, pursuant to part 15 of the FCC Rules. These limits are designed to provide reasonable protection against harmful interference in a residential installation. This equipment generates, uses and can radiate radio frequency energy and, if not installed and used in accordance with the instructions, may cause harmful interference to radio communications. However, there is no guarantee that interference will not occur in a particular installation. If this equipment does cause harmful interference to radio or television reception, which can be determined by turning the equipment off and on, the user is encouraged to try to

correct the interference by one or more of the following measures:

- Reorient or relocate the receiving antenna.
- Increase the separation between the equipment and receiver.
- Connect the equipment into an outlet on a circuit different from that to which the receiver is connected.
- Consult the dealer or an experienced radio/TV technician for help.

This Class B digital apparatus complies with Canadian ICES-003.

Integrated Toll Module* – FCC (USA) and ISED (Canada)

This device complies with FCC rules part 90 and Innovation, Science, and Economic Development Canada RSS-137. Operation is subject to the following two conditions: (1) This device may not cause harmful interference, and (2) This device must accept any interference that may be received including interference that may cause undesired operation. **WARNING:** The transmitter has been tested and complies with FCC and ISED rules. Changes or modifications not expressly approved by the party responsible for compliance could void the user's authority to operate the device.

This equipment complies with FCC and ISED radiation exposure limits set forth for an uncontrolled environment. End Users must follow the specific operating instructions for satisfying RF exposure compliance. This transmitter must be at least 20 cm (8 inches) from the user and must not be co-located or operating in conjunction with any other antenna or transmitter.

Tips

Additional information, updates, and supplements about the radio systems or product names are based on the vehicle equipment and country can be found on the following website: www.audi.com/generalinfo

A

A/C cooling mode 98
 A/C system refrigerant oil 323
 ABS
 refer to Anti-Lock Braking System (ABS) 122
 Accelerator pedal 107
 also refer to Accelerator pedal 107
 Accessories 321
 Active combination filter 97, 101
 Active suspension 118
 Adaptive cruise assist 144
 Cleaning the sensors 295
 Adaptive cruise control
 Predictive control 150
 Adaptive speed assist
 refer to Adaptive cruise assist 144
 Adjusting the air distribution 98
 Adjusting the brightness 61
 Adjusting the sound 246
 Adjusting the temperature 98
 Adjusting the vents 100
 Adjusting the volume 33
 Adjusting the volume (announcements) 246
 Adjusting the welcome sound 246
 Airbag system 81
 Air quality index 101
 Air quality indicator 101
 Air suspension 118
 Alarm system
 refer to Anti-theft alarm system 41
 Alignment pin (changing the wheel) 300
 All-weather lights 56
 All season tires 285
 All wheel drive
 refer to quattro 121
 Android Auto
 refer to Smartphone interface 243
 Anti-Lock Braking System (ABS) 122
 Anti-Slip Regulation 122
 Anti-theft alarm system 41
 Anti-theft wheel bolts 301
 App 206
 Apple CarPlay
 refer to Smartphone interface 243

AQI

refer to Air quality indicator 101

Aspect ratio

Video 238

ASR

refer to Anti-Slip Regulation 122

Assist systems on and off 131

Audi adaptive light 56

Audi connect

refer to connect 203, 204

Audi connect Remote & Control 206

Audi drive select 117

Audio files 235

Audi Online Owner's Manual 6

Audi phone box 192

Audi pre sense 159

 Messages 162

Audi pre sense front 160

Audi virtual cockpit

refer to Instrument cluster 15

AUTO

 Automatic headlights 56

 Climate control system 98

Auto Lock (central locking) 37

Automatic climate control system

refer to Climate control system 97

Automatic luggage compartment lid 46, 47

Automatic transmission 105

 Parking lock emergency release 108

Automatic wipe/wash system 63

Average consumption 18

Average speed 18

B

Band

refer to Frequency band 224

Battery

 Charging (12 volt vehicle battery) 266

 Vehicle battery (12 volt) 264

 Winter operation (12 volt vehicle battery) 264

Battery (mobile device)

 Charging via USB 193, 234

 Wireless charging 193

Blinds

refer to Panoramic glass roof 51

Blower 98

- Bluetooth
 - Audio player 232
 - Connecting a device 248
 - Connecting a mobile phone 190
 - Deleting a device 248
 - Device overview 247
 - Disconnecting a device 248
 - Displaying profiles 248
 - Selecting a device 248
 - Specifying a favorite 248
 - Boost 18
 - Boost pressure indicator 18
 - Brake fluid
 - Checking the brake fluid level 262
 - Brakes 112
 - Brake fluid 262
 - Emergency braking function 114
 - Hot 115
 - New brake pads 112
 - Brands 325
 - Break-in security feature 41
 - Breaking in
 - New brake pads 112
 - New tires 276
 - Bulb replacement 313
 - Business address 219
- C**
- California Proposition 65 Warning 254
 - Battery specific 264
 - Call list 196
 - Cameras 128
 - Locations 130
 - Capacities 323
 - Car key 42
 - Car wash 293
 - Catalytic converter 253
 - Cell phone
 - refer to Telephone* 190
 - Cell phone compartment
 - refer to Audi phone box* 192
 - Central locking 37
 - Auto Lock 37
 - Convenience key 43
 - Convenience opening and closing 50
 - Luggage compartment lid 46
 - Mechanically unlocking and locking 41
 - Messages 39
 - Remote control key 43
 - Setting 38
 - Vehicle key 43
 - Central locking switch 39
 - Ceramic brakes 112
 - Certification 325
 - Changing light bulbs 313
 - Charging
 - refer to Power sources* 91
 - Charging wirelessly 193
 - Child safety lock
 - Climate control system controls in the rear 49
 - Power windows 49
 - Rear doors 49
 - Child safety seats 85
 - Securing to the top tether anchor 89
 - Securing with a safety belt 88
 - Securing with LATCH 87
 - Cleaning 293
 - Cleaning artificial leather 296
 - Cleaning carbon components 295, 297
 - Cleaning controls 296
 - Cleaning decorative parts and trim 295, 296
 - Cleaning exhaust tail pipes 295
 - Cleaning microfiber 296
 - Cleaning plastic parts 296
 - Cleaning rubber seals 295
 - Cleaning textiles 296
 - Climate control system 97
 - Climate control system controls in the rear
 - Child safety lock 49
 - Closing
 - Automatic luggage compartment lid 46
 - Convenience closing 50
 - Hood 255
 - Luggage compartment lid 46
 - Luggage compartment lid with foot motion 47
 - Panoramic glass roof 51
 - Rear window sunshade 52
 - Sunshade (roof) 51
 - Sunshade (windows) 49
 - Windows 49
 - Closing aid (power closing doors) 37
 - Cockpit dimming 61

- Cockpit (overview) 9
- Combustion engine 109
- Comfort entry 118
- Coming home/Leaving home
refer to Entry/exit lighting 58
- Coming to a stop 104
- Compact spare tire 304
- Compartments 92
- Compass in the mirror 65
- Compliance 325
- Conference call 198
- Configuration wizard 22
- connect 203
- Data plans 208
- Data Privacy 317
- Emergency call 209
- Infotainment 204
- Infotainment services 205
- Online roadside assistance 210
- Vehicle control services 206
- Connected devices 247
- Connections
refer to Media 232, 235
- Consumer information 319
- Consumption
 Reducing 109
- Consumption (fuel) 18
- Contacts
 Importing and exporting 200
- Updating in the MMI 200
- also refer to* Directory 196
- Convenience key 37
- Convenience closing 50
- also refer to* Vehicle key 42
- Convenience opening and closing
 Sunshade 50
- Windows or panoramic glass roof 50
- Coolant temperature display 17
- Cooled glove compartment 92
- Cooling mode 98
- Cooling system
 Adding coolant 261
- Checking the coolant level 261
- Coolant 260
- Cornering light 56
- Cross traffic assist (intersection assistant) . . 166
- Cruise control system 141
- Cup holders 92
- Current consumption 18
- Curve tilting function 118
- Customer information 325
- Customer measures 325
- D**
- Data module
 Serial number (IMEI) 199
- Data plans 208
- Data Privacy 317
- Date 18
- Setting 246
- Daytime running lights 56
- Declaration of compliance 325
- Demo mode
 refer to Presentation mode 222
- Determining correct load limit 283
- Device overview 247
- Digital compass 65
- Dimensions 323
- Dimming the exterior mirrors 62
- Dimming the rearview mirror 62
- Directory 196
- Business card 197
- Display
 Cleaning 296
- Disposal 319
- Distance 18
- Distance warning 156
- Doors
 Child safety lock 49
- Door contact switch 60
- Mechanically unlocking and locking 41
- Power closing/closing aid 37
- Drive
 Audi drive select 117
- Driver assistance display 16, 19, 146
- Driver assistance menu 131
- Driver assist system messages 128
- Driver information system 16
- Drives
 refer to Media 232, 235

- Drive select
refer to Audi drive select 117
- Drive system 109, 111
- Driving down hills 115
- Driving program 106, 155
- Driving through water 115
- Driving time 18
- Driving tips
 Driving through water 115
 Efficient driving 109
 Uphill and downhill 115
- Driving up hills 115
- Dust filter
refer to Active combination filter 97, 101
- Dynamic all-wheel steering 120
- E**
- E-mail 201
- EDL
refer to Electronic Differential Lock 122
- EDR
refer to Event Data Recorder (EDR) 314
- Efficiency assist 142
 Predictive control 150
- Efficiency assist menu 143
- Electrical system 263
- Electromechanical parking brake 114
- Electronic Differential Lock 122
- Electronic immobilizer 43
- Electronic Stabilization Control 122
- Embedded SIM card 204
- Emergency assist 167
- Emergency assistance 300
- Emergency braking function 114
- Emergency call 199, 209
- Emergency flashers 59
- Emergency mode 108
- Emergency operation
 Doors 41
 Panoramic glass roof 52
- Emissions control system 253
- Energy consumers 19
- Energy management 110
- Engine
 Breaking in 109
 Coolant 260
 Emergency stop 103
 Jump starting 304
 Start/Stop system 110
 Starting/stopping 103
- Engine compartment
 Opening and closing the hood 255
 Overview 256
 Safety precautions 253
- Engine oil
 Adding 256
 Changing 259
 Checking oil level 256
 Consumption 256
 Indicator light 257
 Replacement intervals 267
 Temperature display 18
 Type 256
- Engine sound
 Audi drive select 117
- Engine start system 104
- Engine stop
refer to Start/Stop system 110
- Entering a destination 213
 Destination from the map 216
- Entry/exit lighting 58
- Entry assistance 70
also refer to Exit assistance 70
- Environment
 Unleaded gasoline 250
- ESC
refer to Electronic Stabilization Control 122
- ESC Sport 123
- eSIM
refer to Embedded SIM card 204
- Event Data Recorder (EDR) 314
- Exit assistance 70
- Exit warning 165
- Exterior antenna 193
- Exterior lighting 56
- Exterior mirrors 61
 Folding settings 38
- External voice operation 32

F

Factory default settings	
Multi Media Interface	247
Fastest route	213
Favorites	
Bluetooth	248
Navigation	214
Podcast	229
Telephone	196
Federal Communications Commission (FCC) .	325
File formats (media drives)	238
Floor mat	67
Fog (windows)	99
Folding tray table	93
Foot heating	99
Footrests in rear	74
Footwell temperature	101
For the sake of the environment	
Disposing of engine oil	259
Fueling	251
Leaks	255
Fragrance	100, 101
Free text search	
Media	237
Radio	226
Freeze protection	
Coolant	260
Windshield washer system	267
Frequency band	224
<i>also refer to</i> Frequency band	224
Front center armrest	70
Front collision warning	
<i>refer to</i> Audi pre sense front	159
Front passenger's seat adjustment	
Rear	72
Front passenger's seat adjustment	
Front	70
Rear	70
Front wiper blades	
Changing	64
Cleaning	64
Fuel	250
Additives	251
Capacities	323
Current consumption	18
Fuel gauge	15

Gasoline	250
Reducing fuel consumption	109
Fueling	
Capacities	323
Fuel filler door	251

G

Garage door opener	53
Garment hooks	94
Gasoline	250
Additives	251
Gasoline mixture	250
GAWR	
<i>refer to</i> Gross Axle Weight Rating (GAWR) .	324
Gears	105
Glossary of tire and loading terminology . .	272
Glove compartment	94
Cooled	92
Valet parking	52
Gross Axle Weight Rating (GAWR)	324
Gross Vehicle Weight Rating (GVWR)	324
GVWR	
<i>refer to</i> Gross Vehicle Weight Rating (GVWR)	324

H

Hands-free	191
Rear Seat Remote	194
Hands Free Profile	191
Head-up display	
Adjusting	30
Adjusting the brightness	61
Operating	30
Headlamp washer system	
Capacities	323
Headlight range control	56
Headlights	
Cleaning	294
Headlight range control	56
Washer system	63
Washer system (filling washer fluid)	267
Head restraints	
Adjusting	76
Removing and installing	76
Heated rear window	99
Heated steering wheel	101

- Heating 97
- HFP
refer to Hands Free Profile 190
- High beams
 High beam assistant 57
- Highway lights 56
- Hill descent control 115
- Hill hold assist 105
- holoride interface 241
- Home
refer to Home address 219
- Home address 219
- HomeLink
refer to Garage door opener 53
- Home screen 21
- Horn 9
- Hotspot
refer to Wi-Fi 207
- I**
- Ignition
 Switching on and off 103
- Imbalance (wheels) 278
- Immobilizer
refer to Electronic immobilizer 42
- Indicator lights 10
- Inspection interval
refer to Service interval display 267
- Instrument cluster 15
 Adjusting the layout 16
 Cleaning 296
 Engine code 249
 Malfunction 15
 On-board computer 18
 Operating 16
 Service interval display 267
 Software information 249
 Switching tabs 16
 Switching the view 16
 Vehicle functions 18
 Version information 249
- Instrument illumination 61
- Integrated assistance 22
- Integrated Toll Module 139
- Intelligent search
 Navigation 213
- Interference-Causing Equipment Standard (ICES) 326
- Interior lighting 60
- Interior monitoring 41
- Intermittent mode (windshield wipers) 63
- International travel 208
- Internet
refer to connect 203, 204
- Internet radio
refer to Online radio 228
- Intersection assistant 166
- Ionizer 99
- iPhone
refer to USB ports with charging function . 233
- J**
- Jump starting 304
- K**
- Key 37, 42
 Convenience opening and closing 50
 Key replacement 42
 Mechanical key 42
 Not recognized 104
 PANIC button 42
 Replacing the battery 44
 Unlocking and locking 43
- Key user 35
- Kick-down 107
- L**
- Lane assist
refer to Lane departure warning 148
refer to Lane guidance (Adaptive cruise assist) 148
- Lane departure warning 157
 Cleaning the camera area 295
- Lane guidance (Adaptive cruise assist) 148
- Lap timer 136
also refer to Lap timer 136
- Laser scanner 128
 Cleaning 295
- LATCH (securing child safety seats) 87
- Leather care and cleaning 297

- Legal information
 - License subscriptions 248
 - Software information 248
 - Software licenses 248
 - Version information 248
- Leg support 72
- License plate
 - Securing 321
- License plate bracket 321
- Lifting points (vehicle jack) 302
- Light/rain sensor
 - Headlights 56
 - Intermittent mode (windshield wipers) 63
- Lighting 56
 - Exterior 56
 - Interior 60
- Listening to music
 - refer to Media* 232, 235
- Load 324
- Local users 34
- Locking and unlocking
 - By remote control 43
 - Using the lock cylinder 41
 - With the convenience key 43
- Low beam headlights 56
- LTE
 - refer to Exterior antenna* 193
- Luggage
 - Luggage compartment lid 45
- Luggage compartment 94
 - Power sources 91
 - Valet parking 52
 - also refer to Luggage compartment* 94
- Luggage compartment lid 45, 48
 - Closing button 46
 - General information 45
 - Manually unlocking 48
 - Opening and closing 46
 - Opening and closing with foot motion 47
 - Opening from the inside in an emergency .. 48
 - Power opening and closing 46
- Lumbar support 68, 71
- Maintenance intervals
 - refer to Service interval display* 267
- Malfunction Indicator Lamp (MIL) 253
- Maneuver assist 188
- Manual operation
 - Luggage compartment lid 47, 48
- Manual shifting 107
- Map
 - Changing the map scale 216
 - Display 217
 - Operating 216
 - Selecting a destination 216
- MAP
 - refer to Message Access Profile* 200
- Map preview 215
- Map update 220
 - Online 220
 - USB connection 221
- Message function 68, 71
 - Front 69
- Mechanical key 42
- Media 232, 235
 - Supported formats 238
- Media center 235
- Memory function 80
- Menu language
 - refer to Setting the language* 246
- Menu of the efficiency assist 143
- Menu paths 21
- Message Access Profile 200
- Messages 200
- Mild hybrid drive system 109
- Mirror compass 65
- Mirrors
 - Adjusting exterior mirrors 61
 - Dimming 62
 - Vanity mirror 62
- MMI
 - refer to Multi Media Interface* 22
- Mobile device
 - refer to Telephone* 190
- Mobile device reminder signal 194
- Mountain passes 115
- Mountain roads 115
- Multifunction steering wheel
 - Buttons 16, 33

M

Maintenance 319

- Operating 16
 - Programming buttons 33
 - Voice recognition system 31
 - Multi Media Interface 22
 - Menus and symbols 23
 - Operating 20, 23
 - Switching the displays on or off 22
 - Muting 33
 - myAudi 34, 205
 - myAudi navigation 212, 215
 - myAudi PIN 35
 - myAudi users 34
- N**
- Narrow areas 155
 - Natural leather care and cleaning 297
 - Navigation 212
 - Better route 222
 - Changing the scale 216
 - Destination details 215
 - Favorites 219
 - also refer to* Map 216
 - Navigation database
 - Version information 248
 - Navigation (instrument cluster) 218
 - NHTSA 321
 - Night vision assist 137
 - Cleaning the camera 295
 - Notification center 25
- O**
- Octane rating (gasoline) 250
 - Odometer 17
 - Resetting 17
 - Office address
 - refer to* Business address 219
 - OFF (climate control system) 98
 - Oil
 - refer to* Engine oil 256
 - On-board computer 18
 - On Board Diagnostic System (OBD) ... 253, 314
 - Online
 - Car care 325
 - Measures 325
 - Service 325
 - Online map
 - refer to* Satellite map 220
 - Online media 233
 - Online Owner's Manual 6
 - Online radio 228
 - also refer to* Online radio 228
 - Online roadside assistance 210
 - Online services
 - refer to* connect 203, 204
 - Online traffic information 222
 - Opening 37
 - Automatic luggage compartment lid 46
 - Convenience opening 50
 - Fuel filler door 251
 - Hood 255
 - Luggage compartment lid 46
 - Luggage compartment lid with foot motion . 47
 - Panoramic glass roof 51
 - Rear window sunshade 52
 - Sunshade (roof) 51
 - Sunshade (windows) 49
 - Windows 49
 - Opening and closing
 - refer to* Unlocking and locking 37, 43
 - Opening the door 40
 - Operating
 - Head-up display 30
 - Instrument cluster 16
 - Multifunction steering wheel 16
 - Multi Media Interface 20, 23
 - Rear Seat Remote 20, 29
 - Text input 27
 - Touch display 20
 - Voice recognition system 31
 - Options
 - Media 238
 - Radio 229
 - Overview (cockpit) 9
 - Owner's Manual
 - Accessing the digital version 6
- P**
- Paint damage 295
 - PANIC button 42
 - PANIC function 42

- Panoramic glass roof 51
 Convenience opening and closing 50
 Emergency closing 52
 Quick opening and closing 51
- Parental control
 Rear Seat Remote 29
- Park assist plus 179
- Parking 104
- Parking aid 169
 Adjusting the volume 171
 Automatic activation 170
 Cleaning the sensors and camera 295
 Park assist plus 179
 Parking aid plus 169
 Parking space search 177
 Peripheral cameras 172
 Rear cross-traffic assist 176
 Rearview camera 172
 Remote controlled parking 183
 Switching off maneuver assist 189
- Parking aid menu 131
- Parking and maneuvering 169
- Parking brake
refer to Electromechanical parking brake 114
- Parking lights 56
- Parking lock emergency release 108
- Particulate matter sensor 101
- Pass-through 95
- Pedals 107
- Pedestrian detection 137
- Perchlorate 319
- Peripheral cameras 172
- Personal hotspot 204
- Phone
 Connecting a second mobile device 191
 Disconnecting a mobile device 192
- Phonebook
refer to Directory 196
- PIN
 4-digit myAudi PIN 34
- Playback
 Media 235
 Radio 225
- Podcast
refer to Online radio 228
- Polishing 295
- Pollen filter
refer to Active combination filter 97, 101
- Power closing (doors) 37
- Power sources 91, 234
- Power window malfunction 49
- Power windows 49
 Malfunction 49, 50
- Predictive control 150
- Predictive messages 143
- Predictive route guidance 218
- pre sense
refer to Audi pre sense 159
- Presentation mode 223
- Presets
 Radio 227
- Presets list
refer to Presets 227
- Pressure
 Tire pressure monitoring system 288, 289
 Tires 280
- Profile picture 34
- Protecting 295
- Pyrotechnic elements 319
- Q**
- quattro 121
 Selective wheel torque control 122
- R**
- Radio 224
 Radio text 227
 Station list 224
- Radio communications equipment 321
- Radio equipment 321
- Radio Standards Specification (RSS) 325
- Rail carrier 118
- Rain/light sensor
 Headlights 56
 Intermittent mode (windshield wipers) 63
- Random
refer to Shuffle 236
- Range 18
- Reading lights 60
- Rear cross-traffic assist 176
- Rear fog lights 56

Rear lid		
<i>refer to</i> Luggage compartment lid	46	
Rear Seat Remote	28	
Connected devices	195	
Legal information	248	
Making phone calls	194	
Menus and symbols	29	
Operating	20, 29	
Software information	248	
Rear seats	71	
Rear shelf		
<i>refer to</i> Storage area behind the rear head		
restraints	93	
Rearview camera	172	
Rear window defogger	99	
REAR (climate control system)	98	
Recall	325	
Recirculation mode	99	
Reclining position	73	
Reclining seat system	73	
Recuperation	19	
Refrigerant oil	323	
Refrigerator		
Cleaning	297	
Refueling	251	
Fuel filler door emergency release	253	
Remote access authorization (key user)	35	
Remote control		
Garage door opener	53	
Remote control key	42	
Convenience opening and closing	50	
Key replacement	42	
LED	44	
PANIC function	42	
Replacing the battery	44	
Unlocking and locking	43	
<i>also refer to</i> Vehicle key	42	
Remote controlled parking	183	
Remote park assist plus		
<i>refer to</i> Remote controlled parking	183	
Removing the caps (wheel bolts)	301	
Repairs	319	
Replacement key	42	
Replacement parts	321	
Replacing fuses	309	
Replacing the battery		
12 volt vehicle battery	264	
Vehicle key	44	
Reporting Safety Defects	321	
Rims	284	
Cleaning	295	
Road carrier	118	
Rolling	104	
Rolling ability		
Electromechanical parking brake	114	
"N" selector lever position	106	
Roof		
<i>refer to</i> Panoramic glass roof	51	
Roof load	324	
Roof rack	95	
<i>also refer to</i> Roof rack	95	
Route guidance		
Stopping	216	
<i>also refer to</i> Navigation	212	
Running direction (tires)	303	
S		
Safety belts	77	
Cleaning	296	
Locking	88	
Securing child safety seats	88	
Satellite map	220	
Saving fuel		
Energy consumers	19	
Recuperation	19	
Screen		
<i>refer to</i> Touch display	20	
Screwdriver	300	
Search function		
<i>refer to</i> Free text search	226, 237	
<i>refer to</i> Intelligent search	213	
Seat heating	99	
Seats		
Adjusting the front seats	68	
Adjusting the rear seats	71	
Cleaning	296	
Front passenger's seat adjustment	72	
Front passenger's seat adjustment	70	
Head restraints	75	
Massage function	68	
Memory function	80	

- Resetting the position 70
- Storing a seat profile 80
- Seat ventilation 99
- Selecting a source
 - Media 235
 - Radio 225
- Selector lever 105
- Self-learning navigation
 - refer to Predictive route guidance* 218
- Sensors
 - Coverage areas 128
 - Locations 130
- Service interval
 - refer to Service interval display* 267
- Service interval display 267
- Service measures 325
- Setting measurement units 246
- Settings 246
 - Announcements and tones 246
 - Bluetooth 246
 - Date and time 246
 - Directory 199
 - E-mail 201
 - Language 246
 - Measurement units 246
 - Media 238
 - Navigation 222
 - Radio 230
 - Sound 246
 - System 246
 - Telephone 199
 - Text messages 200
 - Time zone 246
 - Wi-Fi 207
 - Wi-Fi hotspot 207
- Setting the language 246
- Setting the time 246
- Shift paddles 107
- Ship carrier 118
- Shortcut
 - refer to Shortcuts* 26
- Shortcuts 26
- Shuffle 236
- Side assist 163
 - Cleaning the sensors 295
- SIM card 204
- Sliding/tilting sunroof
 - refer to Panoramic glass roof* 51
- Smart Favorites
 - refer to Presets* 227
- Smartphone
 - refer to Telephone* 190
- Smartphone interface 243
 - Legal information 249
- Snow chains 286
- Socket
 - refer to Power sources* 91
- Software information
 - Legal information 248
- Software version (MMI)
 - Version information 248
- Sound
 - refer to Adjusting the sound* 246
- Space-saving spare tire (compact spare tire) . 304
- Spare tire 304
- Speed limit information
 - refer to Traffic sign recognition* 133
- Speed limits
 - refer to Traffic sign recognition* 133
- Speedometer 15
- Speed warning system 133
- SPIN
 - Protection 35
- Sport differential 121
- Start/Stop system 110
 - Messages 111
 - Switching off and on 111
- Starting to drive 104
- Starting (engine) 111
- Steering 120
 - Audi drive select 117
 - also refer to Steering* 120
- Steering lock 103, 120
- Steering wheel
 - Adjusting 75
 - Shift paddles 107
 - Steering wheel heating 101
 - also refer to Multifunction steering wheel* . 16
- Steps for determining correct load limit . . . 283
- Stopover (navigation) 216
- Stopping 104
- Stopping (engine) 111

Storage	92	Temperature display	
Storage area behind the rear head restraints	93	Coolant	15
Stored stations		Outside temperature	18
<i>refer to Presets</i>	227	Tethering	204
Streaming		<i>also refer to Wi-Fi</i>	207
<i>refer to Online media</i>	233	Text input	27
Sunshade		Text messages	200
Rear side windows	50	<i>also refer to Text messages</i>	200
Rear window	52	Themes	241
Roof	51	Tie-downs	95
<i>also refer to Panoramic glass roof</i>	51	Tightening specification	
Sun visors	62	Wheel bolts	304
Surface heating	101	Tightening specification (wheel bolts)	304
Suspension	118	Time	18
Audi drive select	117	tiptronic	
Swapping calls	198	<i>refer to Manual shifting</i>	107
Swerve assist	161	Tires	269
Symbols		Labeling	270
Media	236	Load index	270
Navigation	216	Loose wheel warning	285
Radio	225, 226	Low-profile tires	286
<i>also refer to Indicator lights</i>	10	Manufacture date	270
SYNC (climate control system)	98	Replacing	300
System settings	246	Service life	278
		Speed rating	270
		Tire pressure	280
		Tire pressure monitoring sys-	
		tem	287, 288, 289
		Tire pressure table	281
		Tire pressure (trailer mode)	124
		Treadwear indicators	278
		Unidirectional	271, 303
		Uniform tire quality grading	286
		Tires and wheels	
		Glossary of tire and loading terminology	272
		Tires and vehicle load limits	282
		Toll Module	
		<i>refer to Integrated Toll Module</i>	139
		Tools	300
		Tool tips	22
		Top tether anchor (securing the child safety seat)	89
		Touch display	
		Adjusting the brightness	22
		Operating	20
		Touch displays	
		<i>refer to Multi Media Interface</i>	22
T			
Tachometer	15, 17		
Tail lights			
Cleaning	294		
Technical data	323		
Technical modifications	319		
Technical product information	325		
Telephone	190		
Accepting/ending a call	198		
Audi phone box	192		
Charging the battery (USB)	193		
Charging the battery (wireless)	193		
Connecting a mobile phone	190		
Dialing a number	197		
Exterior antenna	193		
Mobile device reminder signal	194		
Options during a phone call	198		
Playing music	232		
Rear Seat Remote	194		

- Towing 306
- Towing loop 307, 308
- Towing protection monitoring 41
- TPMS
- Indicator light 291
 - Tire pressure monitoring system 288, 289
- Traffic information 221
- Online traffic information 222
- Traffic jam assist 149
- Traffic light information 135
- Traffic sign recognition 133
- Traffic signs 136
- Trailer mode
- Trailer hitch 126
- Trailer towing 124
- Tongue weight 124
 - Trailer load 124
- Trailer towing mode
- Air suspension 125
- Turn assist 162
- Turn signals 57
- U**
- Uniform tire quality grading 286
- Unlocking and locking 37
- By remote control 43
 - Using the lock cylinder 41
 - With Audi connect vehicle control 44
 - With the central locking switch 39
 - With the convenience key 43
- Update (software) 247
- Upright position 73
- USB adapter 233
- USB drive
- Supported types/formats 238
- USB port 91
- USB ports with charging function 233, 234
- USB stick
- refer to* USB ports with charging function . 233
- Users
- Local users 34
 - myAudi users 34
- Using residual heat 100
- V**
- Valet parking 52
- Vanity mirror 62, 63
- Vehicle
- Care/cleaning 293
 - Dimensions 323
 - Identification data 323
 - Out of service 299
 - Parking 104
 - Raising 302
 - Securing 104
 - Starting 103
 - Transport 118
 - Unlocking and locking 43
- Vehicle care 293
- Vehicle control services 206
- also refer to* Audi connect Remote & Control 206
- Vehicle Identification Number 323
- Vehicle Identification Number (VIN)
- refer to* Vehicle Identification Number ... 323
- Vehicle jack 300
- Lifting points 302
 - Tire change mode 300
- Vehicle key 37, 42
- Vehicle start system 111
- Vehicle tool kit 300
- Ventilation 97
- VIEW button 16
- VIN
- refer to* Vehicle Identification Number ... 323
- Virtual reality experience
- refer to* holoride interface 241
- Voicemail 197
- Voice recognition system 31
- External 32
 - Operating 31
- W**
- Warning lights
- refer to* Indicator lights 10
- Warning triangle 300
- Washing matte finish paint 293
- Wave band
- refer to* Frequency band 224

Weights	324	Wireless Apple CarPlay	
Wheel bolts	284	<i>refer to Smartphone interface</i>	243
anti-theft	301	Work	
Tightening specification	304	<i>refer to Business address</i>	219
Wheels	269		
Cleaning	295		
Glossary of tire and loading terminology . .	272		
Loose wheel warning	285		
Replacing	300		
Tire pressure monitoring system	288, 289		
Tires and vehicle load limits	282		
Wheel wrench	300		
Wi-Fi	207		
Hotspot settings	207		
Using a hotspot	204, 205		
Wi-Fi network	204		
Wi-Fi tethering	204		
Wild animal recognition	137		
Windows			
Child safety lock	49		
Cleaning and removing ice	296		
Convenience opening and closing	50		
Defrosting	99		
Opening and closing	49		
Power windows	49		
Windshield			
Cleaning	63		
<i>also refer to Windshield</i>	63		
Windshield washer system	63, 267		
Capacities	323		
Windshield wipers	63		
Winter operation			
Car washes	293		
Cooling system	260		
Defrosting the windows	99		
Rear window defogger	99		
Removing ice from windows	296		
Seat heating	99		
Snow chains	286		
Steering wheel heating	101		
Surface heating	101		
Tires	285		
Vehicle battery (12 volt)	264		
Windshield washer system	267		
Winter tires	285		
Wireless Android Auto			
<i>refer to Smartphone interface</i>	243		

These instructions may not be reproduced or translated in whole or in part without written consent of AUDI AG. All rights reserved by AUDI AG.

© 2023 AUDI AG

Owner's Manual
English North America 07.2023
4N1012721BD



4N1012721BD

www.audi.com